

## OUTDOOR UNIT

# SERVICE MANUAL



**No. OBH823  
REVISED EDITION-B**

### Models

<b>MUZ-HR25VF</b>	- <span style="border: 1px solid black; padding: 0 2px;">E1</span> , <span style="border: 1px solid black; padding: 0 2px;">ER1</span> , <span style="border: 1px solid black; padding: 0 2px;">ET1</span>
<b>MUZ-HR35VF</b>	- <span style="border: 1px solid black; padding: 0 2px;">E1</span> , <span style="border: 1px solid black; padding: 0 2px;">ER1</span> , <span style="border: 1px solid black; padding: 0 2px;">ET1</span>
<b>MUZ-HR42VF</b>	- <span style="border: 1px solid black; padding: 0 2px;">E1</span> , <span style="border: 1px solid black; padding: 0 2px;">ER1</span> , <span style="border: 1px solid black; padding: 0 2px;">ET1</span>
<b>MUZ-HR50VF</b>	- <span style="border: 1px solid black; padding: 0 2px;">E1</span> , <span style="border: 1px solid black; padding: 0 2px;">ER1</span> , <span style="border: 1px solid black; padding: 0 2px;">ET1</span>
<b>MUZ-HR60VF</b>	- <span style="border: 1px solid black; padding: 0 2px;">E1</span> , <span style="border: 1px solid black; padding: 0 2px;">ER1</span> , <span style="border: 1px solid black; padding: 0 2px;">ET1</span>
<b>MUZ-HR71VF</b>	- <span style="border: 1px solid black; padding: 0 2px;">E1</span> , <span style="border: 1px solid black; padding: 0 2px;">ER1</span> , <span style="border: 1px solid black; padding: 0 2px;">ET1</span>

Indoor unit service manual  
MSZ-HR-VF Series (OBH822)

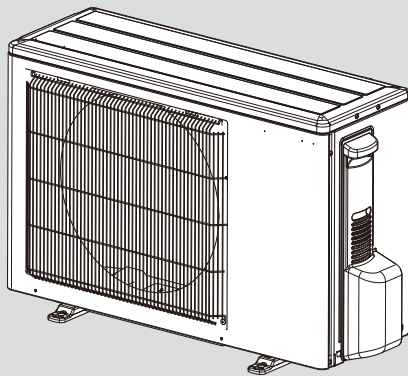

**MUZ-HR42VF  
MUZ-HR50VF**

### CONTENTS

1. TECHNICAL CHANGES .....	2
2. SERVICING PRECAUTIONS FOR UNITS USING REFRIGERANT R32.....	3
3. PART NAMES AND FUNCTIONS.....	5
4. SPECIFICATION.....	6
5. NOISE CRITERIA CURVES .....	7
6. OUTLINES AND DIMENSIONS .....	9
7. WIRING DIAGRAM.....	11
8. REFRIGERANT SYSTEM DIAGRAM .....	14
9. PERFORMANCE CURVES .....	16
10. ACTUATOR CONTROL .....	35
11. SERVICE FUNCTIONS.....	36
12. TROUBLESHOOTING.....	36
13. DISASSEMBLY INSTRUCTIONS.....	58

**PARTS CATALOG (OBB823)**

## Use the specified refrigerant only

### Never use any refrigerant other than that specified.

Doing so may cause a burst, an explosion, or fire when the unit is being used, serviced, or disposed of.

Correct refrigerant is specified in the manuals and on the spec labels provided with our products.

We will not be held responsible for mechanical failure, system malfunction, unit breakdown or accidents caused by failure to follow the instructions.

### Revision A:

- MUZ-HR60/71VF-  E1,  ET1 have been added.

### Revision B:

- MUZ-HR60/71VF-  ER1 have been added.

### <Preparation before the repair service>

- Prepare the proper tools.
- Prepare the proper protectors.
- Provide adequate ventilation.
- After stopping the operation of the air conditioner, turn off the power-supply breaker and remove the power plug.
- Discharge the capacitor before the work involving the electric parts.

### <Precautions during the repair service>

- Do not perform the work involving the electric parts with wet hands.
- Do not pour water into the electric parts.
- Do not touch the refrigerant.
- Do not touch the hot or cold areas in the refrigeration cycle.
- When the repair or the inspection of the circuit needs to be done without turning off the power, exercise great caution not to touch the live parts.

## 1

## TECHNICAL CHANGES

MUZ-HR25VF -  E1,  ER1,  ET1

MUZ-HR35VF -  E1,  ER1,  ET1

MUZ-HR42VF -  E1,  ER1,  ET1

MUZ-HR50VF -  E1,  ER1,  ET1

MUZ-HR60VF -  E1,  ER1,  ET1

MUZ-HR71VF -  E1,  ER1,  ET1

1. New model

### Servicing precautions for units using refrigerant R32



This unit uses a flammable refrigerant.

If refrigerant leaks and comes in contact with fire or heating part, it will create harmful gas and there is risk of fire.

- Do not use means to accelerate the defrosting process or to clean, other than those recommended by the manufacturer.
- The appliance shall be stored in a room without continuously operating ignition sources (for example: open flames, an operating gas appliance or an operating electric heater.)
- Do not pierce or burn.
- Be aware that refrigerants may not contain an odor.
- Pipe-work shall be protected from physical damage.
- The installation of pipe-work shall be kept to a minimum.
- Compliance with national gas regulations shall be observed.
- Keep any required ventilation openings clear of obstruction.
- Servicing shall be performed only as recommended by the manufacturer.
- The appliance shall be stored so as to prevent mechanical damage from occurring.

**Basic work procedures are the same as those for conventional units using refrigerant R410A. However, pay careful attention to the following points.**

1. Information on servicing
  - ① Checks on the Area
 

Prior to beginning work on systems containing flammable refrigerants, safety checks are necessary to ensure that the risk of ignition is minimized.
  - ② Work Procedure
 

Work shall be undertaken under a controlled procedure so as to minimize the risk of a flammable gas or vapor being present while the work is being performed.
  - ③ General Work Area
 

All maintenance staff and others working in the local area shall be instructed on the nature of work being carried out. Work in confined spaces shall be avoided. The area around the workspace shall be sectioned off. Ensure that the conditions within the area have been made safe by control of flammable material.
  - ④ Checking for Presence of Refrigerant
 

The area shall be checked with an appropriate refrigerant detector prior to and during work, to ensure the technician is aware of potentially toxic or flammable atmospheres. Ensure that the leak detection equipment being used is suitable for use with all applicable refrigerants, i.e. non-sparking, adequately sealed or intrinsically safe.
  - ⑤ Presence of Fire Extinguisher
 

If any hot work is to be conducted on the refrigeration equipment or any associated parts, appropriate fire extinguishing equipment shall be available to hand. Have a dry powder or CO2 fire extinguisher adjacent to the charging area.
  - ⑥ No Ignition Sources
 

No person carrying out work in relation to a refrigeration system which involves exposing any pipe work shall use any sources of ignition in such a manner that it may lead to the risk of fire or explosion. All possible ignition sources, including cigarette smoking, should be kept sufficiently far away from the site of installation, repairing, removing and disposal, during which refrigerant can possibly be released to the surrounding space. Prior to work taking place, the area around the equipment is to be surveyed to make sure that there are no flammable hazards or ignition risks. "No Smoking" signs shall be displayed.
  - ⑦ Ventilated Area
 

Ensure that the area is in the open or that it is adequately ventilated before breaking into the system or conducting any hot work. A degree of ventilation shall continue during the period that the work is carried out. The ventilation should safely disperse any released refrigerant and preferably expel it externally into the atmosphere.
  - ⑧ Checks on the Refrigeration Equipment
 

Where electrical components are being changed, they shall be fit for the purpose and to the correct specification. At all times the manufacturer's maintenance and service guidelines shall be followed. If in doubt, consult the manufacturer's technical department for assistance.

The following checks shall be applied to installations using flammable refrigerants:

    - The charge size is in accordance with the room size within which the refrigerant containing parts are installed.
    - The ventilation machinery and outlets are operating adequately and are not obstructed.
    - If an indirect refrigerating circuit is being used, the secondary circuit shall be checked for the presence of refrigerant.
    - Marking to the equipment continues to be visible and legible. Markings and signs that are illegible shall be corrected.
    - Refrigeration pipe or components are installed in a position where they are unlikely to be exposed to any substance which may corrode refrigerant containing components, unless the components are constructed of materials which are inherently resistant to being corroded or are suitably protected against being corroded.
  - ⑨ Checks on Electrical Devices
 

Repair and maintenance to electrical components shall include initial safety checks and component inspection procedures. If a fault exists that could compromise safety, then no electrical supply shall be connected to the circuit until it is satisfactorily dealt with. If the fault cannot be corrected immediately but it is necessary to continue operation, an adequate temporary solution shall be used. This shall be reported to the owner of the equipment so all parties are advised.

Initial safety checks shall include that:

    - capacitors are discharged: this shall be done in a safe manner to avoid possibility of sparking;
    - no live electrical components and wiring are exposed while charging, recovering or purging the system;
    - there is continuity of earth bonding
2. Repairs to Sealed Components
  - ① During repairs to sealed components, all electrical supplies shall be disconnected from the equipment being worked upon prior to any removal of sealed covers, etc. If it is absolutely necessary to have an electrical supply to equipment during servicing, then a permanently operating form of leak detection shall be located at the most critical point to warn of a potentially hazardous situation.
  - ② Particular attention shall be paid to the following to ensure that by working on electrical components, the casing is not altered in such a way that the level of protection is affected. This shall include damage to cables, excessive number of connections, terminals not made to original specification, damage to seals, incorrect fitting of glands, etc.
 

Ensure that the apparatus is mounted securely.

Ensure that seals or sealing materials have not degraded to the point that they no longer serve the purpose of preventing the ingress of flammable atmospheres. Replacement parts shall be in accordance with the manufacturer's specifications.
3. Repair to Intrinsic Safe Components
 

Do not apply any permanent inductive or capacitance loads to the circuit without ensuring that this will not exceed the permissible voltage and current permitted for the equipment in use.

Intrinsic safe components are the only types that can be worked on while live in the presence of a flammable atmosphere. The test apparatus shall be at the correct rating.

Replace components only with parts specified by the manufacturer. Other parts may result in the ignition of refrigerant in the atmosphere from a leak.
4. Cabling
 

Check that cabling will not be subject to wear, corrosion, excessive pressure, vibration, sharp edges or any other adverse environmental effects. The check shall also take into account the effects of aging or continual vibration from sources such as compressors or fans.

5. **Detection of Flammable Refrigerants**  
Under no circumstances shall potential sources of ignition be used in the searching for or detection of refrigerant leaks. A halide torch (or any other detector using a naked flame) shall not be used.
6. **Leak Detection Methods**  
Electronic leak detectors may be used to detect refrigerant leaks but, in the case of flammable refrigerants, the sensitivity may not be adequate, or may need re-calibration. (Detection equipment shall be calibrated in a refrigerant-free area.) Ensure that the detector is not a potential source of ignition and is suitable for the refrigerant used. Leak detection equipment shall be set at a percentage of the LFL of the refrigerant and shall be calibrated to the refrigerant employed, and the appropriate percentage of gas (25 % maximum) is confirmed.  
Leak detection fluids are suitable for use with most refrigerants but the use of detergents containing chlorine shall be avoided as the chlorine may react with the refrigerant and corrode the copper pipe-work.  
If a leak is suspected, all naked flames shall be removed/extinguished.  
If a leakage of refrigerant is found which requires brazing, all of the refrigerant shall be recovered from the system, or isolated (by means of shut off valves) in a part of the system remote from the leak. For appliances containing flammable refrigerants, oxygen free nitrogen (OFN) shall then be purged through the system both before and during the brazing process.
7. **Removal and Evacuation**  
When breaking into the refrigerant circuit to make repairs - or for any other purpose conventional procedures shall be used. However, for flammable refrigerants it is important that best practice is followed since flammability is a consideration. The following procedure shall be adhered to:
- remove refrigerant
  - purge the circuit with inert gas
  - evacuate
  - purge again with inert gas
  - open the circuit by cutting or brazing.
- The refrigerant charge shall be recovered into the correct recovery cylinders. For appliances containing flammable refrigerants, the system shall be "flushed" with OFN to render the unit safe. This process may need to be repeated several times. Compressed air or oxygen shall not be used for purging refrigerant systems.  
For appliances containing flammable refrigerants, flushing shall be achieved by breaking the vacuum in the system with OFN and continuing to fill until the working pressure is achieved, then venting to atmosphere, and finally pulling down to a vacuum. This process shall be repeated until no refrigerant is within the system. When the final OFN charge is used, the system shall be vented down to atmospheric pressure to enable work to take place. This operation is absolutely vital if brazing operations on the pipe-work are to take place.  
Ensure that the outlet for the vacuum pump is not close to any ignition sources and that ventilation is available.
8. **Charging Procedures**  
In addition to conventional charging procedures, the following requirements shall be followed:
- Ensure that contamination of different refrigerants does not occur when using charging equipment. Hoses or lines shall be as short as possible to minimize the amount of refrigerant contained in them.
  - Cylinders shall be kept upright.
  - Ensure that the refrigeration system is earthed prior to charging the system with refrigerant.
  - Label the system when charging is complete (if not already).
  - Extreme care shall be taken not to overfill the refrigeration system.
- Prior to recharging the system, it shall be pressure-tested with the appropriate purging gas. The system shall be leak-tested on completion of charging but prior to commissioning. A follow up leak test shall be carried out prior to leaving the site.
9. **Decommissioning**  
Before carrying out this procedure, it is essential that the technician is completely familiar with the equipment and all its detail. It is recommended good practice that all refrigerants are recovered safely. Prior to the task being carried out, an oil and refrigerant sample shall be taken in case analysis is required prior to re-use of reclaimed refrigerant. It is essential that electrical power is available before the task is commenced.
- a) Become familiar with the equipment and its operation.
  - b) Isolate system electrically.
  - c) Before attempting the procedure, ensure that:
    - mechanical handling equipment is available, if required, for handling refrigerant cylinders;
    - all personal protective equipment is available and being used correctly;
    - the recovery process is supervised at all times by a competent person;
    - recovery equipment and cylinders conform to the appropriate standards.
  - d) Pump down refrigerant system, if possible.
  - e) If a vacuum is not possible, make a manifold so that refrigerant can be removed from various parts of the system.
  - f) Make sure that cylinder is situated on the scales before recovery takes place.
  - g) Start the recovery machine and operate in accordance with manufacturer's instructions.
  - h) Do not overfill cylinders. (no more than 80 % volume liquid charge).
  - i) Do not exceed the maximum working pressure of the cylinder, even temporarily.
  - j) When the cylinders have been filled correctly and the process completed, make sure that the cylinders and the equipment are removed from site promptly and all isolation valves on the equipment are closed off.
  - k) Recovered refrigerant shall not be charged into another refrigeration system unless it has been cleaned and checked.
10. **Labeling**  
Equipment shall be labeled stating that it has been de-commissioned and emptied of refrigerant. The label shall be dated and signed. For appliances containing flammable refrigerants, ensure that there are labels on the equipment stating the equipment contains flammable refrigerant.
11. **Recovery**  
When removing refrigerant from a system, either for servicing or decommissioning, it is recommended good practice that all refrigerants are removed safely. When transferring refrigerant into cylinders, ensure that only appropriate refrigerant recovery cylinders are employed. Ensure that the correct number of cylinders for holding the total system charge are available. All cylinders to be used are designated for the recovered refrigerant and labeled for that refrigerant (i.e. special cylinders for the recovery of refrigerant). Cylinders shall be complete with pressure-relief valve and associated shut-off valves in good working order. Empty recovery cylinders are evacuated and, if possible, cooled before recovery occurs.  
The recovery equipment shall be in good working order with a set of instructions concerning the equipment that is at hand and shall be suitable for the recovery of all appropriate refrigerants including, when applicable, flammable refrigerants. In addition, a set of calibrated weighing scales shall be available and in good working order. Hoses shall be complete with leak-free disconnect couplings and in good condition. Before using the recovery machine, check that it is in satisfactory working order, has been properly maintained and that any associated electrical components are sealed to prevent ignition in the event of a refrigerant release. Consult manufacturer if in doubt.  
The recovered refrigerant shall be returned to the refrigerant supplier in the correct recovery cylinder, and the relevant waste transfer note arranged. Do not mix refrigerants in recovery units and especially not in cylinders.  
If compressors or compressor oils are to be removed, ensure that they have been evacuated to an acceptable level to make certain that flammable refrigerant does not remain within the lubricant. The evacuation process shall be carried out prior to returning the compressor to the suppliers. Only electric heating to the compressor body shall be employed to accelerate this process. When oil is drained from a system, it shall be carried out safely.

# 3

# PART NAMES AND FUNCTIONS

**MUZ-HR25VF**

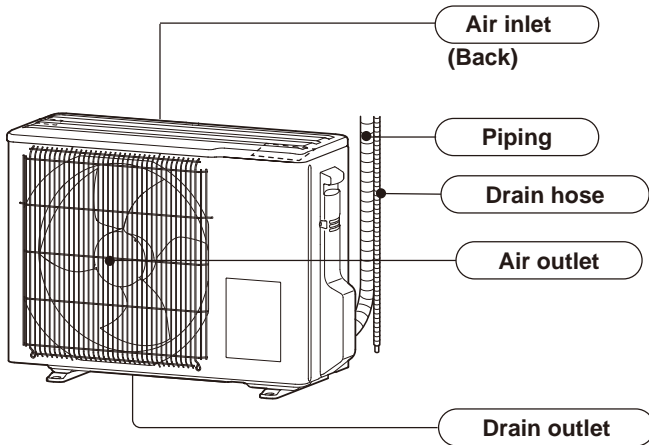

**MUZ-HR35VF**

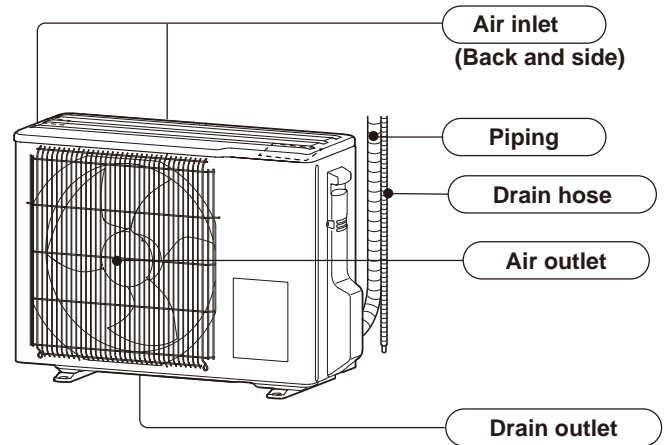

**MUZ-HR42VF  
MUZ-HR50VF**

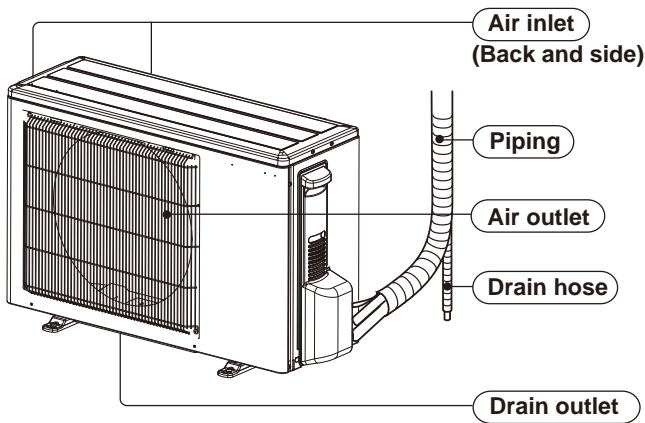

**MUZ-HR60VF  
MUZ-HR71VF**

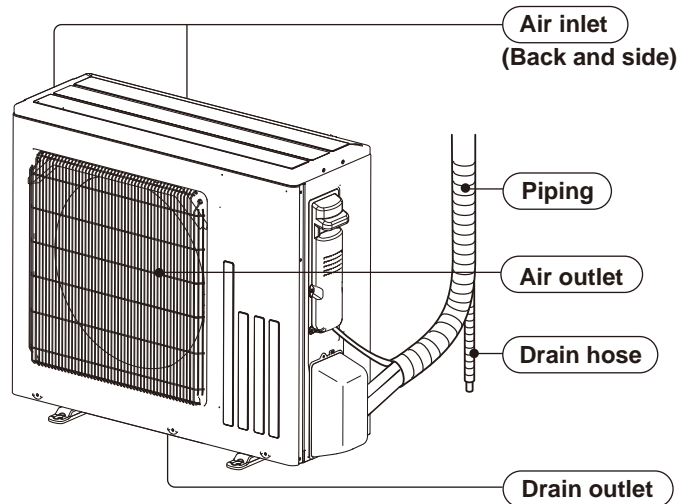

## ACCESSORIES

<b>MODELS</b>	<b>MUZ-HR25VF</b> <b>MUZ-HR35VF</b> <b>MUZ-HR42VF</b> <b>MUZ-HR50VF</b> <b>MUZ-HR60VF</b> <b>MUZ-HR71VF</b>
Drain socket	1

## 4

## SPECIFICATION

Outdoor model			MUZ-HR25VF	MUZ-HR35VF	MUZ-HR42VF	MUZ-HR50VF	MUZ-HR60VF	MUZ-HR71VF			
Power supply			Single phase, 230 V, 50 Hz								
Capacity Rated (Min.-Max.)	Cooling	kW	2.5(0.5-2.9)	3.4(0.9-3.4)	4.2 (1.1-4.5)	5.0 (1.3-5.0)	6.1 (1.7-7.4)	7.1 (1.8-7.4)			
	Heating		3.15(0.5-3.5)	3.6(0.9-3.7)	4.7(0.9-5.4)	5.4 (1.4-6.5)	6.8 (1.5-9.0)	8.1 (1.5-9.0)			
Breaker Capacity		A	10	10	10	12	16	16			
Electrical data	Power input *1 (Set)	Cooling	800	1,210	1,340	2,050	1,810	2,330			
		Heating	850	975	1,300	1,550	1,810	2,440			
	Running current *1 (Set)	Cooling	A	3.8	5.9	5.9	9.0	8.0	10.3		
		Heating		4.1	4.6	5.8	6.9	8.0	10.8		
	Power factor *1 (Set)	Cooling	%	91	89	98	99	98	98		
		Heating		90	92	97	97	98	98		
Starting current *1 (Set)		A	4.1	5.9	5.9	9.0	8.0	10.8			
Coefficient of performance (COP) *1 (Set)		Cooling	3.13	2.81	3.13	2.44	3.37	3.05			
		Heating	3.71	3.69	3.62	3.48	3.76	3.32			
Compressor			Model		KVB059FTMMC	KVB073FUJMC	KVB092FYAMC	SVB130FBBMC	SVB130FBBMT	SVB130FBBMT	
			Output		W	490	550	650	900	900	900
			Current *1	Cooling	A	3.37	5.40	5.14	8.51	7.70	10.00
				Heating		3.67	4.15	5.27	6.31	7.70	10.50
Refrigeration oil (Model)			L	0.27 (FW68S)	0.27 (FW68S)	0.27 (FW68S)	0.35 (FW68S)	0.35 (FW68S)	0.35 (FW68S)		
Fan motor			Model		RC0J55-DC	RC0J55-DC	RC0J55-DC	RC0J55-DC	RC0J50-RA	RC0J50-RA	
			Current *1	Cooling	A	0.24	0.23	0.20	0.20	0.30	0.30
Heating	0.24	0.23		0.23		0.23	0.30	0.30			
Dimensions W x H x D			mm	699 x 538 x 249			800 x 550 x 285		800 x 714 x 285		
Weight			kg	23	24	34	35	40	40		
Special remarks	Dehumidification		Cooling	L/h	0.8	1.1	1.6	2.0	1.7	2.6	
	Airflow *1	Cooling	High	m³/h	1,818	1,932	2,058	2,058	2,898	2,898	
			Low		990	1,050	906	906	1,320	1,320	
		Heating	High		1,932	2,052	1,962	1,962	2,898	2,898	
			Med.		1,680	1,788	1,686	1,686	2,238	2,238	
			Low		1,356	1,452	1,260	1,260	1,704	1,704	
	Sound level *1		Cooling	dB(A)	50	51	50	50	53	53	
			Heating		50	51	51	51	57	57	
	Fan speed		Cooling	High	rpm	840	840	940	940	1,060	1,060
				Low		480	480	460	460	490	490
			Heating	High		890	890	900	900	1,060	1,060
				Med.		780	780	780	780	780	780
				Low		640	640	600	600	610	610
Fan speed regulator				3	3	3	3	3	3		
Refrigerant filling capacity (R32)			kg	0.40	0.45	0.70	0.80	1.05	1.05		

**NOTE:** Test conditions are based on ISO 5151.

Cooling: Indoor Dry-bulb temperature 27°C

Outdoor Dry-bulb temperature 35°C

Heating: Indoor Dry-bulb temperature 20°C

Outdoor Dry-bulb temperature 7°C

Refrigerant piping length (one way): 5 m

Wet-bulb temperature 19°C

Wet-bulb temperature 24°C

Wet-bulb temperature 15°C

Wet-bulb temperature 6°C

\*1 Measured under rated operating frequency.

**Specifications and rated conditions of main electric parts**

Item	Model	MUZ-HR25VF	MUZ-HR35VF	MUZ-HR42VF	MUZ-HR50VF	MUZ-HR60VF	MUZ-HR71VF
		Smoothing capacitor	(C61)	—		600 μF/ 620 μF 420 V	
	(C62)	800 μF 420 V		600 μF/ 620 μF 420 V		600 μF/ 620 μF 420 V	
	(C63)	—		600 μF/ 620 μF 420 V		600 μF/ 620 μF 420 V	
Diode module	(DB61)	15 A 600 V		15 A 600 V	25 A 600 V	25 A 600 V	
Diode module	(DB65)	25 A 600 V		25 A 600 V		25 A 600 V	
Fuse	(F61)	15A 250V		25A 250V		25A 250V	
	(F62)	15A 250V		15A 250V		15A 250V	
	(F701, F801, F901)	T3.15AL250V		T3.15AL250V		T3.15AL250V	
Power module	(IC700)	10 A 600 V		20 A 600 V		20 A 600 V	
	(IC932)	5 A 600 V		5 A 600 V		5 A 600 V	
Expansion valve coil	(LEV)	12 V DC		12 V DC		12 V DC	
Reactor	(L61)	18 mH	23 mH	23 mH		23 mH	
Switch power transistor	(Q821)	30/37 A 600 V		30/37 A 600 V		30 A/37 A 600 V	
Current-limiting PTC thermistor	(PTC64)	—		33 Ω		33 Ω	
	(PTC65)	33 Ω		33 Ω		33 Ω	
Terminal block	(TB1)	5 P		5 P		5 P	
Relay	(X63)	3 A 250 V		3 A 250 V		3 A 250 V	
	(X64)	20 A 250 V		20 A 250 V		20 A 250 V	
	(X69)	—		—		—	
R.V.coil	(21S4)	220 - 240 V AC		220 - 240 V AC		220 - 240 V AC	

## 5 NOISE CRITERIA CURVES

### MUZ-HR25VF

FUNCTION	SPL(dB(A))	LINE
COOLING	50	●—●
HEATING	50	○—○

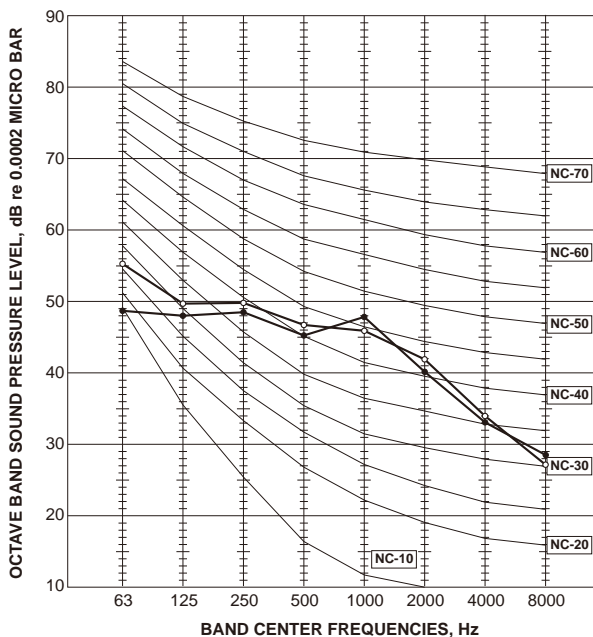

### MUZ-HR35VF

FUNCTION	SPL(dB(A))	LINE
COOLING	51	●—●
HEATING	51	○—○

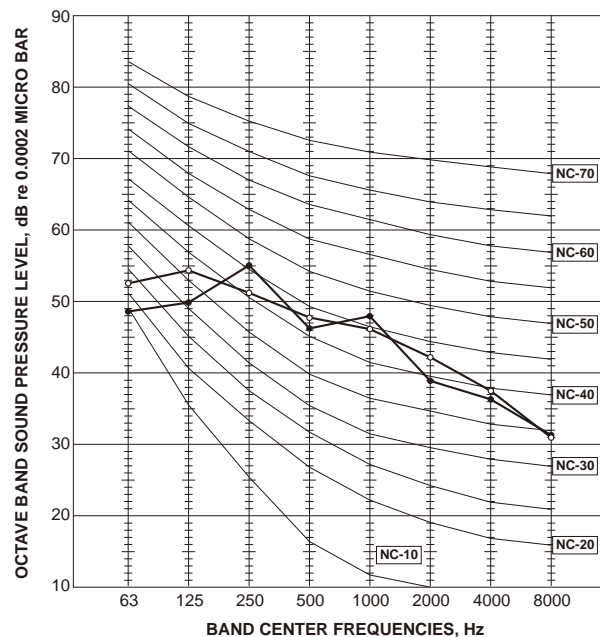

### MUZ-HR42VF

FUNCTION	SPL(dB(A))	LINE
COOLING	50	●—●
HEATING	51	○—○

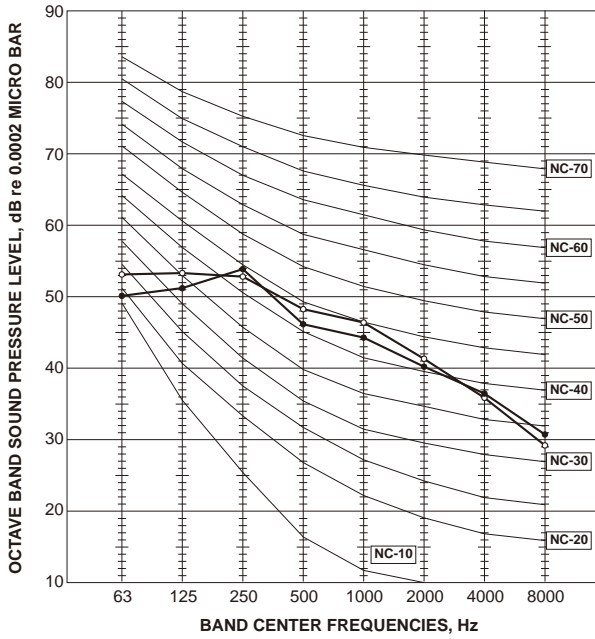

### MUZ-HR50VF

FUNCTION	SPL(dB(A))	LINE
COOLING	50	●—●
HEATING	51	○—○

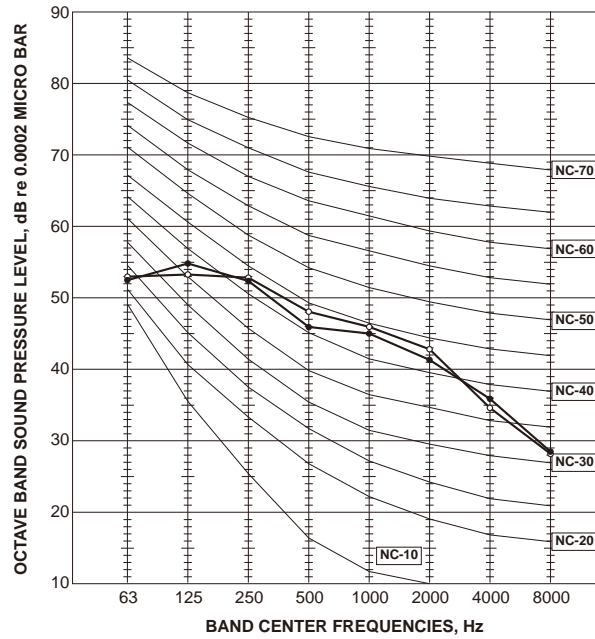

### MUZ-HR60VF

FUNCTION	SPL(dB(A))	LINE
COOLING	53	●—●
HEATING	57	○—○

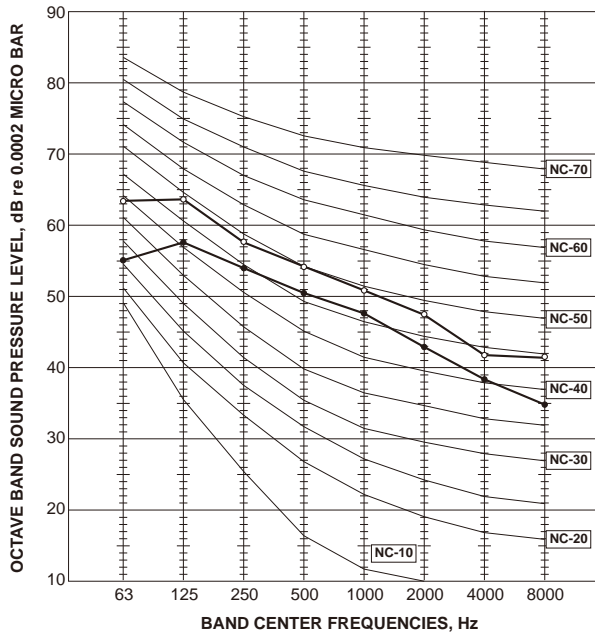

### MUZ-HR71VF

FUNCTION	SPL(dB(A))	LINE
COOLING	53	●—●
HEATING	57	○—○

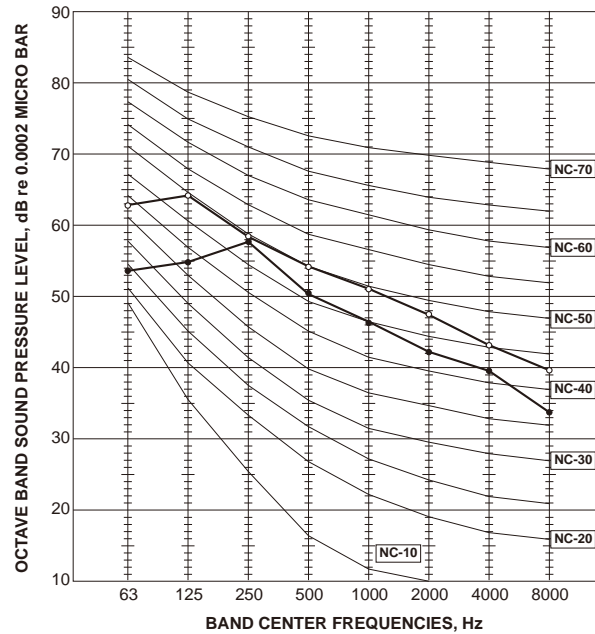

#### Test conditions

Cooling: Dry-bulb temperature 35°C Wet-bulb temperature 24°C  
 Heating: Dry-bulb temperature 7°C Wet-bulb temperature 6°C

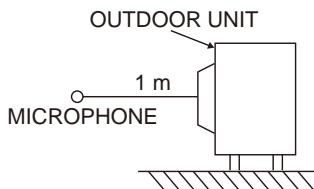



# 6

# OUTLINES AND DIMENSIONS

## MUZ-HR25VF MUZ-HR35VF

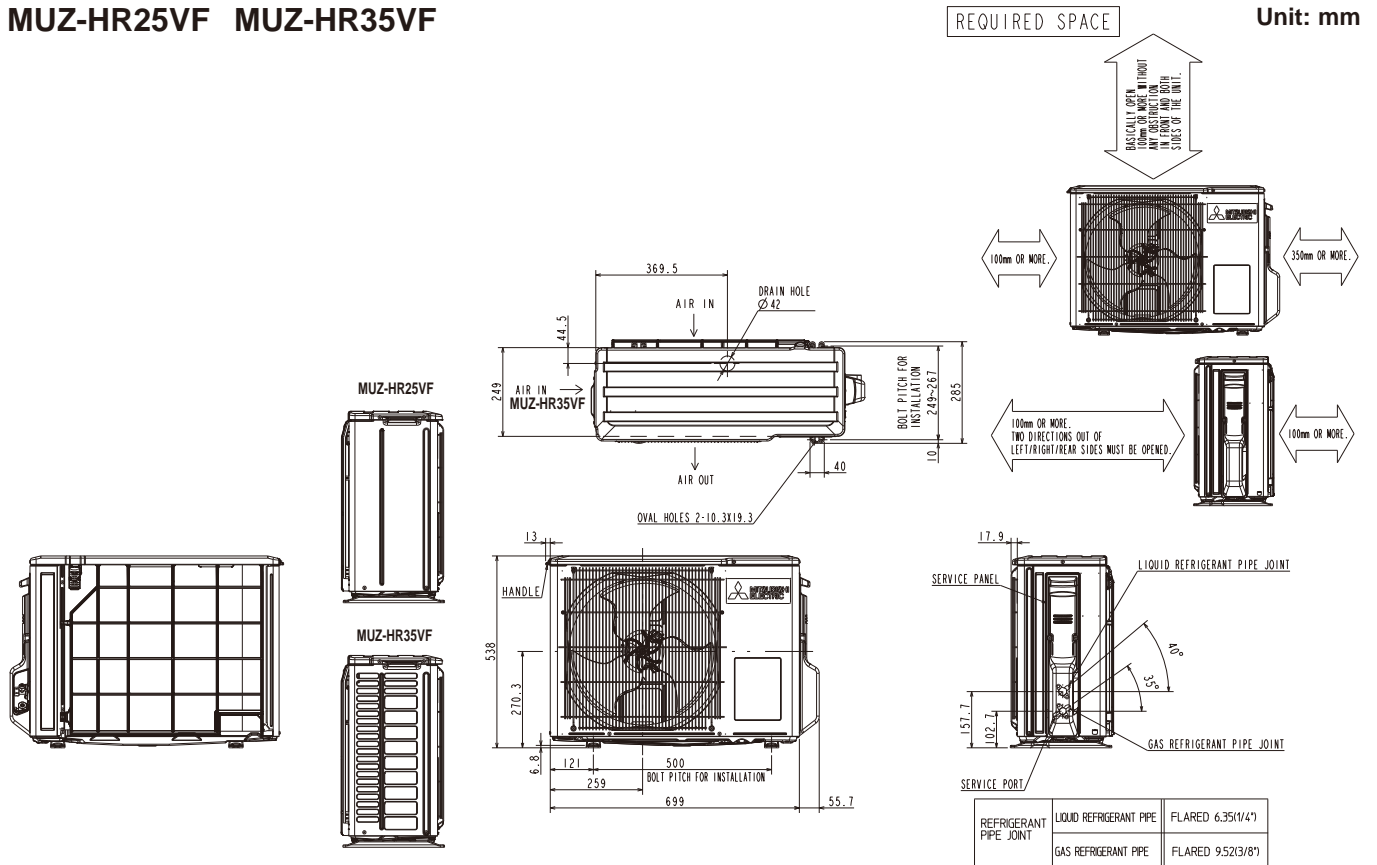

## MUZ-HR42VF MUZ-HR50VF

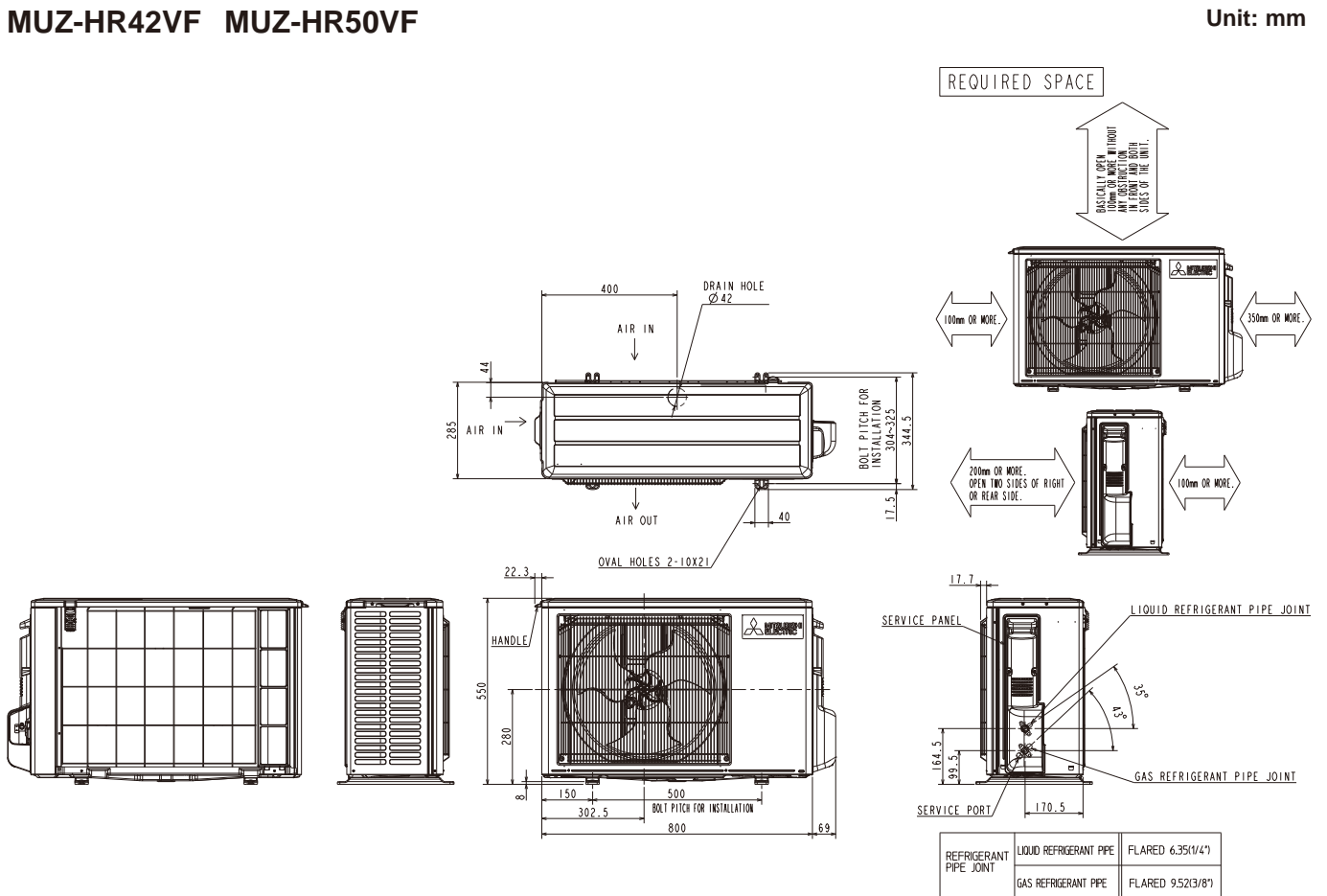

MUZ-HR60VF MUZ-HR71VF

Unit: mm

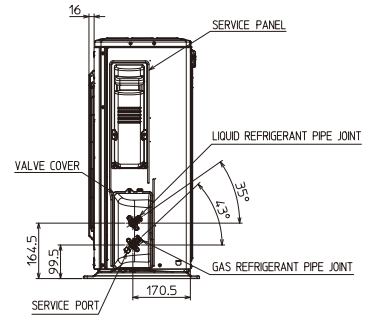
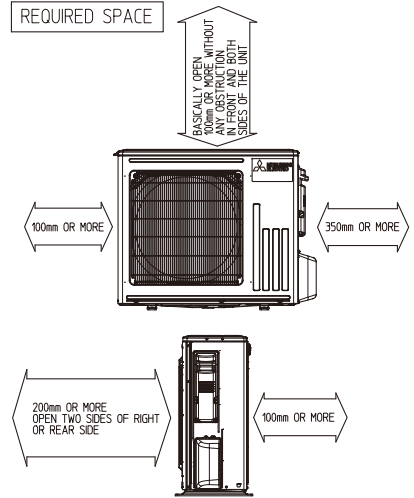
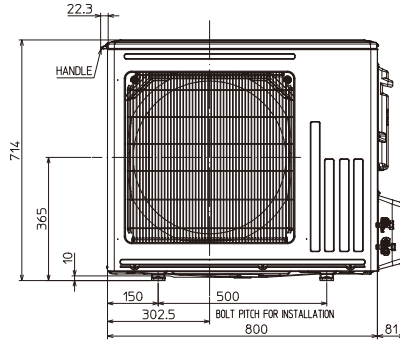
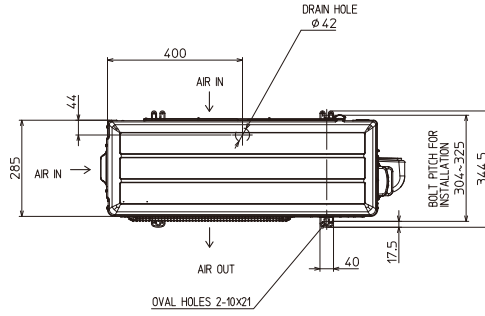
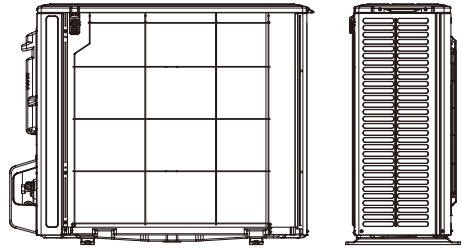

MUZ-HR60/71VF

REFRIGERANT PIPE JOINT	LIQUID REFRIGERANT PIPE	FLARED 6.35(1/4")
	GAS REFRIGERANT PIPE	FLARED 12.7(1/2")

## MUZ-HR25VF -[E1], [ER1] MUZ-HR35VF -[E1], [ER1]

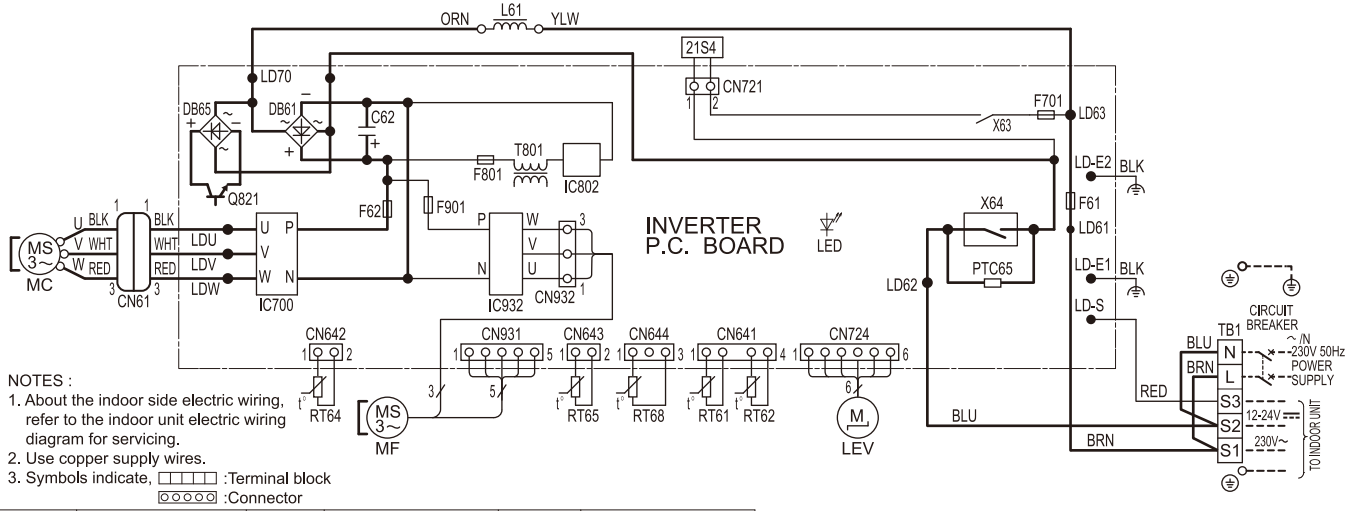

SYMBOL	NAME	SYMBOL	NAME	SYMBOL	NAME
CN61	CONNECTOR	LEV	EXPANSION VALVE COIL	RT64	FIN TEMP. THERMISTOR
C62	SMOOTHING CAPACITOR	L61	REACTOR	RT65	AMBIENT TEMP. THERMISTOR
DB61, DB65	DIODE MODULE	MC	COMPRESSOR	RT68	OUTDOOR HEAT EXCHANGER TEMP. THERMISTOR
F61, F62	FUSE (15A 250V)	MF	FAN MOTOR		
F701, F801, F901	FUSE (T3, 15AL250V)	PTC65	CIRCUIT PROTECTION	TB1	TERMINAL BLOCK
IC700, IC932	POWER MODULE	Q821	SWITCHING POWER TRANSISTOR	T801	TRANSFORMER
IC802	POWER DEVICE	RT61	DEFROST THERMISTOR	X63, X64	RELAY
LED	LED DEVICE	RT62	DISCHARGE TEMP. THERMISTOR	21S4	REVERSING VALVE COIL

## MUZ-HR25VF -[ET1] MUZ-HR35VF -[ET1]

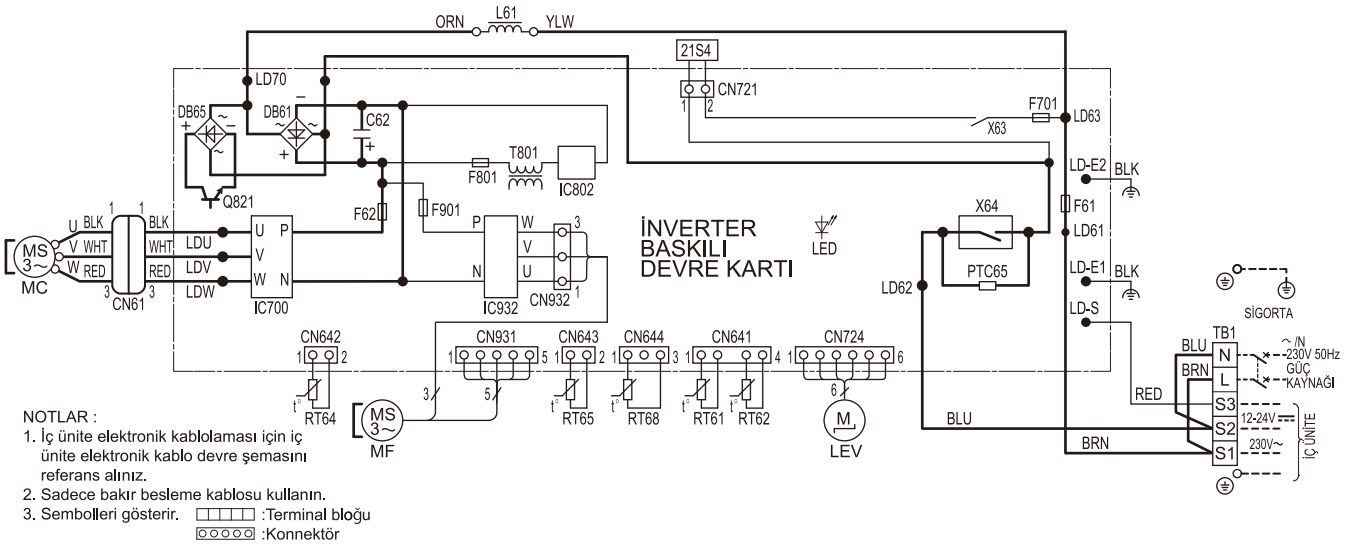

SEMBOL	PARÇA ADI	SEMBOL	PARÇA ADI	SEMBOL	PARÇA ADI
CN61	KONNEKTÖR	LEV	GENLEŞME VANASI SARGISI	RT64	FIN SICAKLIK TERMİSTÖRÜ
C62	KAPASİTÖR	L61	REAKTÖR	RT65	ORTAM SICAKLIK TERMİSTÖRÜ
DB61, DB65	DİYOT MODÜLÜ	MC	KOMPRESÖR	RT68	DIŞ ÜNİTE EŞANJÖR SICAKLIK TERMİSTÖRÜ
F61, F62	SİGORTA (15A 250V)	MF	FAN MOTORU		
F701, F801, F901	SİGORTA (T3, 15AL250V)	PTC65	DEVRE KORUMASI	TB1	TERMINAL BLOĞU
IC700, IC932	GÜÇ MODÜLÜ	Q821	SIVILCI GÜÇ TRANSİSTÖRÜ	T801	TRANSFORMATÖR
IC802	GÜÇ CHAZI	RT61	DEFROST TERMİSTÖRÜ	X63, X64	RÖLE
LED	LED	RT62	BASMA SICAKLIK TERMİSTÖRÜ	21S4	4 YOLLU VANA SARGISI

## MUZ-HR42VF -[E1], [ER1] MUZ-HR50VF -[E1], [ER1]

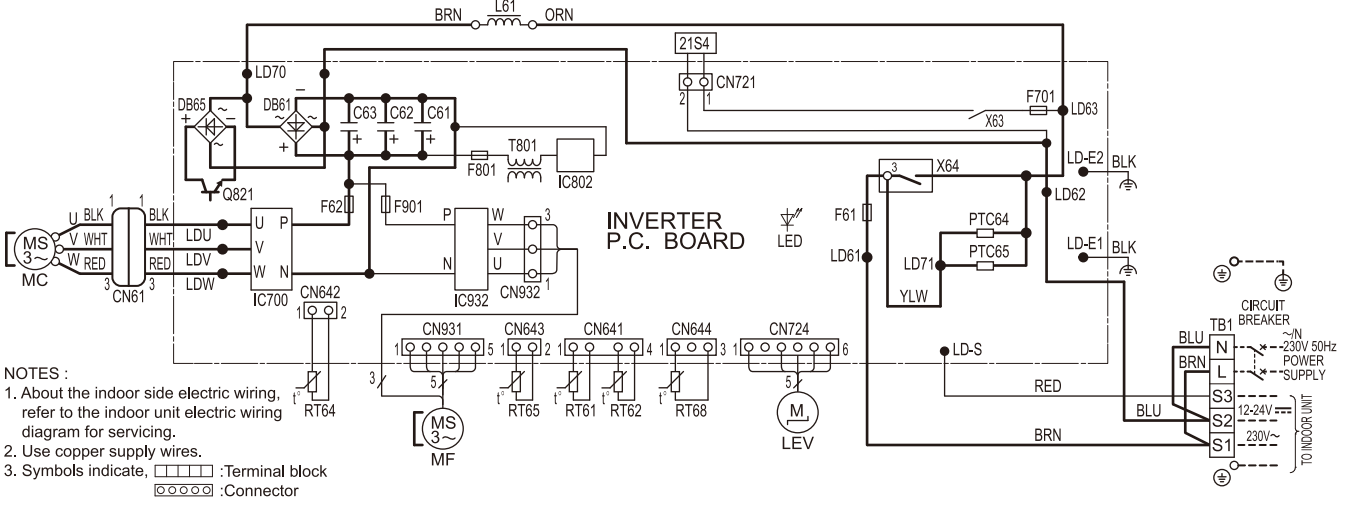

SYMBOL	NAME	SYMBOL	NAME	SYMBOL	NAME
CN61	CONNECTOR	LEV	EXPANSION VALVE COIL	RT65	AMBIENT TEMP. THERMISTOR
C61,C62,C63	SMOOTHING CAPACITOR	L61	REACTOR	RT68	OUTDOOR HEAT EXCHANGER TEMP. THERMISTOR
DB61,DB65	DIODE MODULE	MC	KOMPRESÖR	TB1	TERMINAL BLOCK
F61	FUSE (25A 250V)	MF	FAN MOTOR	T801	TRANSFORMER
F62	FUSE (15A 250V)	PTC64,PTC65	CIRCUIT PROTECTION	X63,X64	RELAY
F701,F801,F901	FUSE (T3. 15AL250V)	Q821	SWITCHING POWER TRANSISTOR	21S4	REVERSING VALVE COIL
IC700,IC932	POWER MODULE	RT61	DEFROST THERMISTOR		
IC802	POWER DEVICE	RT62	DISCHARGE TEMP. THERMISTOR		
LED	LED	RT64	FIN TEMP. THERMISTOR		

## MUZ-HR42VF -[ET1] MUZ-HR50VF -[ET1]

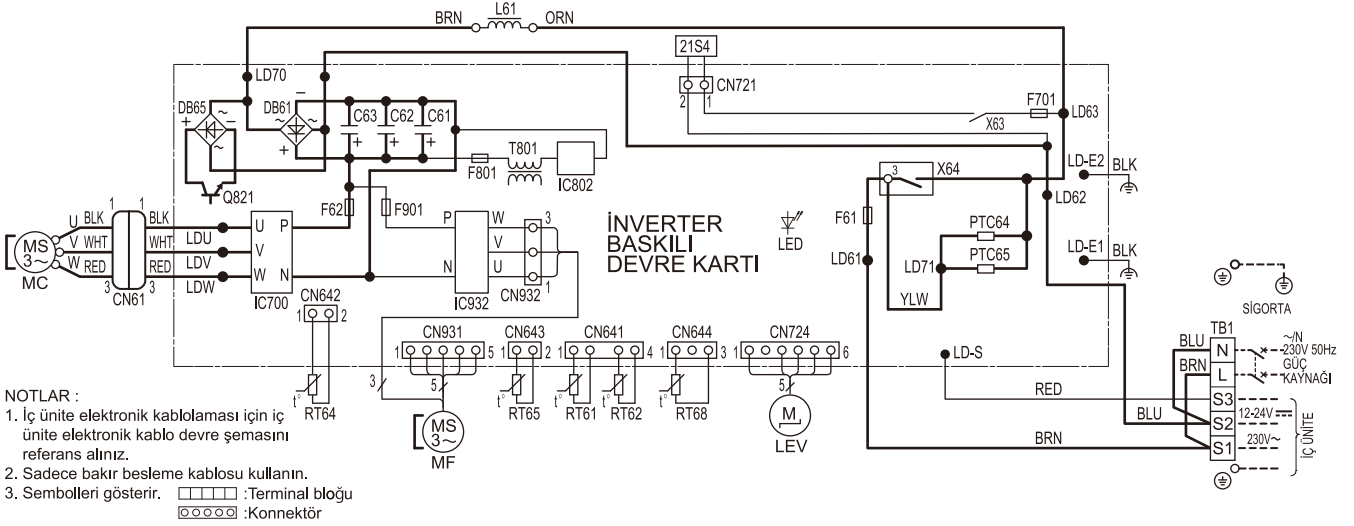

SEMBOL	PARÇA ADI	SEMBOL	PARÇA ADI	SEMBOL	PARÇA ADI
CN61	KONNEKTÖR	LEV	GENLEŞME VANASI SARGISI	RT65	ORTAM SICAKLIK TERMİSTÖRÜ
C61,C62,C63	KAPASİTÖR	L61	REAKTÖR	RT68	DIŞ ÜNİTE EŞANJÖR SICAKLIK TERMİSTÖRÜ
DB61,DB65	DIYOT MODÜLÜ	MC	KOMPRESÖR	TB1	TERMINAL BLOĞU
F61	SIGORTA (25A 250V)	MF	FAN MOTORU	T801	TRANSFORMATÖR
F62	SIGORTA (15A 250V)	PTC64,PTC65	DEVRE KORUMASI	X63,X64	RÖLE
F701,F801,F901	SIGORTA (T3. 15AL250V)	Q821	SIVİÇLİ GÜÇ TRANSİSTÖRÜ	21S4	4 YOLLU VANA SARGISI
IC700,IC932	GÜÇ MODÜLÜ	RT61	DEFROST TERMİSTÖRÜ		
IC802	GÜÇ CİHAZI	RT62	BASMA SICAKLIK TERMİSTÖRÜ		
LED	LED	RT64	FIN SICAKLIK TERMİSTÖRÜ		

## MUZ-HR60VF -[E1, ER1] MUZ-HR71VF -[E1, ER1]

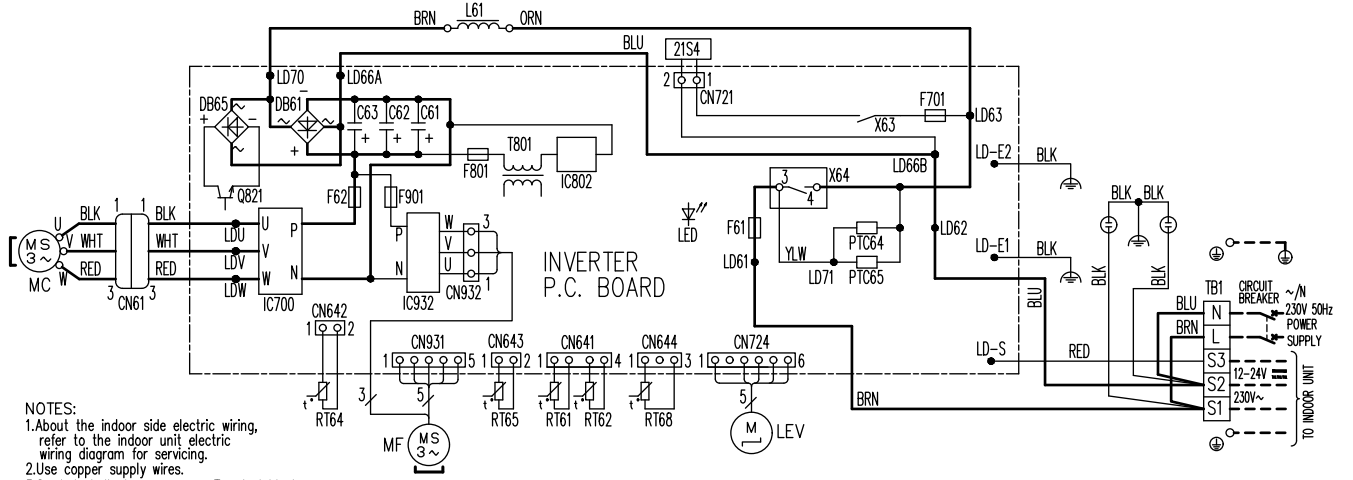

SYMBOL	NAME	SYMBOL	NAME	SYMBOL	NAME
CN61	CONNECTOR	LEV	EXPANSION VALVE COIL	RT65	AMBIENT TEMP. THERMISTOR
C61,C62,C63	SMOOTHING CAPACITOR	L61	REACTOR	RT68	OUTDOOR HEAT EXCHANGER TEMP. THERMISTOR
DB61,DB65	DIODE MODULE	MC	COMPRESSOR		
F61	FUSE (25A 250V)	MF	FAN MOTOR	TB1	TERMINAL BLOCK
F62	FUSE (15A 250V)	PTC64,PTC65	CIRCUIT PROTECTION	T801	TRANSFORMER
F701,F801,F901	FUSE (T3.15A1250V)	Q821	SWITCHING POWER TRANSISTOR	X63,X64	RELAY
IC700,IC932	POWER MODULE	RT61	DEFROST THERMISTOR	21S4	REVERSING VALVE COIL
IC802	POWER DEVICE	RT62	DISCHARGE TEMP. THERMISTOR		
LED	LED	RT64	FIN TEMP. THERMISTOR		

## MUZ-HR60VF -[E1] MUZ-HR71VF -[E1]

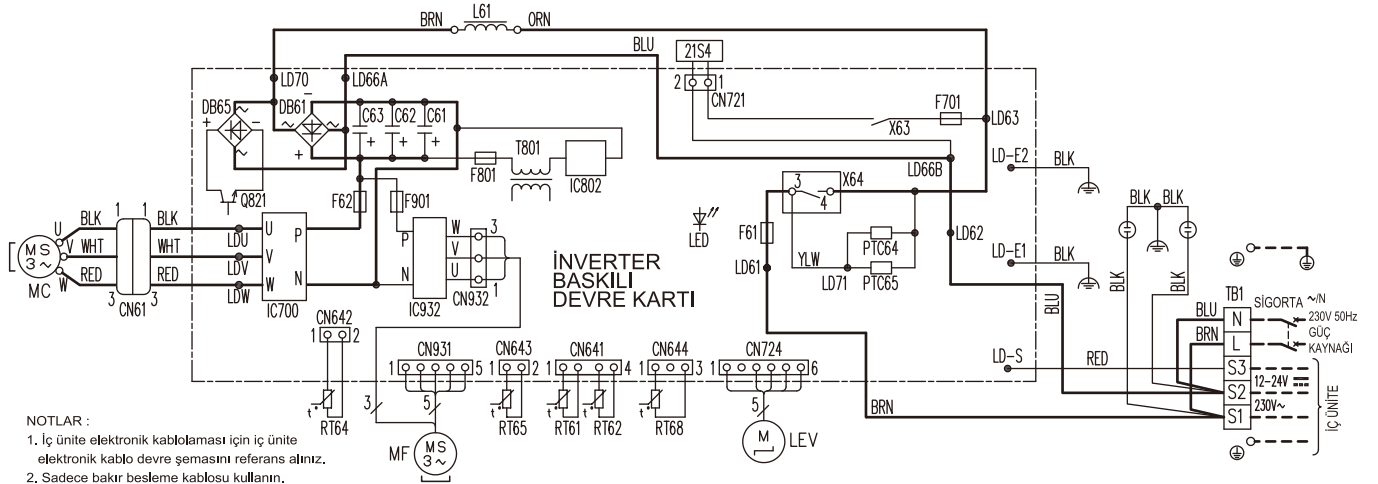

SEMBOL	PARÇA ADI	SEMBOL	PARÇA ADI	SEMBOL	PARÇA ADI
CN61	KONNEKTÖR	LEV	GENLEŞME VANASI SARGISI	RT65	ORTAM SICAKLIK TERMİSTÖRÜ
C61,C62,C63	KAPASİTÖR	L61	REAKTÖR	RT68	DIŞ ÜNİTE EŞANJÖR SICAKLIK TERMİSTÖRÜ
DB61,DB65	DIYOT MODÜLÜ	MC	KOMPRESÖR		
F61	SIGORTA (25A 250V)	MF	FAN MOTORU	TB1	TERMINAL BLOĞU
F62	SIGORTA (15A 250V)	PTC64,PTC65	DEVRE KORUMASI	T801	TRANSFORMATÖR
F701,F801,F901	SIGORTA (T3.15A1250V)	Q821	SIVIÇLI GÜÇ TRANSİSTÖRÜ	X63,X64	RÖLE
IC700,IC932	GÜÇ MODÜLÜ	RT61	DEFROST TERMİSTÖRÜ	21S4	4 YOLLU VANA SARGISI
IC802	GÜÇ CİHAZI	RT62	BASMA SICAKLIK TERMİSTÖRÜ		
LED	LED	RT64	FIN SICAKLIK TERMİSTÖRÜ		

MUZ-HR25VF MUZ-HR35VF

Unit: mm

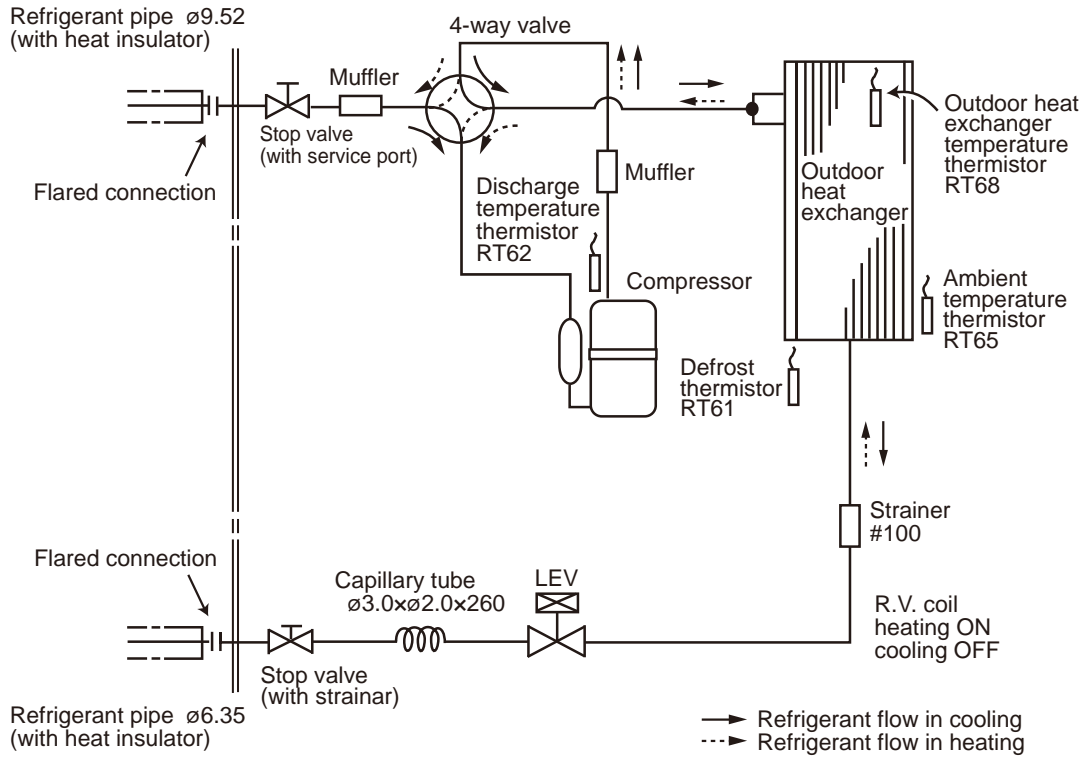

MUZ-HR42VF MUZ-HR50VF

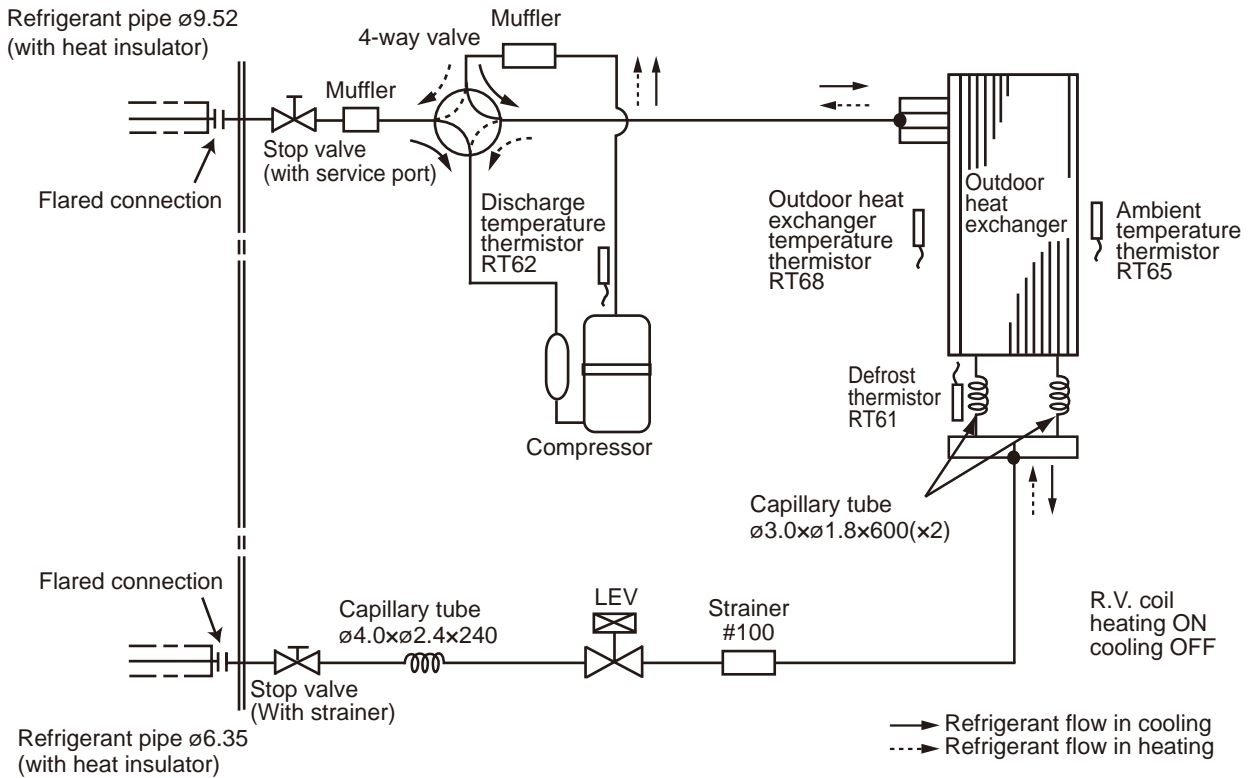

## MUZ-HR60VF MUZ-HR71VF

Refrigerant pipe  $\varnothing 12.7$   
(with heat insulator)

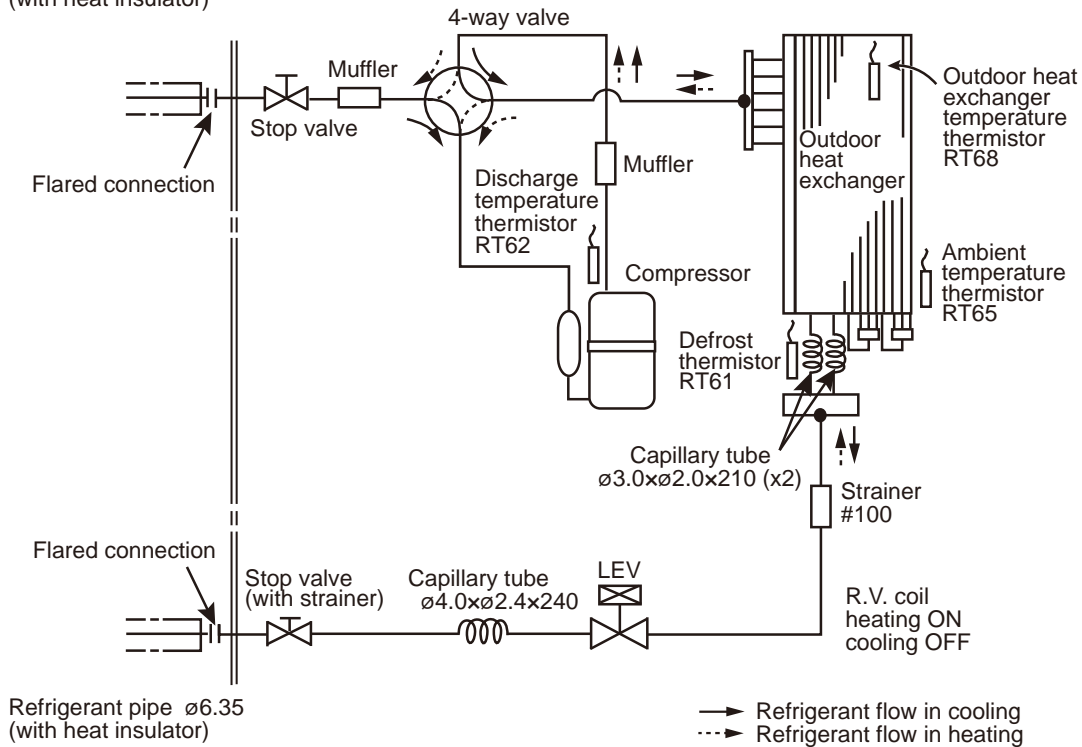

Refrigerant pipe  $\varnothing 6.35$   
(with heat insulator)

→ Refrigerant flow in cooling  
---> Refrigerant flow in heating

## MAX. REFRIGERANT PIPING LENGTH and MAX. HEIGHT DIFFERENCE

Model	Refrigerant piping: m		Piping size O.D: mm	
	Max. Length A	Max. Height difference B	Gas	Liquid
MUZ-HR25/35/42/50VF	20	12	9.52	6.35
MUZ-HR60/71VF	30	15	12.7	6.35

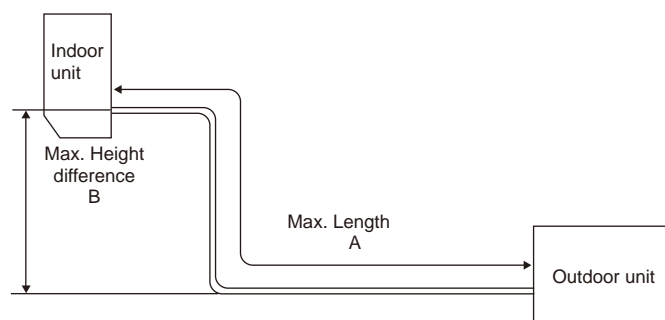

## ADDITIONAL REFRIGERANT CHARGE (R32: g)

Model	Outdoor unit precharged	Refrigerant piping length (one way)										
		7 m	8 m	9 m	10 m	11 m	12 m	13 m	14 m	15 m	20 m	30 m
MUZ-HR25VF	400	0	20	40	60	80	100	120	140	160	260	-
MUZ-HR35VF	450											
MUZ-HR42VF	700											
MUZ-HR50VF	800											
MUZ-HR60/71VF	1,050											

Calculation:  $X \text{ g} = 20 \text{ g/m} \times (\text{Refrigerant piping length (m)} - 7)$

**NOTE:** Refrigerant piping exceeding 7 m requires additional refrigerant charge according to the calculation.

**MUZ-HR25VF MUZ-HR35VF MUZ-HR42VF MUZ-HR50VF MUZ-HR60VF MUZ-HR71VF**

The standard specifications apply only to the operation of the air conditioner under normal conditions. Since operating conditions vary according to the areas where these units are installed, the following information has been provided to clarify the operating characteristics of the air conditioner under the conditions indicated by the performance curve.

**(1) GUARANTEED VOLTAGE**

198-264 V, 50 Hz

**(2) AIRFLOW**

Airflow should be set at MAX.

**(3) MAIN READINGS**

- |  |         |           |
|--|---------|-----------|
| (1) Indoor intake air wet-bulb temperature:  | °C [WB] | } Cooling |
| (2) Indoor outlet air wet-bulb temperature:  | °C [WB] |           |
| (3) Outdoor intake air dry-bulb temperature: | °C [DB] |           |
| (4) Total input:                             | W       |           |
| (5) Indoor intake air dry-bulb temperature:  | °C [DB] | } Heating |
| (6) Outdoor intake air wet-bulb temperature: | °C [WB] |           |
| (7) Total input:                             | W       |           |

Indoor air wet and dry bulb temperature difference on the left side of the following chart shows the difference between the indoor intake air wet and dry bulb temperature and the indoor outlet air wet and dry bulb temperature for your reference at service.

**How to measure the indoor air wet and dry bulb temperature difference**

- Attach at least 2 sets of wet and dry bulb thermometers to the indoor air intake as shown in the figure, and at least 2 sets of wet and dry bulb thermometers to the indoor air outlet. The thermometers must be attached to the position where air speed is high.
- Attach at least 2 sets of wet and dry bulb thermometers to the outdoor air intake.  
Cover the thermometers to prevent direct rays of the sun.
- Check that the air filter is cleaned.
- Open windows and doors of room.
- Press the EMERGENCY OPERATION switch once (twice) to start the EMERGENCY COOL (HEAT) MODE.
- When system stabilizes after more than 15 minutes, measure temperature and take an average temperature.
- 10 minutes later, measure temperature again and check that the temperature does not change.

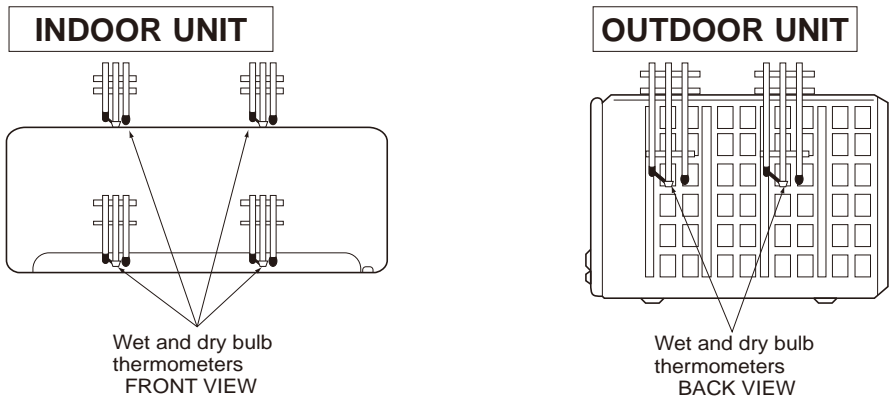

**9-1. CAPACITY AND INPUT CURVES**

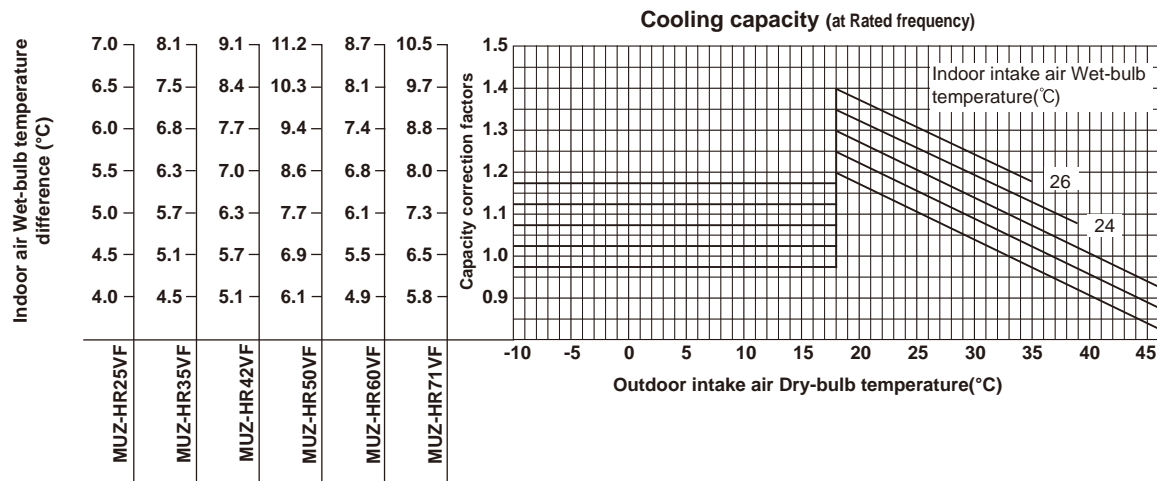





**Total input (Cooling : at Rated frequency)**

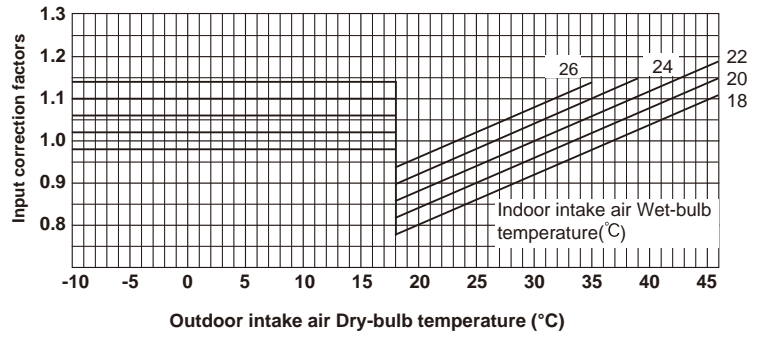

20.4	22.4	22.9	24.4	22.7	27.0
18.8	20.7	21.2	22.5	20.9	24.9
17.3	19.0	19.4	20.6	19.2	22.9
15.7	17.2	17.6	18.7	17.5	20.8
14.1	15.5	15.9	16.9	15.7	18.7
12.6	13.8	14.1	15.0	14.0	16.6
11.0	12.1	12.3	13.1	12.2	14.6
9.4	10.3	10.6	11.2	10.5	12.5
7.8	8.6	8.8	9.4	8.7	10.4
6.3	6.9	7.1	7.5	7.0	8.3
MUZ-HR25VF	MUZ-HR35VF	MUZ-HR42VF	MUZ-HR50VF	MUZ-HR60VF	MUZ-HR71VF

**Heating capacity (at Rated frequency)**

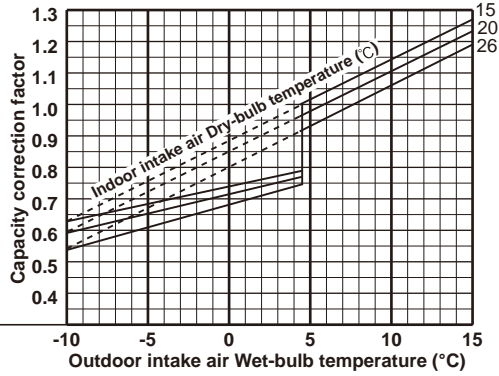

**Total input (Heating : at Rated frequency)**

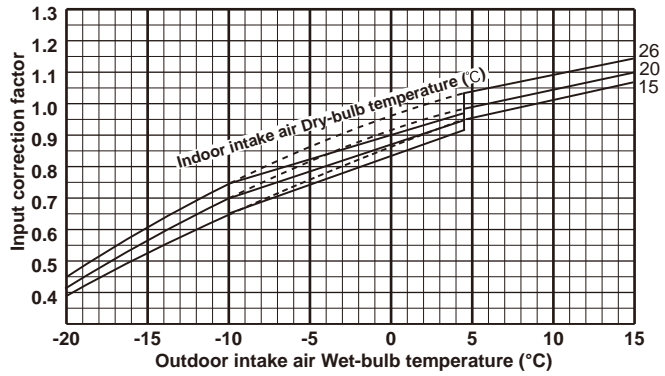

**NOTE:** The above broken lines are for the heating operation without any frost and defrost operation.

## 9-2. CAPACITY AND INPUT CORRECTION BY OPERATIONAL FREQUENCY OF COMPRESSOR

### MUZ-HR25VF

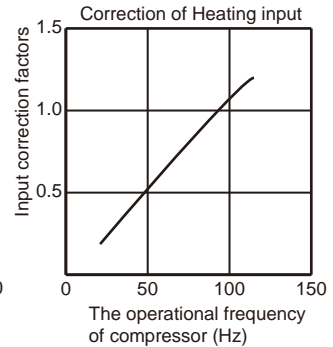
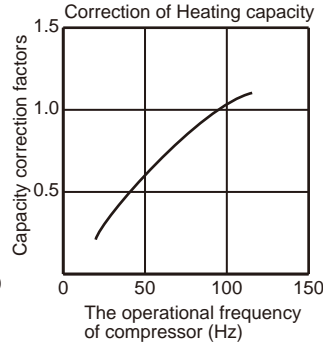
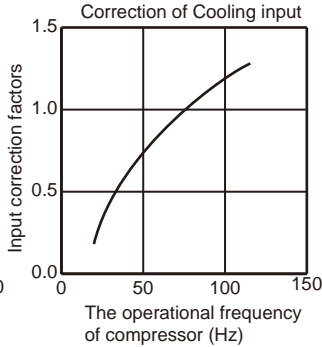
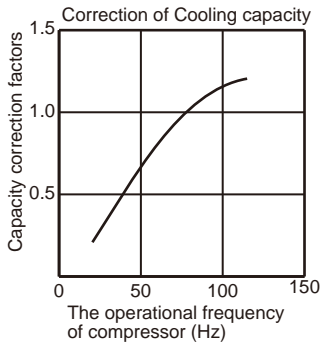

### MUZ-HR35VF

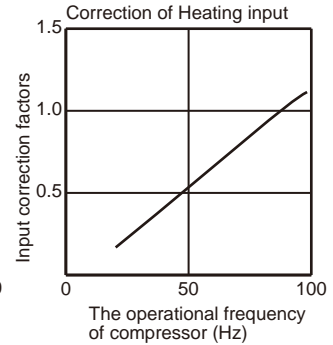
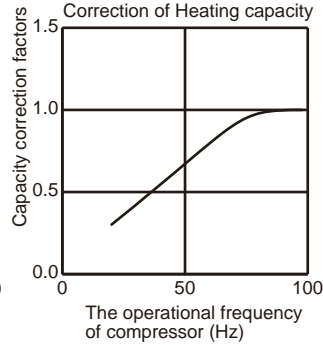
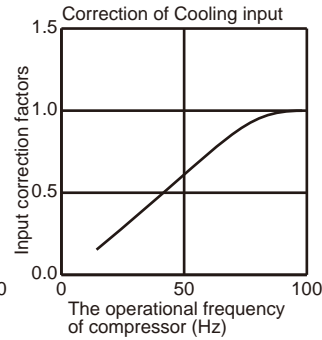
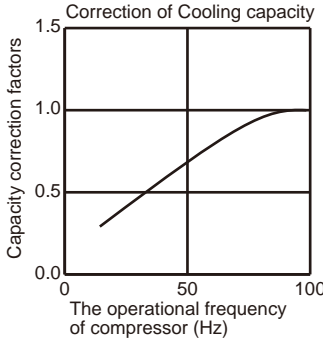

### MUZ-HR42VF

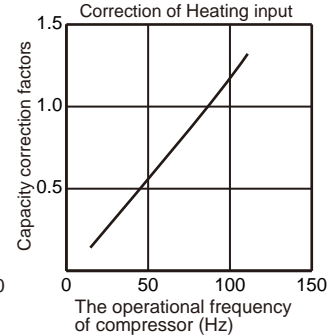
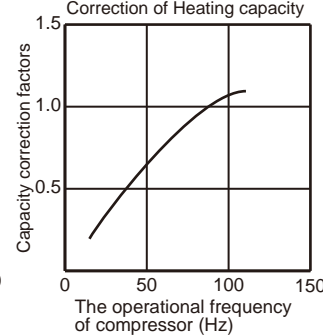
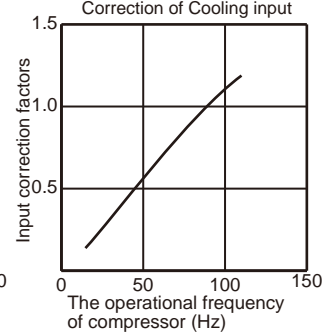
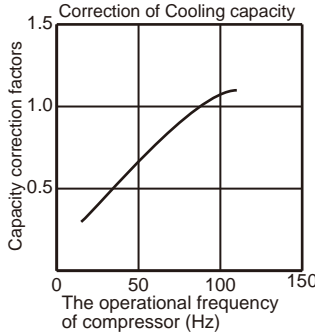

### MUZ-HR50VF

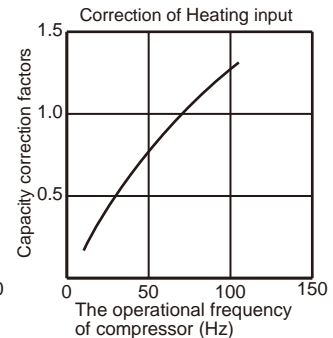
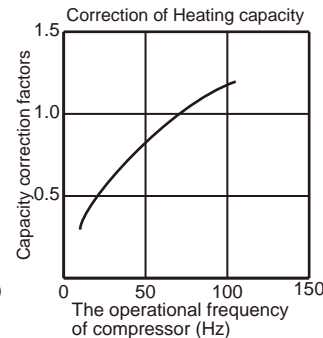
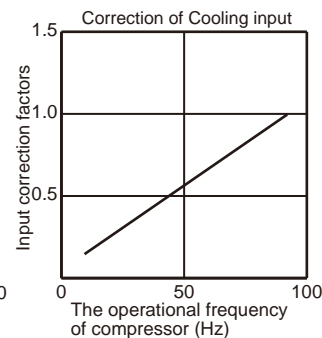
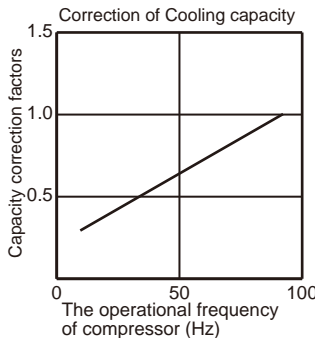

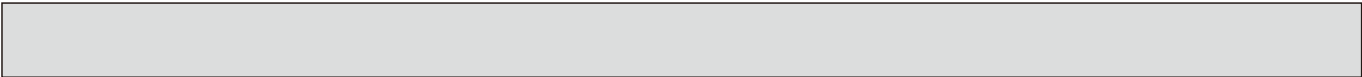

**MUZ-HR60VF**

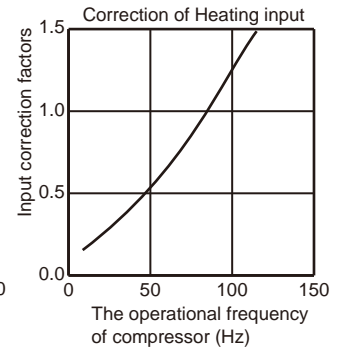
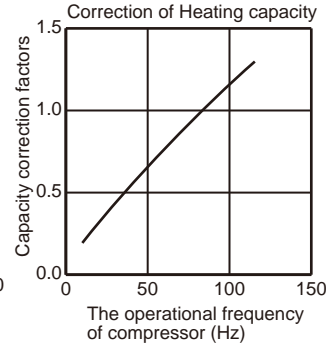
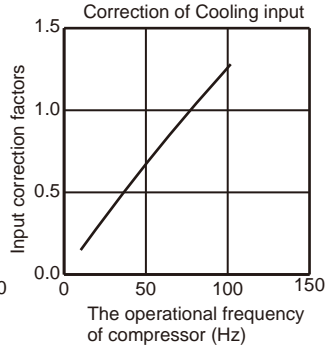
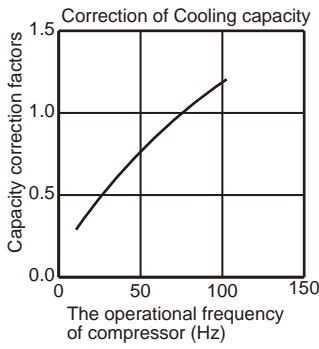

**MUZ-HR71VF**

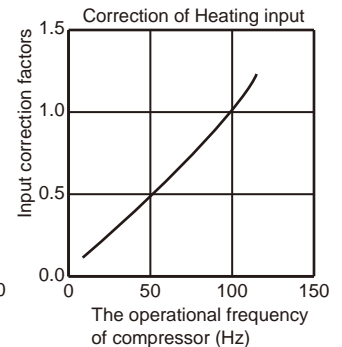
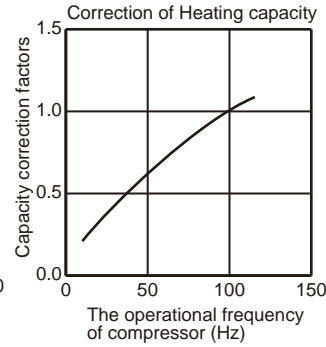
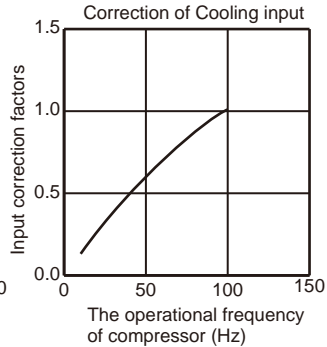
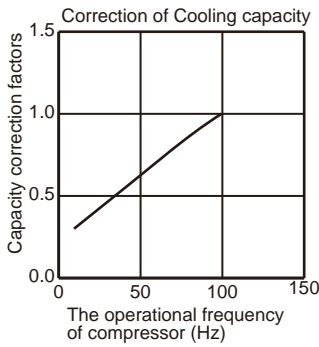

### 9-3. HOW TO OPERATE FIXED-FREQUENCY OPERATION

<Test run operation>

1. Press EMERGENCY OPERATION switch to start COOL or HEAT mode (COOL: Press once, HEAT: Press twice).
2. Test run operation starts and continues to operate for 30 minutes.
3. Compressor operates at rated frequency in COOL mode or 58 Hz in HEAT mode.
4. Indoor fan operates at High speed.
5. After 30 minutes, test run operation finishes and EMERGENCY OPERATION starts (operation frequency of compressor varies).
6. To cancel test run operation (EMERGENCY OPERATION), press EMERGENCY OPERATION switch or any button on remote controller.

### 9-4. OUTDOOR LOW PRESSURE AND OUTDOOR UNIT CURRENT

#### COOL operation

- ① Both indoor and outdoor unit are under the same temperature/humidity condition.
- ② Operation: TEST RUN OPERATION (Refer to 9-3.)

Dry-bulb temperature (°C)	Relative humidity (%)
20	50
25	60
30	70

#### Outdoor low pressure

**MUZ-HR25VF**

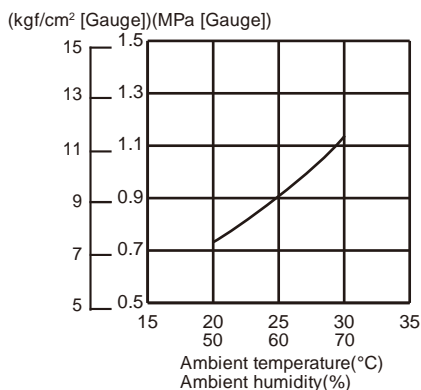

**MUZ-HR35VF**

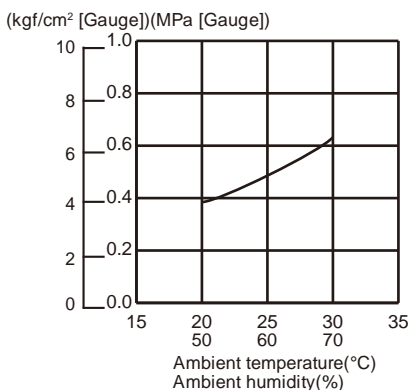

**MUZ-HR42VF**

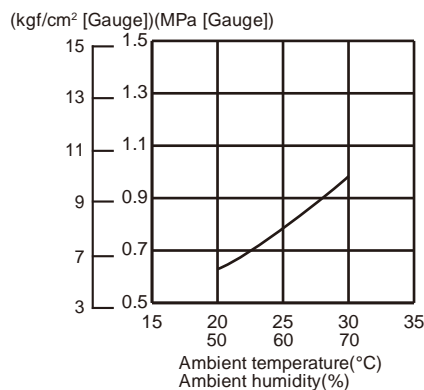

**MUZ-HR50VF**

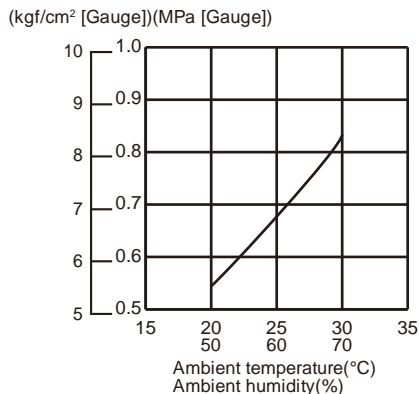

**MUZ-HR60VF**

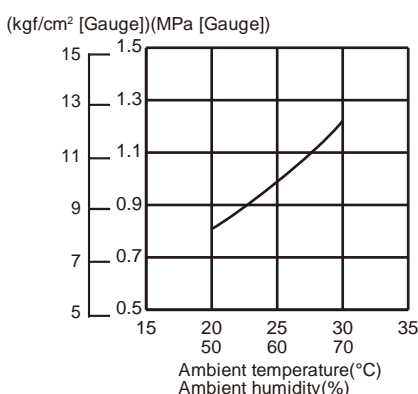

**MUZ-HR71VF**

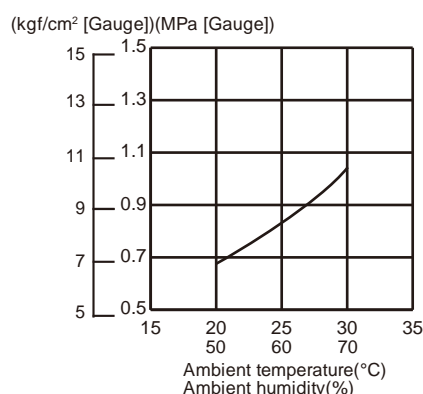

**NOTE:**

The unit of pressure has been changed to MPa on the international system of units (SI unit system)  
 The conversion factor is: **1 (MPa [Gauge]) = 10.2 (kgf/cm² [Gauge])**

**Outdoor unit current**

**MUZ-HR25VF**

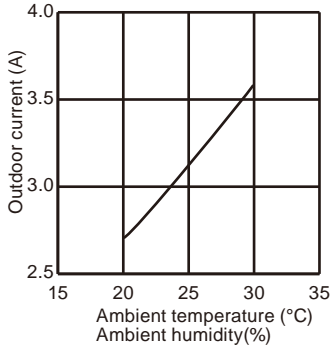

**MUZ-HR35VF**

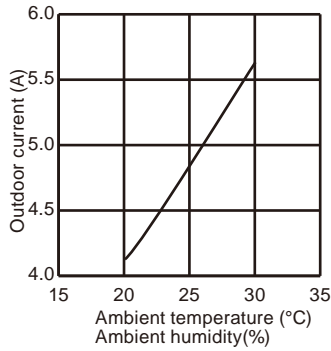

**MUZ-HR42VF**

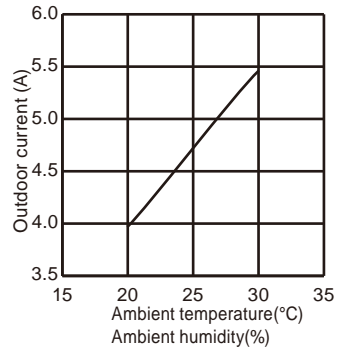

**MUZ-HR50VF**

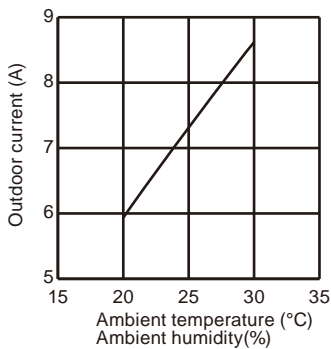

**MUZ-HR60VF**

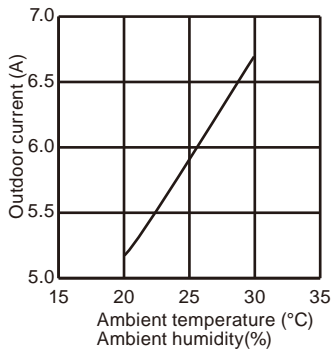

**MUZ-HR71VF**

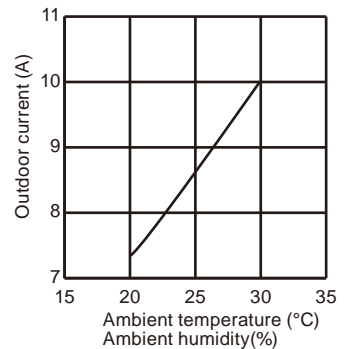

**HEAT operation**

① Condition:

	Indoor	Outdoor			
Dry bulb temperature (°C)	20.0	2	7	15	20.0
Wet bulb temperature (°C)	14.5	1	6	12	14.5

② Operation: Test run operation (Refer to 9-3.)

**Outdoor unit current**

**MUZ-HR25VF**

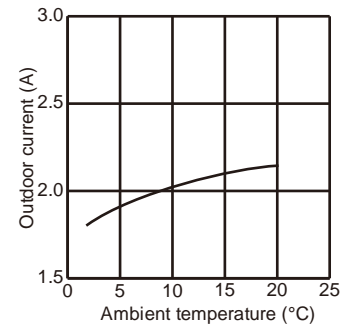

**MUZ-HR35VF**

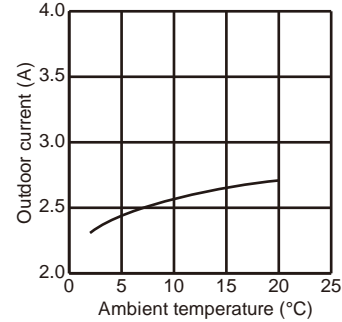

**MUZ-HR42VF**

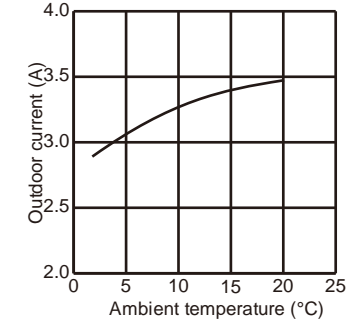

**MUZ-HR50VF**

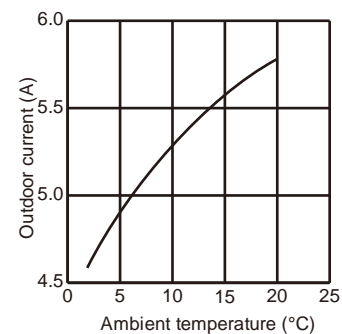

**MUZ-HR60VF**

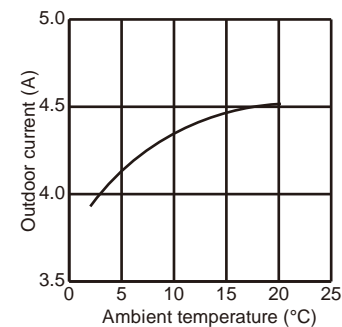

**MUZ-HR71VF**

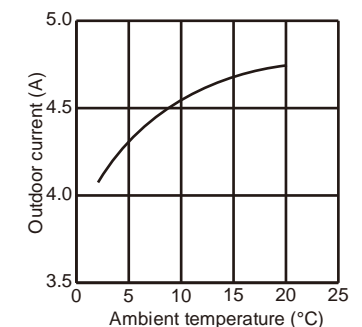

**PERFORMANCE DATA COOL operation at Rated frequency**

**MUZ-HR25VF**

CAPACITY: 2.5 KW

SHF: 0.78

INPUT: 800 W

INDOOR DB (°C)	INDOOR WB (°C)	OUTDOOR DB (°C)															
		21				25				27				30			
		Q	SHC	SHF	INPUT	Q	SHC	SHF	INPUT	Q	SHC	SHF	INPUT	Q	SHC	SHF	INPUT
21	18	2.94	1.76	0.60	640	2.81	1.69	0.60	672	2.70	1.62	0.60	704	2.60	1.56	0.60	736
21	20	3.06	1.47	0.48	672	2.94	1.41	0.48	712	2.85	1.37	0.48	728	2.75	1.32	0.48	760
22	18	2.94	1.88	0.64	640	2.81	1.80	0.64	672	2.70	1.73	0.64	704	2.60	1.66	0.64	736
22	20	3.06	1.59	0.52	672	2.94	1.53	0.52	712	2.85	1.48	0.52	728	2.75	1.43	0.52	760
22	22	3.19	1.28	0.40	696	3.08	1.23	0.40	740	3.00	1.20	0.40	760	2.88	1.15	0.40	792
23	18	2.94	2.00	0.68	640	2.81	1.91	0.68	672	2.70	1.84	0.68	704	2.60	1.77	0.68	736
23	20	3.06	1.72	0.56	672	2.94	1.65	0.56	712	2.85	1.60	0.56	728	2.75	1.54	0.56	760
23	22	3.19	1.40	0.44	696	3.08	1.35	0.44	740	3.00	1.32	0.44	760	2.88	1.27	0.44	792
24	18	2.94	2.12	0.72	640	2.81	2.03	0.72	672	2.70	1.94	0.72	704	2.60	1.87	0.72	736
24	20	3.06	1.84	0.60	672	2.94	1.76	0.60	712	2.85	1.71	0.60	728	2.75	1.65	0.60	760
24	22	3.19	1.53	0.48	696	3.08	1.48	0.48	740	3.00	1.44	0.48	760	2.88	1.38	0.48	792
24	24	3.35	1.21	0.36	728	3.23	1.16	0.36	768	3.15	1.13	0.36	792	3.05	1.10	0.36	832
25	18	2.94	2.23	0.76	640	2.81	2.14	0.76	672	2.70	2.05	0.76	704	2.60	1.98	0.76	736
25	20	3.06	1.96	0.64	672	2.94	1.88	0.64	712	2.85	1.82	0.64	728	2.75	1.76	0.64	760
25	22	3.19	1.66	0.52	696	3.08	1.60	0.52	740	3.00	1.56	0.52	760	2.88	1.50	0.52	792
25	24	3.35	1.34	0.40	728	3.23	1.29	0.40	768	3.15	1.26	0.40	792	3.05	1.22	0.40	832
26	18	2.94	2.35	0.80	640	2.81	2.25	0.80	672	2.70	2.16	0.80	704	2.60	2.08	0.80	736
26	20	3.06	2.08	0.68	672	2.94	2.00	0.68	712	2.85	1.94	0.68	728	2.75	1.87	0.68	760
26	22	3.19	1.79	0.56	696	3.08	1.72	0.56	740	3.00	1.68	0.56	760	2.88	1.61	0.56	792
26	24	3.35	1.47	0.44	728	3.23	1.42	0.44	768	3.15	1.39	0.44	792	3.05	1.34	0.44	832
26	26	3.45	1.10	0.32	768	3.35	1.07	0.32	808	3.30	1.06	0.32	832	3.20	1.02	0.32	856
27	18	2.94	2.47	0.84	640	2.81	2.36	0.84	672	2.70	2.27	0.84	704	2.60	2.18	0.84	736
27	20	3.06	2.21	0.72	672	2.94	2.12	0.72	712	2.85	2.05	0.72	728	2.75	1.98	0.72	760
27	22	3.19	1.91	0.60	696	3.08	1.85	0.60	740	3.00	1.80	0.60	760	2.88	1.73	0.60	792
27	24	3.35	1.61	0.48	728	3.23	1.55	0.48	768	3.15	1.51	0.48	792	3.05	1.46	0.48	832
27	26	3.45	1.24	0.36	768	3.35	1.21	0.36	808	3.30	1.19	0.36	832	3.20	1.15	0.36	856
28	18	2.94	2.59	0.88	640	2.81	2.48	0.88	672	2.70	2.38	0.88	704	2.60	2.29	0.88	736
28	20	3.06	2.33	0.76	672	2.94	2.23	0.76	712	2.85	2.17	0.76	728	2.75	2.09	0.76	760
28	22	3.19	2.04	0.64	696	3.08	1.97	0.64	740	3.00	1.92	0.64	760	2.88	1.84	0.64	792
28	24	3.35	1.74	0.52	728	3.23	1.68	0.52	768	3.15	1.64	0.52	792	3.05	1.59	0.52	832
28	26	3.45	1.38	0.40	768	3.35	1.34	0.40	808	3.30	1.32	0.40	832	3.20	1.28	0.40	856
29	18	2.94	2.70	0.92	640	2.81	2.59	0.92	672	2.70	2.48	0.92	704	2.60	2.39	0.92	736
29	20	3.06	2.45	0.80	672	2.94	2.35	0.80	712	2.85	2.28	0.80	728	2.75	2.20	0.80	760
29	22	3.19	2.17	0.68	696	3.08	2.09	0.68	740	3.00	2.04	0.68	760	2.88	1.96	0.68	792
29	24	3.35	1.88	0.56	728	3.23	1.81	0.56	768	3.15	1.76	0.56	792	3.05	1.71	0.56	832
29	26	3.45	1.52	0.44	768	3.35	1.47	0.44	808	3.30	1.45	0.44	832	3.20	1.41	0.44	856
30	18	2.94	2.82	0.96	640	2.81	2.70	0.96	672	2.70	2.59	0.96	704	2.60	2.50	0.96	736
30	20	3.06	2.57	0.84	672	2.94	2.47	0.84	712	2.85	2.39	0.84	728	2.75	2.31	0.84	760
30	22	3.19	2.30	0.72	696	3.08	2.21	0.72	740	3.00	2.16	0.72	760	2.88	2.07	0.72	792
30	24	3.35	2.01	0.60	728	3.23	1.94	0.60	768	3.15	1.89	0.60	792	3.05	1.83	0.60	832
30	26	3.45	1.66	0.48	768	3.35	1.61	0.48	808	3.30	1.58	0.48	832	3.20	1.54	0.48	856
31	18	2.94	2.94	1.00	640	2.81	2.81	1.00	672	2.70	2.70	1.00	704	2.60	2.60	1.00	736
31	20	3.06	2.70	0.88	672	2.94	2.59	0.88	712	2.85	2.51	0.88	728	2.75	2.42	0.88	760
31	22	3.19	2.42	0.76	696	3.08	2.34	0.76	740	3.00	2.28	0.76	760	2.88	2.19	0.76	792
31	24	3.35	2.14	0.64	728	3.23	2.06	0.64	768	3.15	2.02	0.64	792	3.05	1.95	0.64	832
31	26	3.45	1.79	0.52	768	3.35	1.74	0.52	808	3.30	1.72	0.52	832	3.20	1.66	0.52	856
32	18	2.94	2.94	1.00	640	2.81	2.81	1.00	672	2.70	2.70	1.00	704	2.60	2.60	1.00	736
32	20	3.06	2.82	0.92	672	2.94	2.70	0.92	712	2.85	2.62	0.92	728	2.75	2.53	0.92	760
32	22	3.19	2.55	0.80	696	3.08	2.46	0.80	740	3.00	2.40	0.80	760	2.88	2.30	0.80	792
32	24	3.35	2.28	0.68	728	3.23	2.19	0.68	768	3.15	2.14	0.68	792	3.05	2.07	0.68	832
32	26	3.45	1.93	0.56	768	3.35	1.88	0.56	808	3.30	1.85	0.56	832	3.20	1.79	0.56	856

**NOTE** Q : Total capacity (kW) SHF : Sensible heat factor DB : Dry-bulb temperature  
 SHC : Sensible heat capacity (kW) INPUT : Total power input (W) WB : Wet-bulb temperature

**PERFORMANCE DATA COOL operation at Rated frequency**

**MUZ-HR25VF**

CAPACITY: 2.5 kW

SHF: 0.78

INPUT: 800 W

INDOOR DB (°C)	INDOOR WB (°C)	OUTDOOR DB (°C)											
		35				40				46			
		Q	SHC	SHF	INPUT	Q	SHC	SHF	INPUT	Q	SHC	SHF	INPUT
21	18	2.45	1.47	0.60	784	2.25	1.35	0.60	832	2.08	1.25	0.60	864
21	20	2.58	1.24	0.48	816	2.40	1.15	0.48	856	2.23	1.07	0.48	904
22	18	2.45	1.57	0.64	784	2.25	1.44	0.64	832	2.08	1.33	0.64	864
22	20	2.58	1.34	0.52	816	2.40	1.25	0.52	856	2.23	1.16	0.52	904
22	22	2.73	1.09	0.40	848	2.55	1.02	0.40	896	2.38	0.95	0.40	928
23	18	2.45	1.67	0.68	784	2.25	1.53	0.68	832	2.08	1.41	0.68	864
23	20	2.58	1.44	0.56	816	2.40	1.34	0.56	856	2.23	1.25	0.56	904
23	22	2.73	1.20	0.44	848	2.55	1.12	0.44	896	2.38	1.05	0.44	928
24	18	2.45	1.76	0.72	784	2.25	1.62	0.72	832	2.08	1.49	0.72	864
24	20	2.58	1.55	0.60	816	2.40	1.44	0.60	856	2.23	1.34	0.60	904
24	22	2.73	1.31	0.48	848	2.55	1.22	0.48	896	2.38	1.14	0.48	928
24	24	2.88	1.04	0.36	880	2.70	0.97	0.36	920	2.55	0.92	0.36	960
25	18	2.45	1.86	0.76	784	2.25	1.71	0.76	832	2.08	1.58	0.76	864
25	20	2.58	1.65	0.64	816	2.40	1.54	0.64	856	2.23	1.42	0.64	904
25	22	2.73	1.42	0.52	848	2.55	1.33	0.52	896	2.38	1.24	0.52	928
25	24	2.88	1.15	0.40	880	2.70	1.08	0.40	920	2.55	1.02	0.40	960
26	18	2.45	1.96	0.80	784	2.25	1.80	0.80	832	2.08	1.66	0.80	864
26	20	2.58	1.75	0.68	816	2.40	1.63	0.68	856	2.23	1.51	0.68	904
26	22	2.73	1.53	0.56	848	2.55	1.43	0.56	896	2.38	1.33	0.56	928
26	24	2.88	1.27	0.44	880	2.70	1.19	0.44	920	2.55	1.12	0.44	960
26	26	3.03	0.97	0.32	912	2.85	0.91	0.32	952	2.68	0.86	0.32	992
27	18	2.45	2.06	0.84	784	2.25	1.89	0.84	832	2.08	1.74	0.84	864
27	20	2.58	1.85	0.72	816	2.40	1.73	0.72	856	2.23	1.60	0.72	904
27	22	2.73	1.64	0.60	848	2.55	1.53	0.60	896	2.38	1.43	0.60	928
27	24	2.88	1.38	0.48	880	2.70	1.30	0.48	920	2.55	1.22	0.48	960
27	26	3.03	1.09	0.36	912	2.85	1.03	0.36	952	2.68	0.96	0.36	992
28	18	2.45	2.16	0.88	784	2.25	1.98	0.88	832	2.08	1.83	0.88	864
28	20	2.58	1.96	0.76	816	2.40	1.82	0.76	856	2.23	1.69	0.76	904
28	22	2.73	1.74	0.64	848	2.55	1.63	0.64	896	2.38	1.52	0.64	928
28	24	2.88	1.50	0.52	880	2.70	1.40	0.52	920	2.55	1.33	0.52	960
28	26	3.03	1.21	0.40	912	2.85	1.14	0.40	952	2.68	1.07	0.40	992
29	18	2.45	2.25	0.92	784	2.25	2.07	0.92	832	2.08	1.91	0.92	864
29	20	2.58	2.06	0.80	816	2.40	1.92	0.80	856	2.23	1.78	0.80	904
29	22	2.73	1.85	0.68	848	2.55	1.73	0.68	896	2.38	1.62	0.68	928
29	24	2.88	1.61	0.56	880	2.70	1.51	0.56	920	2.55	1.43	0.56	960
29	26	3.03	1.33	0.44	912	2.85	1.25	0.44	952	2.68	1.18	0.44	992
30	18	2.45	2.35	0.96	784	2.25	2.16	0.96	832	2.08	1.99	0.96	864
30	20	2.58	2.16	0.84	816	2.40	2.02	0.84	856	2.23	1.87	0.84	904
30	22	2.73	1.96	0.72	848	2.55	1.84	0.72	896	2.38	1.71	0.72	928
30	24	2.88	1.73	0.60	880	2.70	1.62	0.60	920	2.55	1.53	0.60	960
30	26	3.03	1.45	0.48	912	2.85	1.37	0.48	952	2.68	1.28	0.48	992
31	18	2.45	2.45	1.00	784	2.25	2.25	1.00	832	2.08	2.08	1.00	864
31	20	2.58	2.27	0.88	816	2.40	2.11	0.88	856	2.23	1.96	0.88	904
31	22	2.73	2.07	0.76	848	2.55	1.94	0.76	896	2.38	1.81	0.76	928
31	24	2.88	1.84	0.64	880	2.70	1.73	0.64	920	2.55	1.63	0.64	960
31	26	3.03	1.57	0.52	912	2.85	1.48	0.52	952	2.68	1.39	0.52	992
32	18	2.45	2.45	1.00	784	2.25	2.25	1.00	832	2.08	2.08	1.00	864
32	20	2.58	2.37	0.92	816	2.40	2.21	0.92	856	2.23	2.05	0.92	904
32	22	2.73	2.18	0.80	848	2.55	2.04	0.80	896	2.38	1.90	0.80	928
32	24	2.88	1.96	0.68	880	2.70	1.84	0.68	920	2.55	1.73	0.68	960
32	26	3.03	1.69	0.56	912	2.85	1.60	0.56	952	2.68	1.50	0.56	992

**NOTE** Q : Total capacity (kW) SHF : Sensible heat factor DB : Dry-bulb temperature  
 SHC : Sensible heat capacity (kW) INPUT : Total power input (W) WB : Wet-bulb temperature

**PERFORMANCE DATA COOL operation at Rated frequency**

**MUZ-HR35VF**

CAPACITY: 3.4 kW

SHF: 0.78

INPUT: 1210 W

INDOOR DB (°C)	INDOOR WB (°C)	OUTDOOR DB (°C)															
		21				25				27				30			
		Q	SHC	SHF	INPUT	Q	SHC	SHF	INPUT	Q	SHC	SHF	INPUT	Q	SHC	SHF	INPUT
21	18	4.00	2.40	0.60	968	3.83	2.30	0.60	1016	3.67	2.20	0.60	1065	3.54	2.12	0.60	1113
21	20	4.17	2.00	0.48	1016	4.00	1.92	0.48	1077	3.88	1.86	0.48	1101	3.74	1.80	0.48	1150
22	18	4.00	2.56	0.64	968	3.83	2.45	0.64	1016	3.67	2.35	0.64	1065	3.54	2.26	0.64	1113
22	20	4.17	2.17	0.52	1016	4.00	2.08	0.52	1077	3.88	2.02	0.52	1101	3.74	1.94	0.52	1150
22	22	4.34	1.73	0.40	1053	4.18	1.67	0.40	1119	4.08	1.63	0.40	1150	3.91	1.56	0.40	1198
23	18	4.00	2.72	0.68	968	3.83	2.60	0.68	1016	3.67	2.50	0.68	1065	3.54	2.40	0.68	1113
23	20	4.17	2.33	0.56	1016	4.00	2.24	0.56	1077	3.88	2.17	0.56	1101	3.74	2.09	0.56	1150
23	22	4.34	1.91	0.44	1053	4.18	1.84	0.44	1119	4.08	1.80	0.44	1150	3.91	1.72	0.44	1198
24	18	4.00	2.88	0.72	968	3.83	2.75	0.72	1016	3.67	2.64	0.72	1065	3.54	2.55	0.72	1113
24	20	4.17	2.50	0.60	1016	4.00	2.40	0.60	1077	3.88	2.33	0.60	1101	3.74	2.24	0.60	1150
24	22	4.34	2.08	0.48	1053	4.18	2.01	0.48	1119	4.08	1.96	0.48	1150	3.91	1.88	0.48	1198
24	24	4.56	1.64	0.36	1101	4.39	1.58	0.36	1162	4.28	1.54	0.36	1198	4.15	1.49	0.36	1258
25	18	4.00	3.04	0.76	968	3.83	2.91	0.76	1016	3.67	2.79	0.76	1065	3.54	2.69	0.76	1113
25	20	4.17	2.67	0.64	1016	4.00	2.56	0.64	1077	3.88	2.48	0.64	1101	3.74	2.39	0.64	1150
25	22	4.34	2.25	0.52	1053	4.18	2.17	0.52	1119	4.08	2.12	0.52	1150	3.91	2.03	0.52	1198
25	24	4.56	1.82	0.40	1101	4.39	1.75	0.40	1162	4.28	1.71	0.40	1198	4.15	1.66	0.40	1258
26	18	4.00	3.20	0.80	968	3.83	3.06	0.80	1016	3.67	2.94	0.80	1065	3.54	2.83	0.80	1113
26	20	4.17	2.83	0.68	1016	4.00	2.72	0.68	1077	3.88	2.64	0.68	1101	3.74	2.54	0.68	1150
26	22	4.34	2.43	0.56	1053	4.18	2.34	0.56	1119	4.08	2.28	0.56	1150	3.91	2.19	0.56	1198
26	24	4.56	2.00	0.44	1101	4.39	1.93	0.44	1162	4.28	1.88	0.44	1198	4.15	1.83	0.44	1258
26	26	4.69	1.50	0.32	1162	4.56	1.46	0.32	1222	4.49	1.44	0.32	1258	4.35	1.39	0.32	1295
27	18	4.00	3.36	0.84	968	3.83	3.21	0.84	1016	3.67	3.08	0.84	1065	3.54	2.97	0.84	1113
27	20	4.17	3.00	0.72	1016	4.00	2.88	0.72	1077	3.88	2.79	0.72	1101	3.74	2.69	0.72	1150
27	22	4.34	2.60	0.60	1053	4.18	2.51	0.60	1119	4.08	2.45	0.60	1150	3.91	2.35	0.60	1198
27	24	4.56	2.19	0.48	1101	4.39	2.11	0.48	1162	4.28	2.06	0.48	1198	4.15	1.99	0.48	1258
27	26	4.69	1.69	0.36	1162	4.56	1.64	0.36	1222	4.49	1.62	0.36	1258	4.35	1.57	0.36	1295
28	18	4.00	3.52	0.88	968	3.83	3.37	0.88	1016	3.67	3.23	0.88	1065	3.54	3.11	0.88	1113
28	20	4.17	3.17	0.76	1016	4.00	3.04	0.76	1077	3.88	2.95	0.76	1101	3.74	2.84	0.76	1150
28	22	4.34	2.77	0.64	1053	4.18	2.68	0.64	1119	4.08	2.61	0.64	1150	3.91	2.50	0.64	1198
28	24	4.56	2.37	0.52	1101	4.39	2.28	0.52	1162	4.28	2.23	0.52	1198	4.15	2.16	0.52	1258
28	26	4.69	1.88	0.40	1162	4.56	1.82	0.40	1222	4.49	1.80	0.40	1258	4.35	1.74	0.40	1295
29	18	4.00	3.68	0.92	968	3.83	3.52	0.92	1016	3.67	3.38	0.92	1065	3.54	3.25	0.92	1113
29	20	4.17	3.33	0.80	1016	4.00	3.20	0.80	1077	3.88	3.10	0.80	1101	3.74	2.99	0.80	1150
29	22	4.34	2.95	0.68	1053	4.18	2.84	0.68	1119	4.08	2.77	0.68	1150	3.91	2.66	0.68	1198
29	24	4.56	2.55	0.56	1101	4.39	2.46	0.56	1162	4.28	2.40	0.56	1198	4.15	2.32	0.56	1258
29	26	4.69	2.06	0.44	1162	4.56	2.00	0.44	1222	4.49	1.97	0.44	1258	4.35	1.91	0.44	1295
30	18	4.00	3.84	0.96	968	3.83	3.67	0.96	1016	3.67	3.53	0.96	1065	3.54	3.39	0.96	1113
30	20	4.17	3.50	0.84	1016	4.00	3.36	0.84	1077	3.88	3.26	0.84	1101	3.74	3.14	0.84	1150
30	22	4.34	3.12	0.72	1053	4.18	3.01	0.72	1119	4.08	2.94	0.72	1150	3.91	2.82	0.72	1198
30	24	4.56	2.73	0.60	1101	4.39	2.63	0.60	1162	4.28	2.57	0.60	1198	4.15	2.49	0.60	1258
30	26	4.69	2.25	0.48	1162	4.56	2.19	0.48	1222	4.49	2.15	0.48	1258	4.35	2.09	0.48	1295
31	18	4.00	4.00	1.00	968	3.83	3.83	1.00	1016	3.67	3.67	1.00	1065	3.54	3.54	1.00	1113
31	20	4.17	3.67	0.88	1016	4.00	3.52	0.88	1077	3.88	3.41	0.88	1101	3.74	3.29	0.88	1150
31	22	4.34	3.29	0.76	1053	4.18	3.18	0.76	1119	4.08	3.10	0.76	1150	3.91	2.97	0.76	1198
31	24	4.56	2.92	0.64	1101	4.39	2.81	0.64	1162	4.28	2.74	0.64	1198	4.15	2.65	0.64	1258
31	26	4.69	2.44	0.52	1162	4.56	2.37	0.52	1222	4.49	2.33	0.52	1258	4.35	2.26	0.52	1295
32	18	4.00	4.00	1.00	968	3.83	3.83	1.00	1016	3.67	3.67	1.00	1065	3.54	3.54	1.00	1113
32	20	4.17	3.83	0.92	1016	4.00	3.68	0.92	1077	3.88	3.57	0.92	1101	3.74	3.44	0.92	1150
32	22	4.34	3.47	0.80	1053	4.18	3.35	0.80	1119	4.08	3.26	0.80	1150	3.91	3.13	0.80	1198
32	24	4.56	3.10	0.68	1101	4.39	2.98	0.68	1162	4.28	2.91	0.68	1198	4.15	2.82	0.68	1258
32	26	4.69	2.63	0.56	1162	4.56	2.55	0.56	1222	4.49	2.51	0.56	1258	4.35	2.44	0.56	1295

**NOTE** Q : Total capacity (kW) SHF : Sensible heat factor DB : Dry-bulb temperature  
 SHC : Sensible heat capacity (kW) INPUT : Total power input (W) WB : Wet-bulb temperature



**PERFORMANCE DATA COOL operation at Rated frequency**

**MUZ-HR35VF**

CAPACITY: 3.4 kW

SHF: 0.78

INPUT: 1210 W

INDOOR DB (°C)	INDOOR WB (°C)	OUTDOOR DB (°C)											
		35				40				46			
		Q	SHC	SHF	INPUT	Q	SHC	SHF	INPUT	Q	SHC	SHF	INPUT
21	18	3.33	2.00	0.60	1186	3.06	1.84	0.60	1258	2.82	1.69	0.60	1307
21	20	3.50	1.68	0.48	1234	3.26	1.57	0.48	1295	3.03	1.45	0.48	1367
22	18	3.33	2.13	0.64	1186	3.06	1.96	0.64	1258	2.82	1.81	0.64	1307
22	20	3.50	1.82	0.52	1234	3.26	1.70	0.52	1295	3.03	1.57	0.52	1367
22	22	3.71	1.48	0.40	1283	3.47	1.39	0.40	1355	3.23	1.29	0.40	1404
23	18	3.33	2.27	0.68	1186	3.06	2.08	0.68	1258	2.82	1.92	0.68	1307
23	20	3.50	1.96	0.56	1234	3.26	1.83	0.56	1295	3.03	1.69	0.56	1367
23	22	3.71	1.63	0.44	1283	3.47	1.53	0.44	1355	3.23	1.42	0.44	1404
24	18	3.33	2.40	0.72	1186	3.06	2.20	0.72	1258	2.82	2.03	0.72	1307
24	20	3.50	2.10	0.60	1234	3.26	1.96	0.60	1295	3.03	1.82	0.60	1367
24	22	3.71	1.78	0.48	1283	3.47	1.66	0.48	1355	3.23	1.55	0.48	1404
24	24	3.91	1.41	0.36	1331	3.67	1.32	0.36	1392	3.47	1.25	0.36	1452
25	18	3.33	2.53	0.76	1186	3.06	2.33	0.76	1258	2.82	2.14	0.76	1307
25	20	3.50	2.24	0.64	1234	3.26	2.09	0.64	1295	3.03	1.94	0.64	1367
25	22	3.71	1.93	0.52	1283	3.47	1.80	0.52	1355	3.23	1.68	0.52	1404
25	24	3.91	1.56	0.40	1331	3.67	1.47	0.40	1392	3.47	1.39	0.40	1452
26	18	3.33	2.67	0.80	1186	3.06	2.45	0.80	1258	2.82	2.26	0.80	1307
26	20	3.50	2.38	0.68	1234	3.26	2.22	0.68	1295	3.03	2.06	0.68	1367
26	22	3.71	2.08	0.56	1283	3.47	1.94	0.56	1355	3.23	1.81	0.56	1404
26	24	3.91	1.72	0.44	1331	3.67	1.62	0.44	1392	3.47	1.53	0.44	1452
26	26	4.11	1.32	0.32	1379	3.88	1.24	0.32	1440	3.64	1.16	0.32	1500
27	18	3.33	2.80	0.84	1186	3.06	2.57	0.84	1258	2.82	2.37	0.84	1307
27	20	3.50	2.52	0.72	1234	3.26	2.35	0.72	1295	3.03	2.18	0.72	1367
27	22	3.71	2.22	0.60	1283	3.47	2.08	0.60	1355	3.23	1.94	0.60	1404
27	24	3.91	1.88	0.48	1331	3.67	1.76	0.48	1392	3.47	1.66	0.48	1452
27	26	4.11	1.48	0.36	1379	3.88	1.40	0.36	1440	3.64	1.31	0.36	1500
28	18	3.33	2.93	0.88	1186	3.06	2.69	0.88	1258	2.82	2.48	0.88	1307
28	20	3.50	2.66	0.76	1234	3.26	2.48	0.76	1295	3.03	2.30	0.76	1367
28	22	3.71	2.37	0.64	1283	3.47	2.22	0.64	1355	3.23	2.07	0.64	1404
28	24	3.91	2.03	0.52	1331	3.67	1.91	0.52	1392	3.47	1.80	0.52	1452
28	26	4.11	1.65	0.40	1379	3.88	1.55	0.40	1440	3.64	1.46	0.40	1500
29	18	3.33	3.07	0.92	1186	3.06	2.82	0.92	1258	2.82	2.60	0.92	1307
29	20	3.50	2.80	0.80	1234	3.26	2.61	0.80	1295	3.03	2.42	0.80	1367
29	22	3.71	2.52	0.68	1283	3.47	2.36	0.68	1355	3.23	2.20	0.68	1404
29	24	3.91	2.19	0.56	1331	3.67	2.06	0.56	1392	3.47	1.94	0.56	1452
29	26	4.11	1.81	0.44	1379	3.88	1.71	0.44	1440	3.64	1.60	0.44	1500
30	18	3.33	3.20	0.96	1186	3.06	2.94	0.96	1258	2.82	2.71	0.96	1307
30	20	3.50	2.94	0.84	1234	3.26	2.74	0.84	1295	3.03	2.54	0.84	1367
30	22	3.71	2.67	0.72	1283	3.47	2.50	0.72	1355	3.23	2.33	0.72	1404
30	24	3.91	2.35	0.60	1331	3.67	2.20	0.60	1392	3.47	2.08	0.60	1452
30	26	4.11	1.97	0.48	1379	3.88	1.86	0.48	1440	3.64	1.75	0.48	1500
31	18	3.33	3.33	1.00	1186	3.06	3.06	1.00	1258	2.82	2.82	1.00	1307
31	20	3.50	3.08	0.88	1234	3.26	2.87	0.88	1295	3.03	2.66	0.88	1367
31	22	3.71	2.82	0.76	1283	3.47	2.64	0.76	1355	3.23	2.45	0.76	1404
31	24	3.91	2.50	0.64	1331	3.67	2.35	0.64	1392	3.47	2.22	0.64	1452
31	26	4.11	2.14	0.52	1379	3.88	2.02	0.52	1440	3.64	1.89	0.52	1500
32	18	3.33	3.33	1.00	1186	3.06	3.06	1.00	1258	2.82	2.82	1.00	1307
32	20	3.50	3.22	0.92	1234	3.26	3.00	0.92	1295	3.03	2.78	0.92	1367
32	22	3.71	2.96	0.80	1283	3.47	2.77	0.80	1355	3.23	2.58	0.80	1404
32	24	3.91	2.66	0.68	1331	3.67	2.50	0.68	1392	3.47	2.36	0.68	1452
32	26	4.11	2.30	0.56	1379	3.88	2.17	0.56	1440	3.64	2.04	0.56	1500

**NOTE** Q : Total capacity (kW) SHF : Sensible heat factor DB : Dry-bulb temperature  
 SHC : Sensible heat capacity (kW) INPUT : Total power input (W) WB : Wet-bulb temperature

**PERFORMANCE DATA COOL operation at Rated frequency**

**MUZ-HR42VF**

CAPACITY: 4.2 kW

SHF: 0.74

INPUT: 1340 W

INDOOR DB (°C)	INDOOR WB (°C)	OUTDOOR DB (°C)															
		21				25				27				30			
		Q	SHC	SHF	INPUT	Q	SHC	SHF	INPUT	Q	SHC	SHF	INPUT	Q	SHC	SHF	INPUT
21	18	4.94	2.76	0.56	1072	4.73	2.65	0.56	1126	4.54	2.54	0.56	1179	4.37	2.45	0.56	1233
21	20	5.15	2.26	0.44	1126	4.94	2.17	0.44	1193	4.79	2.11	0.44	1219	4.62	2.03	0.44	1273
22	18	4.94	2.96	0.60	1072	4.73	2.84	0.60	1126	4.54	2.72	0.60	1179	4.37	2.62	0.60	1233
22	20	5.15	2.47	0.48	1126	4.94	2.37	0.48	1193	4.79	2.30	0.48	1219	4.62	2.22	0.48	1273
22	22	5.36	1.93	0.36	1166	5.17	1.86	0.36	1240	5.04	1.81	0.36	1273	4.83	1.74	0.36	1327
23	18	4.94	3.16	0.64	1072	4.73	3.02	0.64	1126	4.54	2.90	0.64	1179	4.37	2.80	0.64	1233
23	20	5.15	2.68	0.52	1126	4.94	2.57	0.52	1193	4.79	2.49	0.52	1219	4.62	2.40	0.52	1273
23	22	5.36	2.14	0.40	1166	5.17	2.07	0.40	1240	5.04	2.02	0.40	1273	4.83	1.93	0.40	1327
24	18	4.94	3.36	0.68	1072	4.73	3.21	0.68	1126	4.54	3.08	0.68	1179	4.37	2.97	0.68	1233
24	20	5.15	2.88	0.56	1126	4.94	2.76	0.56	1193	4.79	2.68	0.56	1219	4.62	2.59	0.56	1273
24	22	5.36	2.36	0.44	1166	5.17	2.27	0.44	1240	5.04	2.22	0.44	1273	4.83	2.13	0.44	1327
24	24	5.63	1.80	0.32	1219	5.42	1.73	0.32	1286	5.29	1.69	0.32	1327	5.12	1.64	0.32	1394
25	18	4.94	3.55	0.72	1072	4.73	3.40	0.72	1126	4.54	3.27	0.72	1179	4.37	3.14	0.72	1233
25	20	5.15	3.09	0.60	1126	4.94	2.96	0.60	1193	4.79	2.87	0.60	1219	4.62	2.77	0.60	1273
25	22	5.36	2.57	0.48	1166	5.17	2.48	0.48	1240	5.04	2.42	0.48	1273	4.83	2.32	0.48	1327
25	24	5.63	2.03	0.36	1219	5.42	1.95	0.36	1286	5.29	1.91	0.36	1327	5.12	1.84	0.36	1394
26	18	4.94	3.75	0.76	1072	4.73	3.59	0.76	1126	4.54	3.45	0.76	1179	4.37	3.32	0.76	1233
26	20	5.15	3.29	0.64	1126	4.94	3.16	0.64	1193	4.79	3.06	0.64	1219	4.62	2.96	0.64	1273
26	22	5.36	2.78	0.52	1166	5.17	2.69	0.52	1240	5.04	2.62	0.52	1273	4.83	2.51	0.52	1327
26	24	5.63	2.25	0.40	1219	5.42	2.17	0.40	1286	5.29	2.12	0.40	1327	5.12	2.05	0.40	1394
26	26	5.80	1.62	0.28	1286	5.63	1.58	0.28	1353	5.54	1.55	0.28	1394	5.38	1.51	0.28	1434
27	18	4.94	3.95	0.80	1072	4.73	3.78	0.80	1126	4.54	3.63	0.80	1179	4.37	3.49	0.80	1233
27	20	5.15	3.50	0.68	1126	4.94	3.36	0.68	1193	4.79	3.26	0.68	1219	4.62	3.14	0.68	1273
27	22	5.36	3.00	0.56	1166	5.17	2.89	0.56	1240	5.04	2.82	0.56	1273	4.83	2.70	0.56	1327
27	24	5.63	2.48	0.44	1219	5.42	2.38	0.44	1286	5.29	2.33	0.44	1327	5.12	2.25	0.44	1394
27	26	5.80	1.85	0.32	1286	5.63	1.80	0.32	1353	5.54	1.77	0.32	1394	5.38	1.72	0.32	1434
28	18	4.94	4.15	0.84	1072	4.73	3.97	0.84	1126	4.54	3.81	0.84	1179	4.37	3.67	0.84	1233
28	20	5.15	3.70	0.72	1126	4.94	3.55	0.72	1193	4.79	3.45	0.72	1219	4.62	3.33	0.72	1273
28	22	5.36	3.21	0.60	1166	5.17	3.10	0.60	1240	5.04	3.02	0.60	1273	4.83	2.90	0.60	1327
28	24	5.63	2.70	0.48	1219	5.42	2.60	0.48	1286	5.29	2.54	0.48	1327	5.12	2.46	0.48	1394
28	26	5.80	2.09	0.36	1286	5.63	2.03	0.36	1353	5.54	2.00	0.36	1394	5.38	1.94	0.36	1434
29	18	4.94	4.34	0.88	1072	4.73	4.16	0.88	1126	4.54	3.99	0.88	1179	4.37	3.84	0.88	1233
29	20	5.15	3.91	0.76	1126	4.94	3.75	0.76	1193	4.79	3.64	0.76	1219	4.62	3.51	0.76	1273
29	22	5.36	3.43	0.64	1166	5.17	3.31	0.64	1240	5.04	3.23	0.64	1273	4.83	3.09	0.64	1327
29	24	5.63	2.93	0.52	1219	5.42	2.82	0.52	1286	5.29	2.75	0.52	1327	5.12	2.66	0.52	1394
29	26	5.80	2.32	0.40	1286	5.63	2.25	0.40	1353	5.54	2.22	0.40	1394	5.38	2.15	0.40	1434
30	18	4.94	4.54	0.92	1072	4.73	4.35	0.92	1126	4.54	4.17	0.92	1179	4.37	4.02	0.92	1233
30	20	5.15	4.12	0.80	1126	4.94	3.95	0.80	1193	4.79	3.83	0.80	1219	4.62	3.70	0.80	1273
30	22	5.36	3.64	0.68	1166	5.17	3.51	0.68	1240	5.04	3.43	0.68	1273	4.83	3.28	0.68	1327
30	24	5.63	3.15	0.56	1219	5.42	3.03	0.56	1286	5.29	2.96	0.56	1327	5.12	2.87	0.56	1394
30	26	5.80	2.55	0.44	1286	5.63	2.48	0.44	1353	5.54	2.44	0.44	1394	5.38	2.37	0.44	1434
31	18	4.94	4.74	0.96	1072	4.73	4.54	0.96	1126	4.54	4.35	0.96	1179	4.37	4.19	0.96	1233
31	20	5.15	4.32	0.84	1126	4.94	4.15	0.84	1193	4.79	4.02	0.84	1219	4.62	3.88	0.84	1273
31	22	5.36	3.86	0.72	1166	5.17	3.72	0.72	1240	5.04	3.63	0.72	1273	4.83	3.48	0.72	1327
31	24	5.63	3.38	0.60	1219	5.42	3.25	0.60	1286	5.29	3.18	0.60	1327	5.12	3.07	0.60	1394
31	26	5.80	2.78	0.48	1286	5.63	2.70	0.48	1353	5.54	2.66	0.48	1394	5.38	2.58	0.48	1434
32	18	4.94	4.94	1.00	1072	4.73	4.73	1.00	1126	4.54	4.54	1.00	1179	4.37	4.37	1.00	1233
32	20	5.15	4.53	0.88	1126	4.94	4.34	0.88	1193	4.79	4.21	0.88	1219	4.62	4.07	0.88	1273
32	22	5.36	4.07	0.76	1166	5.17	3.93	0.76	1240	5.04	3.83	0.76	1273	4.83	3.67	0.76	1327
32	24	5.63	3.60	0.64	1219	5.42	3.47	0.64	1286	5.29	3.39	0.64	1327	5.12	3.28	0.64	1394
32	26	5.80	3.01	0.52	1286	5.63	2.93	0.52	1353	5.54	2.88	0.52	1394	5.38	2.80	0.52	1434

**NOTE** Q : Total capacity (kW) SHF : Sensible heat factor DB : Dry-bulb temperature  
 SHC : Sensible heat capacity (kW) INPUT : Total power input (W) WB : Wet-bulb temperature

**PERFORMANCE DATA COOL operation at Rated frequency**

**MUZ-HR42VF**

CAPACITY: 4.2 kW

SHF: 0.74

INPUT: 1340 W

INDOOR DB (°C)	INDOOR WB (°C)	OUTDOOR DB (°C)											
		35				40				46			
		Q	SHC	SHF	INPUT	Q	SHC	SHF	INPUT	Q	SHC	SHF	INPUT
21	18	4.12	2.30	0.56	1313	3.78	2.12	0.56	1394	3.49	1.95	0.56	1447
21	20	4.33	1.90	0.44	1367	4.03	1.77	0.44	1434	3.74	1.64	0.44	1514
22	18	4.12	2.47	0.60	1313	3.78	2.27	0.60	1394	3.49	2.09	0.60	1447
22	20	4.33	2.08	0.48	1367	4.03	1.94	0.48	1434	3.74	1.79	0.48	1514
22	22	4.58	1.65	0.36	1420	4.28	1.54	0.36	1501	3.99	1.44	0.36	1554
23	18	4.12	2.63	0.64	1313	3.78	2.42	0.64	1394	3.49	2.23	0.64	1447
23	20	4.33	2.25	0.52	1367	4.03	2.10	0.52	1434	3.74	1.94	0.52	1514
23	22	4.58	1.83	0.40	1420	4.28	1.71	0.40	1501	3.99	1.60	0.40	1554
24	18	4.12	2.80	0.68	1313	3.78	2.57	0.68	1394	3.49	2.37	0.68	1447
24	20	4.33	2.42	0.56	1367	4.03	2.26	0.56	1434	3.74	2.09	0.56	1514
24	22	4.58	2.01	0.44	1420	4.28	1.88	0.44	1501	3.99	1.76	0.44	1554
24	24	4.83	1.55	0.32	1474	4.54	1.45	0.32	1541	4.28	1.37	0.32	1608
25	18	4.12	2.96	0.72	1313	3.78	2.72	0.72	1394	3.49	2.51	0.72	1447
25	20	4.33	2.60	0.60	1367	4.03	2.42	0.60	1434	3.74	2.24	0.60	1514
25	22	4.58	2.20	0.48	1420	4.28	2.06	0.48	1501	3.99	1.92	0.48	1554
25	24	4.83	1.74	0.36	1474	4.54	1.63	0.36	1541	4.28	1.54	0.36	1608
26	18	4.12	3.13	0.76	1313	3.78	2.87	0.76	1394	3.49	2.65	0.76	1447
26	20	4.33	2.77	0.64	1367	4.03	2.58	0.64	1434	3.74	2.39	0.64	1514
26	22	4.58	2.38	0.52	1420	4.28	2.23	0.52	1501	3.99	2.07	0.52	1554
26	24	4.83	1.93	0.40	1474	4.54	1.81	0.40	1541	4.28	1.71	0.40	1608
26	26	5.08	1.42	0.28	1528	4.79	1.34	0.28	1595	4.49	1.26	0.28	1662
27	18	4.12	3.29	0.80	1313	3.78	3.02	0.80	1394	3.49	2.79	0.80	1447
27	20	4.33	2.94	0.68	1367	4.03	2.74	0.68	1434	3.74	2.54	0.68	1514
27	22	4.58	2.56	0.56	1420	4.28	2.40	0.56	1501	3.99	2.23	0.56	1554
27	24	4.83	2.13	0.44	1474	4.54	2.00	0.44	1541	4.28	1.88	0.44	1608
27	26	5.08	1.63	0.32	1528	4.79	1.53	0.32	1595	4.49	1.44	0.32	1662
28	18	4.12	3.46	0.84	1313	3.78	3.18	0.84	1394	3.49	2.93	0.84	1447
28	20	4.33	3.11	0.72	1367	4.03	2.90	0.72	1434	3.74	2.69	0.72	1514
28	22	4.58	2.75	0.60	1420	4.28	2.57	0.60	1501	3.99	2.39	0.60	1554
28	24	4.83	2.32	0.48	1474	4.54	2.18	0.48	1541	4.28	2.06	0.48	1608
28	26	5.08	1.83	0.36	1528	4.79	1.72	0.36	1595	4.49	1.62	0.36	1662
29	18	4.12	3.62	0.88	1313	3.78	3.33	0.88	1394	3.49	3.07	0.88	1447
29	20	4.33	3.29	0.76	1367	4.03	3.06	0.76	1434	3.74	2.84	0.76	1514
29	22	4.58	2.93	0.64	1420	4.28	2.74	0.64	1501	3.99	2.55	0.64	1554
29	24	4.83	2.51	0.52	1474	4.54	2.36	0.52	1541	4.28	2.23	0.52	1608
29	26	5.08	2.03	0.40	1528	4.79	1.92	0.40	1595	4.49	1.80	0.40	1662
30	18	4.12	3.79	0.92	1313	3.78	3.48	0.92	1394	3.49	3.21	0.92	1447
30	20	4.33	3.46	0.80	1367	4.03	3.23	0.80	1434	3.74	2.99	0.80	1514
30	22	4.58	3.11	0.68	1420	4.28	2.91	0.68	1501	3.99	2.71	0.68	1554
30	24	4.83	2.70	0.56	1474	4.54	2.54	0.56	1541	4.28	2.40	0.56	1608
30	26	5.08	2.24	0.44	1528	4.79	2.11	0.44	1595	4.49	1.98	0.44	1662
31	18	4.12	3.95	0.96	1313	3.78	3.63	0.96	1394	3.49	3.35	0.96	1447
31	20	4.33	3.63	0.84	1367	4.03	3.39	0.84	1434	3.74	3.14	0.84	1514
31	22	4.58	3.30	0.72	1420	4.28	3.08	0.72	1501	3.99	2.87	0.72	1554
31	24	4.83	2.90	0.60	1474	4.54	2.72	0.60	1541	4.28	2.57	0.60	1608
31	26	5.08	2.44	0.48	1528	4.79	2.30	0.48	1595	4.49	2.16	0.48	1662
32	18	4.12	4.12	1.00	1313	3.78	3.78	1.00	1394	3.49	3.49	1.00	1447
32	20	4.33	3.81	0.88	1367	4.03	3.55	0.88	1434	3.74	3.29	0.88	1514
32	22	4.58	3.48	0.76	1420	4.28	3.26	0.76	1501	3.99	3.03	0.76	1554
32	24	4.83	3.09	0.64	1474	4.54	2.90	0.64	1541	4.28	2.74	0.64	1608
32	26	5.08	2.64	0.52	1528	4.79	2.49	0.52	1595	4.49	2.34	0.52	1662

**NOTE** Q : Total capacity (kW) SHF : Sensible heat factor DB : Dry-bulb temperature  
 SHC : Sensible heat capacity (kW) INPUT : Total power input (W) WB : Wet-bulb temperature

**PERFORMANCE DATA COOL operation at Rated frequency**

**MUZ-HR50VF**

CAPACITY: 5.0 kW

SHF: 0.73

INPUT: 2050 W

INDOOR DB (°C)	INDOOR WB (°C)	OUTDOOR DB (°C)															
		21				25				27				30			
		Q	SHC	SHF	INPUT	Q	SHC	SHF	INPUT	Q	SHC	SHF	INPUT	Q	SHC	SHF	INPUT
21	18	5.88	3.23	0.55	1640	5.63	3.09	0.55	1722	5.40	2.97	0.55	1804	5.20	2.86	0.55	1886
21	20	6.13	2.63	0.43	1722	5.88	2.53	0.43	1825	5.70	2.45	0.43	1866	5.50	2.37	0.43	1948
22	18	5.88	3.47	0.59	1640	5.63	3.32	0.59	1722	5.40	3.19	0.59	1804	5.20	3.07	0.59	1886
22	20	6.13	2.88	0.47	1722	5.88	2.76	0.47	1825	5.70	2.68	0.47	1866	5.50	2.59	0.47	1948
22	22	6.38	2.23	0.35	1784	6.15	2.15	0.35	1896	6.00	2.10	0.35	1948	5.75	2.01	0.35	2030
23	18	5.88	3.70	0.63	1640	5.63	3.54	0.63	1722	5.40	3.40	0.63	1804	5.20	3.28	0.63	1886
23	20	6.13	3.12	0.51	1722	5.88	3.00	0.51	1825	5.70	2.91	0.51	1866	5.50	2.81	0.51	1948
23	22	6.38	2.49	0.39	1784	6.15	2.40	0.39	1896	6.00	2.34	0.39	1948	5.75	2.24	0.39	2030
24	18	5.88	3.94	0.67	1640	5.63	3.77	0.67	1722	5.40	3.62	0.67	1804	5.20	3.48	0.67	1886
24	20	6.13	3.37	0.55	1722	5.88	3.23	0.55	1825	5.70	3.14	0.55	1866	5.50	3.03	0.55	1948
24	22	6.38	2.74	0.43	1784	6.15	2.64	0.43	1896	6.00	2.58	0.43	1948	5.75	2.47	0.43	2030
24	24	6.70	2.08	0.31	1866	6.45	2.00	0.31	1968	6.30	1.95	0.31	2030	6.10	1.89	0.31	2132
25	18	5.88	4.17	0.71	1640	5.63	3.99	0.71	1722	5.40	3.83	0.71	1804	5.20	3.69	0.71	1886
25	20	6.13	3.61	0.59	1722	5.88	3.47	0.59	1825	5.70	3.36	0.59	1866	5.50	3.25	0.59	1948
25	22	6.38	3.00	0.47	1784	6.15	2.89	0.47	1896	6.00	2.82	0.47	1948	5.75	2.70	0.47	2030
25	24	6.70	2.35	0.35	1866	6.45	2.26	0.35	1968	6.30	2.21	0.35	2030	6.10	2.14	0.35	2132
26	18	5.88	4.41	0.75	1640	5.63	4.22	0.75	1722	5.40	4.05	0.75	1804	5.20	3.90	0.75	1886
26	20	6.13	3.86	0.63	1722	5.88	3.70	0.63	1825	5.70	3.59	0.63	1866	5.50	3.47	0.63	1948
26	22	6.38	3.25	0.51	1784	6.15	3.14	0.51	1896	6.00	3.06	0.51	1948	5.75	2.93	0.51	2030
26	24	6.70	2.61	0.39	1866	6.45	2.52	0.39	1968	6.30	2.46	0.39	2030	6.10	2.38	0.39	2132
26	26	6.90	1.86	0.27	1968	6.70	1.81	0.27	2071	6.60	1.78	0.27	2132	6.40	1.73	0.27	2194
27	18	5.88	4.64	0.79	1640	5.63	4.44	0.79	1722	5.40	4.27	0.79	1804	5.20	4.11	0.79	1886
27	20	6.13	4.10	0.67	1722	5.88	3.94	0.67	1825	5.70	3.82	0.67	1866	5.50	3.69	0.67	1948
27	22	6.38	3.51	0.55	1784	6.15	3.38	0.55	1896	6.00	3.30	0.55	1948	5.75	3.16	0.55	2030
27	24	6.70	2.88	0.43	1866	6.45	2.77	0.43	1968	6.30	2.71	0.43	2030	6.10	2.62	0.43	2132
27	26	6.90	2.14	0.31	1968	6.70	2.08	0.31	2071	6.60	2.05	0.31	2132	6.40	1.98	0.31	2194
28	18	5.88	4.88	0.83	1640	5.63	4.67	0.83	1722	5.40	4.48	0.83	1804	5.20	4.32	0.83	1886
28	20	6.13	4.35	0.71	1722	5.88	4.17	0.71	1825	5.70	4.05	0.71	1866	5.50	3.91	0.71	1948
28	22	6.38	3.76	0.59	1784	6.15	3.63	0.59	1896	6.00	3.54	0.59	1948	5.75	3.39	0.59	2030
28	24	6.70	3.15	0.47	1866	6.45	3.03	0.47	1968	6.30	2.96	0.47	2030	6.10	2.87	0.47	2132
28	26	6.90	2.42	0.35	1968	6.70	2.35	0.35	2071	6.60	2.31	0.35	2132	6.40	2.24	0.35	2194
29	18	5.88	5.11	0.87	1640	5.63	4.89	0.87	1722	5.40	4.70	0.87	1804	5.20	4.52	0.87	1886
29	20	6.13	4.59	0.75	1722	5.88	4.41	0.75	1825	5.70	4.28	0.75	1866	5.50	4.13	0.75	1948
29	22	6.38	4.02	0.63	1784	6.15	3.87	0.63	1896	6.00	3.78	0.63	1948	5.75	3.62	0.63	2030
29	24	6.70	3.42	0.51	1866	6.45	3.29	0.51	1968	6.30	3.21	0.51	2030	6.10	3.11	0.51	2132
29	26	6.90	2.69	0.39	1968	6.70	2.61	0.39	2071	6.60	2.57	0.39	2132	6.40	2.50	0.39	2194
30	18	5.88	5.35	0.91	1640	5.63	5.12	0.91	1722	5.40	4.91	0.91	1804	5.20	4.73	0.91	1886
30	20	6.13	4.84	0.79	1722	5.88	4.64	0.79	1825	5.70	4.50	0.79	1866	5.50	4.35	0.79	1948
30	22	6.38	4.27	0.67	1784	6.15	4.12	0.67	1896	6.00	4.02	0.67	1948	5.75	3.85	0.67	2030
30	24	6.70	3.69	0.55	1866	6.45	3.55	0.55	1968	6.30	3.47	0.55	2030	6.10	3.36	0.55	2132
30	26	6.90	2.97	0.43	1968	6.70	2.88	0.43	2071	6.60	2.84	0.43	2132	6.40	2.75	0.43	2194
31	18	5.88	5.58	0.95	1640	5.63	5.34	0.95	1722	5.40	5.13	0.95	1804	5.20	4.94	0.95	1886
31	20	6.13	5.08	0.83	1722	5.88	4.88	0.83	1825	5.70	4.73	0.83	1866	5.50	4.57	0.83	1948
31	22	6.38	4.53	0.71	1784	6.15	4.37	0.71	1896	6.00	4.26	0.71	1948	5.75	4.08	0.71	2030
31	24	6.70	3.95	0.59	1866	6.45	3.81	0.59	1968	6.30	3.72	0.59	2030	6.10	3.60	0.59	2132
31	26	6.90	3.24	0.47	1968	6.70	3.15	0.47	2071	6.60	3.10	0.47	2132	6.40	3.01	0.47	2194
32	18	5.88	5.82	0.99	1640	5.63	5.57	0.99	1722	5.40	5.35	0.99	1804	5.20	5.15	0.99	1886
32	20	6.13	5.33	0.87	1722	5.88	5.11	0.87	1825	5.70	4.96	0.87	1866	5.50	4.79	0.87	1948
32	22	6.38	4.78	0.75	1784	6.15	4.61	0.75	1896	6.00	4.50	0.75	1948	5.75	4.31	0.75	2030
32	24	6.70	4.22	0.63	1866	6.45	4.06	0.63	1968	6.30	3.97	0.63	2030	6.10	3.84	0.63	2132
32	26	6.90	3.52	0.51	1968	6.70	3.42	0.51	2071	6.60	3.37	0.51	2132	6.40	3.26	0.51	2194

**NOTE** Q : Total capacity (kW) SHF : Sensible heat factor DB : Dry-bulb temperature  
 SHC : Sensible heat capacity (kW) INPUT : Total power input (W) WB : Wet-bulb temperature

**PERFORMANCE DATA COOL operation at Rated frequency**

**MUZ-HR50VF**

CAPACITY: 5.0 kW

SHF: 0.73

INPUT: 2050 W

INDOOR DB (°C)	INDOOR WB (°C)	OUTDOOR DB (°C)											
		35				40				46			
		Q	SHC	SHF	INPUT	Q	SHC	SHF	INPUT	Q	SHC	SHF	INPUT
21	18	4.90	2.70	0.55	2009	4.50	2.48	0.55	2132	4.15	2.28	0.55	2214
21	20	5.15	2.21	0.43	2091	4.80	2.06	0.43	2194	4.45	1.91	0.43	2317
22	18	4.90	2.89	0.59	2009	4.50	2.66	0.59	2132	4.15	2.45	0.59	2214
22	20	5.15	2.42	0.47	2091	4.80	2.26	0.47	2194	4.45	2.09	0.47	2317
22	22	5.45	1.91	0.35	2173	5.10	1.79	0.35	2296	4.75	1.66	0.35	2378
23	18	4.90	3.09	0.63	2009	4.50	2.84	0.63	2132	4.15	2.61	0.63	2214
23	20	5.15	2.63	0.51	2091	4.80	2.45	0.51	2194	4.45	2.27	0.51	2317
23	22	5.45	2.13	0.39	2173	5.10	1.99	0.39	2296	4.75	1.85	0.39	2378
24	18	4.90	3.28	0.67	2009	4.50	3.02	0.67	2132	4.15	2.78	0.67	2214
24	20	5.15	2.83	0.55	2091	4.80	2.64	0.55	2194	4.45	2.45	0.55	2317
24	22	5.45	2.34	0.43	2173	5.10	2.19	0.43	2296	4.75	2.04	0.43	2378
24	24	5.75	1.78	0.31	2255	5.40	1.67	0.31	2358	5.10	1.58	0.31	2460
25	18	4.90	3.48	0.71	2009	4.50	3.20	0.71	2132	4.15	2.95	0.71	2214
25	20	5.15	3.04	0.59	2091	4.80	2.83	0.59	2194	4.45	2.63	0.59	2317
25	22	5.45	2.56	0.47	2173	5.10	2.40	0.47	2296	4.75	2.23	0.47	2378
25	24	5.75	2.01	0.35	2255	5.40	1.89	0.35	2358	5.10	1.79	0.35	2460
26	18	4.90	3.68	0.75	2009	4.50	3.38	0.75	2132	4.15	3.11	0.75	2214
26	20	5.15	3.24	0.63	2091	4.80	3.02	0.63	2194	4.45	2.80	0.63	2317
26	22	5.45	2.78	0.51	2173	5.10	2.60	0.51	2296	4.75	2.42	0.51	2378
26	24	5.75	2.24	0.39	2255	5.40	2.11	0.39	2358	5.10	1.99	0.39	2460
26	26	6.05	1.63	0.27	2337	5.70	1.54	0.27	2440	5.35	1.44	0.27	2542
27	18	4.90	3.87	0.79	2009	4.50	3.56	0.79	2132	4.15	3.28	0.79	2214
27	20	5.15	3.45	0.67	2091	4.80	3.22	0.67	2194	4.45	2.98	0.67	2317
27	22	5.45	3.00	0.55	2173	5.10	2.81	0.55	2296	4.75	2.61	0.55	2378
27	24	5.75	2.47	0.43	2255	5.40	2.32	0.43	2358	5.10	2.19	0.43	2460
27	26	6.05	1.88	0.31	2337	5.70	1.77	0.31	2440	5.35	1.66	0.31	2542
28	18	4.90	4.07	0.83	2009	4.50	3.74	0.83	2132	4.15	3.44	0.83	2214
28	20	5.15	3.66	0.71	2091	4.80	3.41	0.71	2194	4.45	3.16	0.71	2317
28	22	5.45	3.22	0.59	2173	5.10	3.01	0.59	2296	4.75	2.80	0.59	2378
28	24	5.75	2.70	0.47	2255	5.40	2.54	0.47	2358	5.10	2.40	0.47	2460
28	26	6.05	2.12	0.35	2337	5.70	2.00	0.35	2440	5.35	1.87	0.35	2542
29	18	4.90	4.26	0.87	2009	4.50	3.92	0.87	2132	4.15	3.61	0.87	2214
29	20	5.15	3.86	0.75	2091	4.80	3.60	0.75	2194	4.45	3.34	0.75	2317
29	22	5.45	3.43	0.63	2173	5.10	3.21	0.63	2296	4.75	2.99	0.63	2378
29	24	5.75	2.93	0.51	2255	5.40	2.75	0.51	2358	5.10	2.60	0.51	2460
29	26	6.05	2.36	0.39	2337	5.70	2.22	0.39	2440	5.35	2.09	0.39	2542
30	18	4.90	4.46	0.91	2009	4.50	4.10	0.91	2132	4.15	3.78	0.91	2214
30	20	5.15	4.07	0.79	2091	4.80	3.79	0.79	2194	4.45	3.52	0.79	2317
30	22	5.45	3.65	0.67	2173	5.10	3.42	0.67	2296	4.75	3.18	0.67	2378
30	24	5.75	3.16	0.55	2255	5.40	2.97	0.55	2358	5.10	2.81	0.55	2460
30	26	6.05	2.60	0.43	2337	5.70	2.45	0.43	2440	5.35	2.30	0.43	2542
31	18	4.90	4.66	0.95	2009	4.50	4.28	0.95	2132	4.15	3.94	0.95	2214
31	20	5.15	4.27	0.83	2091	4.80	3.98	0.83	2194	4.45	3.69	0.83	2317
31	22	5.45	3.87	0.71	2173	5.10	3.62	0.71	2296	4.75	3.37	0.71	2378
31	24	5.75	3.39	0.59	2255	5.40	3.19	0.59	2358	5.10	3.01	0.59	2460
31	26	6.05	2.84	0.47	2337	5.70	2.68	0.47	2440	5.35	2.51	0.47	2542
32	18	4.90	4.85	0.99	2009	4.50	4.46	0.99	2132	4.15	4.11	0.99	2214
32	20	5.15	4.48	0.87	2091	4.80	4.18	0.87	2194	4.45	3.87	0.87	2317
32	22	5.45	4.09	0.75	2173	5.10	3.83	0.75	2296	4.75	3.56	0.75	2378
32	24	5.75	3.62	0.63	2255	5.40	3.40	0.63	2358	5.10	3.21	0.63	2460
32	26	6.05	3.09	0.51	2337	5.70	2.91	0.51	2440	5.35	2.73	0.51	2542

**NOTE** Q : Total capacity (kW) SHF : Sensible heat factor DB : Dry-bulb temperature  
 SHC : Sensible heat capacity (kW) INPUT : Total power input (W) WB : Wet-bulb temperature

**PERFORMANCE DATA COOL operation at Rated frequency**

**MUZ-HR60VF**

CAPACITY: 6.1 kW

SHF: 0.79

INPUT: 1810 W

INDOOR DB (°C)	INDOOR WB (°C)	OUTDOOR DB (°C)															
		21				25				27				30			
		Q	SHC	SHF	INPUT	Q	SHC	SHF	INPUT	Q	SHC	SHF	INPUT	Q	SHC	SHF	INPUT
21	18	7.17	4.37	0.61	1448	6.86	4.19	0.61	1520	6.59	4.02	0.61	1593	6.34	3.87	0.61	1665
21	20	7.47	3.66	0.49	1520	7.17	3.51	0.49	1611	6.95	3.41	0.49	1647	6.71	3.29	0.49	1720
22	18	7.17	4.66	0.65	1448	6.86	4.46	0.65	1520	6.59	4.28	0.65	1593	6.34	4.12	0.65	1665
22	20	7.47	3.96	0.53	1520	7.17	3.80	0.53	1611	6.95	3.69	0.53	1647	6.71	3.56	0.53	1720
22	22	7.78	3.19	0.41	1575	7.50	3.08	0.41	1674	7.32	3.00	0.41	1720	7.02	2.88	0.41	1792
23	18	7.17	4.95	0.69	1448	6.86	4.74	0.69	1520	6.59	4.55	0.69	1593	6.34	4.38	0.69	1665
23	20	7.47	4.26	0.57	1520	7.17	4.09	0.57	1611	6.95	3.96	0.57	1647	6.71	3.82	0.57	1720
23	22	7.78	3.50	0.45	1575	7.50	3.38	0.45	1674	7.32	3.29	0.45	1720	7.02	3.16	0.45	1792
24	18	7.17	5.23	0.73	1448	6.86	5.01	0.73	1520	6.59	4.81	0.73	1593	6.34	4.63	0.73	1665
24	20	7.47	4.56	0.61	1520	7.17	4.37	0.61	1611	6.95	4.24	0.61	1647	6.71	4.09	0.61	1720
24	22	7.78	3.81	0.49	1575	7.50	3.68	0.49	1674	7.32	3.59	0.49	1720	7.02	3.44	0.49	1792
24	24	8.17	3.02	0.37	1647	7.87	2.91	0.37	1738	7.69	2.84	0.37	1792	7.44	2.75	0.37	1882
25	18	7.17	5.52	0.77	1448	6.86	5.28	0.77	1520	6.59	5.07	0.77	1593	6.34	4.88	0.77	1665
25	20	7.47	4.86	0.65	1520	7.17	4.66	0.65	1611	6.95	4.52	0.65	1647	6.71	4.36	0.65	1720
25	22	7.78	4.12	0.53	1575	7.50	3.98	0.53	1674	7.32	3.88	0.53	1720	7.02	3.72	0.53	1792
25	24	8.17	3.35	0.41	1647	7.87	3.23	0.41	1738	7.69	3.15	0.41	1792	7.44	3.05	0.41	1882
26	18	7.17	5.81	0.81	1448	6.86	5.56	0.81	1520	6.59	5.34	0.81	1593	6.34	5.14	0.81	1665
26	20	7.47	5.16	0.69	1520	7.17	4.95	0.69	1611	6.95	4.80	0.69	1647	6.71	4.63	0.69	1720
26	22	7.78	4.43	0.57	1575	7.50	4.28	0.57	1674	7.32	4.17	0.57	1720	7.02	4.00	0.57	1792
26	24	8.17	3.68	0.45	1647	7.87	3.54	0.45	1738	7.69	3.46	0.45	1792	7.44	3.35	0.45	1882
26	26	8.42	2.78	0.33	1738	8.17	2.70	0.33	1828	8.05	2.66	0.33	1882	7.81	2.58	0.33	1937
27	18	7.17	6.09	0.85	1448	6.86	5.83	0.85	1520	6.59	5.60	0.85	1593	6.34	5.39	0.85	1665
27	20	7.47	5.45	0.73	1520	7.17	5.23	0.73	1611	6.95	5.08	0.73	1647	6.71	4.90	0.73	1720
27	22	7.78	4.74	0.61	1575	7.50	4.58	0.61	1674	7.32	4.47	0.61	1720	7.02	4.28	0.61	1792
27	24	8.17	4.01	0.49	1647	7.87	3.86	0.49	1738	7.69	3.77	0.49	1792	7.44	3.65	0.49	1882
27	26	8.42	3.11	0.37	1738	8.17	3.02	0.37	1828	8.05	2.98	0.37	1882	7.81	2.89	0.37	1937
28	18	7.17	6.38	0.89	1448	6.86	6.11	0.89	1520	6.59	5.86	0.89	1593	6.34	5.65	0.89	1665
28	20	7.47	5.75	0.77	1520	7.17	5.52	0.77	1611	6.95	5.35	0.77	1647	6.71	5.17	0.77	1720
28	22	7.78	5.06	0.65	1575	7.50	4.88	0.65	1674	7.32	4.76	0.65	1720	7.02	4.56	0.65	1792
28	24	8.17	4.33	0.53	1647	7.87	4.17	0.53	1738	7.69	4.07	0.53	1792	7.44	3.94	0.53	1882
28	26	8.42	3.45	0.41	1738	8.17	3.35	0.41	1828	8.05	3.30	0.41	1882	7.81	3.20	0.41	1937
29	18	7.17	6.67	0.93	1448	6.86	6.38	0.93	1520	6.59	6.13	0.93	1593	6.34	5.90	0.93	1665
29	20	7.47	6.05	0.81	1520	7.17	5.81	0.81	1611	6.95	5.63	0.81	1647	6.71	5.44	0.81	1720
29	22	7.78	5.37	0.69	1575	7.50	5.18	0.69	1674	7.32	5.05	0.69	1720	7.02	4.84	0.69	1792
29	24	8.17	4.66	0.57	1647	7.87	4.49	0.57	1738	7.69	4.38	0.57	1792	7.44	4.24	0.57	1882
29	26	8.42	3.79	0.45	1738	8.17	3.68	0.45	1828	8.05	3.62	0.45	1882	7.81	3.51	0.45	1937
30	18	7.17	6.95	0.97	1448	6.86	6.66	0.97	1520	6.59	6.39	0.97	1593	6.34	6.15	0.97	1665
30	20	7.47	6.35	0.85	1520	7.17	6.09	0.85	1611	6.95	5.91	0.85	1647	6.71	5.70	0.85	1720
30	22	7.78	5.68	0.73	1575	7.50	5.48	0.73	1674	7.32	5.34	0.73	1720	7.02	5.12	0.73	1792
30	24	8.17	4.99	0.61	1647	7.87	4.80	0.61	1738	7.69	4.69	0.61	1792	7.44	4.54	0.61	1882
30	26	8.42	4.12	0.49	1738	8.17	4.01	0.49	1828	8.05	3.95	0.49	1882	7.81	3.83	0.49	1937
31	18	7.17	7.17	1.00	1448	6.86	6.86	1.00	1520	6.59	6.59	1.00	1593	6.34	6.34	1.00	1665
31	20	7.47	6.65	0.89	1520	7.17	6.38	0.89	1611	6.95	6.19	0.89	1647	6.71	5.97	0.89	1720
31	22	7.78	5.99	0.77	1575	7.50	5.78	0.77	1674	7.32	5.64	0.77	1720	7.02	5.40	0.77	1792
31	24	8.17	5.31	0.65	1647	7.87	5.11	0.65	1738	7.69	5.00	0.65	1792	7.44	4.84	0.65	1882
31	26	8.42	4.46	0.53	1738	8.17	4.33	0.53	1828	8.05	4.27	0.53	1882	7.81	4.14	0.53	1937
32	18	7.17	7.17	1.00	1448	6.86	6.86	1.00	1520	6.59	6.59	1.00	1593	6.34	6.34	1.00	1665
32	20	7.47	6.95	0.93	1520	7.17	6.67	0.93	1611	6.95	6.47	0.93	1647	6.71	6.24	0.93	1720
32	22	7.78	6.30	0.81	1575	7.50	6.08	0.81	1674	7.32	5.93	0.81	1720	7.02	5.68	0.81	1792
32	24	8.17	5.64	0.69	1647	7.87	5.43	0.69	1738	7.69	5.30	0.69	1792	7.44	5.13	0.69	1882
32	26	8.42	4.80	0.57	1738	8.17	4.66	0.57	1828	8.05	4.59	0.57	1882	7.81	4.45	0.57	1937

**NOTE** Q : Total capacity (kW) SHF : Sensible heat factor DB : Dry-bulb temperature  
 SHC : Sensible heat capacity (kW) INPUT : Total power input (W) WB : Wet-bulb temperature

**PERFORMANCE DATA COOL operation at Rated frequency  
MUZ-HR60VF**

CAPACITY: 6.1 kW      SHF: 0.79      INPUT: 1810 W

INDOOR DB (°C)	INDOOR WB (°C)	OUTDOOR DB (°C)											
		35				40				46			
		Q	SHC	SHF	INPUT	Q	SHC	SHF	INPUT	Q	SHC	SHF	INPUT
21	18	5.98	3.65	0.61	1774	5.49	3.35	0.61	1882	5.06	3.09	0.61	1955
21	20	6.28	3.08	0.49	1846	5.86	2.87	0.49	1937	5.43	2.66	0.49	2045
22	18	5.98	3.89	0.65	1774	5.49	3.57	0.65	1882	5.06	3.29	0.65	1955
22	20	6.28	3.33	0.53	1846	5.86	3.10	0.53	1937	5.43	2.88	0.53	2045
22	22	6.65	2.73	0.41	1919	6.22	2.55	0.41	2027	5.80	2.38	0.41	2100
23	18	5.98	4.12	0.69	1774	5.49	3.79	0.69	1882	5.06	3.49	0.69	1955
23	20	6.28	3.58	0.57	1846	5.86	3.34	0.57	1937	5.43	3.09	0.57	2045
23	22	6.65	2.99	0.45	1919	6.22	2.80	0.45	2027	5.80	2.61	0.45	2100
24	18	5.98	4.36	0.73	1774	5.49	4.01	0.73	1882	5.06	3.70	0.73	1955
24	20	6.28	3.83	0.61	1846	5.86	3.57	0.61	1937	5.43	3.31	0.61	2045
24	22	6.65	3.26	0.49	1919	6.22	3.05	0.49	2027	5.80	2.84	0.49	2100
24	24	7.02	2.60	0.37	1991	6.59	2.44	0.37	2082	6.22	2.30	0.37	2172
25	18	5.98	4.60	0.77	1774	5.49	4.23	0.77	1882	5.06	3.90	0.77	1955
25	20	6.28	4.08	0.65	1846	5.86	3.81	0.65	1937	5.43	3.53	0.65	2045
25	22	6.65	3.52	0.53	1919	6.22	3.30	0.53	2027	5.80	3.07	0.53	2100
25	24	7.02	2.88	0.41	1991	6.59	2.70	0.41	2082	6.22	2.55	0.41	2172
26	18	5.98	4.84	0.81	1774	5.49	4.45	0.81	1882	5.06	4.10	0.81	1955
26	20	6.28	4.34	0.69	1846	5.86	4.04	0.69	1937	5.43	3.75	0.69	2045
26	22	6.65	3.79	0.57	1919	6.22	3.55	0.57	2027	5.80	3.30	0.57	2100
26	24	7.02	3.16	0.45	1991	6.59	2.96	0.45	2082	6.22	2.80	0.45	2172
26	26	7.38	2.44	0.33	2063	6.95	2.29	0.33	2154	6.53	2.15	0.33	2244
27	18	5.98	5.08	0.85	1774	5.49	4.67	0.85	1882	5.06	4.30	0.85	1955
27	20	6.28	4.59	0.73	1846	5.86	4.27	0.73	1937	5.43	3.96	0.73	2045
27	22	6.65	4.06	0.61	1919	6.22	3.80	0.61	2027	5.80	3.53	0.61	2100
27	24	7.02	3.44	0.49	1991	6.59	3.23	0.49	2082	6.22	3.05	0.49	2172
27	26	7.38	2.73	0.37	2063	6.95	2.57	0.37	2154	6.53	2.41	0.37	2244
28	18	5.98	5.32	0.89	1774	5.49	4.89	0.89	1882	5.06	4.51	0.89	1955
28	20	6.28	4.84	0.77	1846	5.86	4.51	0.77	1937	5.43	4.18	0.77	2045
28	22	6.65	4.32	0.65	1919	6.22	4.04	0.65	2027	5.80	3.77	0.65	2100
28	24	7.02	3.72	0.53	1991	6.59	3.49	0.53	2082	6.22	3.30	0.53	2172
28	26	7.38	3.03	0.41	2063	6.95	2.85	0.41	2154	6.53	2.68	0.41	2244
29	18	5.98	5.56	0.93	1774	5.49	5.11	0.93	1882	5.06	4.71	0.93	1955
29	20	6.28	5.09	0.81	1846	5.86	4.74	0.81	1937	5.43	4.40	0.81	2045
29	22	6.65	4.59	0.69	1919	6.22	4.29	0.69	2027	5.80	4.00	0.69	2100
29	24	7.02	4.00	0.57	1991	6.59	3.76	0.57	2082	6.22	3.55	0.57	2172
29	26	7.38	3.32	0.45	2063	6.95	3.13	0.45	2154	6.53	2.94	0.45	2244
30	18	5.98	5.80	0.97	1774	5.49	5.33	0.97	1882	5.06	4.91	0.97	1955
30	20	6.28	5.34	0.85	1846	5.86	4.98	0.85	1937	5.43	4.61	0.85	2045
30	22	6.65	4.85	0.73	1919	6.22	4.54	0.73	2027	5.80	4.23	0.73	2100
30	24	7.02	4.28	0.61	1991	6.59	4.02	0.61	2082	6.22	3.80	0.61	2172
30	26	7.38	3.62	0.49	2063	6.95	3.41	0.49	2154	6.53	3.20	0.49	2244
31	18	5.98	5.98	1.00	1774	5.49	5.49	1.00	1882	5.06	5.06	1.00	1955
31	20	6.28	5.59	0.89	1846	5.86	5.21	0.89	1937	5.43	4.83	0.89	2045
31	22	6.65	5.12	0.77	1919	6.22	4.79	0.77	2027	5.80	4.46	0.77	2100
31	24	7.02	4.56	0.65	1991	6.59	4.28	0.65	2082	6.22	4.04	0.65	2172
31	26	7.38	3.91	0.53	2063	6.95	3.69	0.53	2154	6.53	3.46	0.53	2244
32	18	5.98	5.98	1.00	1774	5.49	5.49	1.00	1882	5.06	5.06	1.00	1955
32	20	6.28	5.84	0.93	1846	5.86	5.45	0.93	1937	5.43	5.05	0.93	2045
32	22	6.65	5.39	0.81	1919	6.22	5.04	0.81	2027	5.80	4.69	0.81	2100
32	24	7.02	4.84	0.69	1991	6.59	4.55	0.69	2082	6.22	4.29	0.69	2172
32	26	7.38	4.21	0.57	2063	6.95	3.96	0.57	2154	6.53	3.72	0.57	2244

**NOTE**    Q : Total capacity (kW)      SHF : Sensible heat factor      DB : Dry-bulb temperature  
           SHC : Sensible heat capacity (kW)    INPUT : Total power input (W)    WB : Wet-bulb temperature

**PERFORMANCE DATA COOL operation at Rated frequency**  
**MUZ-HR71VF**

CAPACITY: 7.1 kW SHF: 0.74 INPUT: 2330 W

INDOOR DB (°C)	INDOOR WB (°C)	OUTDOOR DB (°C)															
		21				25				27				30			
		Q	SHC	SHF	INPUT	Q	SHC	SHF	INPUT	Q	SHC	SHF	INPUT	Q	SHC	SHF	INPUT
21	18	8.34	4.67	0.56	1864	7.99	4.47	0.56	1957	7.67	4.29	0.56	2050	7.38	4.14	0.56	2144
21	20	8.70	3.83	0.44	1957	8.34	3.67	0.44	2074	8.09	3.56	0.44	2120	7.81	3.44	0.44	2214
22	18	8.34	5.01	0.60	1864	7.99	4.79	0.60	1957	7.67	4.60	0.60	2050	7.38	4.43	0.60	2144
22	20	8.70	4.17	0.48	1957	8.34	4.00	0.48	2074	8.09	3.89	0.48	2120	7.81	3.75	0.48	2214
22	22	9.05	3.26	0.36	2027	8.73	3.14	0.36	2155	8.52	3.07	0.36	2214	8.17	2.94	0.36	2307
23	18	8.34	5.34	0.64	1864	7.99	5.11	0.64	1957	7.67	4.91	0.64	2050	7.38	4.73	0.64	2144
23	20	8.70	4.52	0.52	1957	8.34	4.34	0.52	2074	8.09	4.21	0.52	2120	7.81	4.06	0.52	2214
23	22	9.05	3.62	0.40	2027	8.73	3.49	0.40	2155	8.52	3.41	0.40	2214	8.17	3.27	0.40	2307
24	18	8.34	5.67	0.68	1864	7.99	5.43	0.68	1957	7.67	5.21	0.68	2050	7.38	5.02	0.68	2144
24	20	8.70	4.87	0.56	1957	8.34	4.67	0.56	2074	8.09	4.53	0.56	2120	7.81	4.37	0.56	2214
24	22	9.05	3.98	0.44	2027	8.73	3.84	0.44	2155	8.52	3.75	0.44	2214	8.17	3.59	0.44	2307
24	24	9.51	3.04	0.32	2120	9.16	2.93	0.32	2237	8.95	2.86	0.32	2307	8.66	2.77	0.32	2423
25	18	8.34	6.01	0.72	1864	7.99	5.75	0.72	1957	7.67	5.52	0.72	2050	7.38	5.32	0.72	2144
25	20	8.70	5.22	0.60	1957	8.34	5.01	0.60	2074	8.09	4.86	0.60	2120	7.81	4.69	0.60	2214
25	22	9.05	4.35	0.48	2027	8.73	4.19	0.48	2155	8.52	4.09	0.48	2214	8.17	3.92	0.48	2307
25	24	9.51	3.43	0.36	2120	9.16	3.30	0.36	2237	8.95	3.22	0.36	2307	8.66	3.12	0.36	2423
26	18	8.34	6.34	0.76	1864	7.99	6.07	0.76	1957	7.67	5.83	0.76	2050	7.38	5.61	0.76	2144
26	20	8.70	5.57	0.64	1957	8.34	5.34	0.64	2074	8.09	5.18	0.64	2120	7.81	5.00	0.64	2214
26	22	9.05	4.71	0.52	2027	8.73	4.54	0.52	2155	8.52	4.43	0.52	2214	8.17	4.25	0.52	2307
26	24	9.51	3.81	0.40	2120	9.16	3.66	0.40	2237	8.95	3.58	0.40	2307	8.66	3.46	0.40	2423
26	26	9.80	2.74	0.28	2237	9.51	2.66	0.28	2353	9.37	2.62	0.28	2423	9.09	2.54	0.28	2493
27	18	8.34	6.67	0.80	1864	7.99	6.39	0.80	1957	7.67	6.13	0.80	2050	7.38	5.91	0.80	2144
27	20	8.70	5.91	0.68	1957	8.34	5.67	0.68	2074	8.09	5.50	0.68	2120	7.81	5.31	0.68	2214
27	22	9.05	5.07	0.56	2027	8.73	4.89	0.56	2155	8.52	4.77	0.56	2214	8.17	4.57	0.56	2307
27	24	9.51	4.19	0.44	2120	9.16	4.03	0.44	2237	8.95	3.94	0.44	2307	8.66	3.81	0.44	2423
27	26	9.80	3.14	0.32	2237	9.51	3.04	0.32	2353	9.37	3.00	0.32	2423	9.09	2.91	0.32	2493
28	18	8.34	7.01	0.84	1864	7.99	6.71	0.84	1957	7.67	6.44	0.84	2050	7.38	6.20	0.84	2144
28	20	8.70	6.26	0.72	1957	8.34	6.01	0.72	2074	8.09	5.83	0.72	2120	7.81	5.62	0.72	2214
28	22	9.05	5.43	0.60	2027	8.73	5.24	0.60	2155	8.52	5.11	0.60	2214	8.17	4.90	0.60	2307
28	24	9.51	4.57	0.48	2120	9.16	4.40	0.48	2237	8.95	4.29	0.48	2307	8.66	4.16	0.48	2423
28	26	9.80	3.53	0.36	2237	9.51	3.43	0.36	2353	9.37	3.37	0.36	2423	9.09	3.27	0.36	2493
29	18	8.34	7.34	0.88	1864	7.99	7.03	0.88	1957	7.67	6.75	0.88	2050	7.38	6.50	0.88	2144
29	20	8.70	6.61	0.76	1957	8.34	6.34	0.76	2074	8.09	6.15	0.76	2120	7.81	5.94	0.76	2214
29	22	9.05	5.79	0.64	2027	8.73	5.59	0.64	2155	8.52	5.45	0.64	2214	8.17	5.23	0.64	2307
29	24	9.51	4.95	0.52	2120	9.16	4.76	0.52	2237	8.95	4.65	0.52	2307	8.66	4.50	0.52	2423
29	26	9.80	3.92	0.40	2237	9.51	3.81	0.40	2353	9.37	3.75	0.40	2423	9.09	3.64	0.40	2493
30	18	8.34	7.68	0.92	1864	7.99	7.35	0.92	1957	7.67	7.05	0.92	2050	7.38	6.79	0.92	2144
30	20	8.70	6.96	0.80	1957	8.34	6.67	0.80	2074	8.09	6.48	0.80	2120	7.81	6.25	0.80	2214
30	22	9.05	6.16	0.68	2027	8.73	5.94	0.68	2155	8.52	5.79	0.68	2214	8.17	5.55	0.68	2307
30	24	9.51	5.33	0.56	2120	9.16	5.13	0.56	2237	8.95	5.01	0.56	2307	8.66	4.85	0.56	2423
30	26	9.80	4.31	0.44	2237	9.51	4.19	0.44	2353	9.37	4.12	0.44	2423	9.09	4.00	0.44	2493
31	18	8.34	8.01	0.96	1864	7.99	7.67	0.96	1957	7.67	7.36	0.96	2050	7.38	7.09	0.96	2144
31	20	8.70	7.31	0.84	1957	8.34	7.01	0.84	2074	8.09	6.80	0.84	2120	7.81	6.56	0.84	2214
31	22	9.05	6.52	0.72	2027	8.73	6.29	0.72	2155	8.52	6.13	0.72	2214	8.17	5.88	0.72	2307
31	24	9.51	5.71	0.60	2120	9.16	5.50	0.60	2237	8.95	5.37	0.60	2307	8.66	5.20	0.60	2423
31	26	9.80	4.70	0.48	2237	9.51	4.57	0.48	2353	9.37	4.50	0.48	2423	9.09	4.36	0.48	2493
32	18	8.34	8.34	1.00	1864	7.99	7.99	1.00	1957	7.67	7.67	1.00	2050	7.38	7.38	1.00	2144
32	20	8.70	7.65	0.88	1957	8.34	7.34	0.88	2074	8.09	7.12	0.88	2120	7.81	6.87	0.88	2214
32	22	9.05	6.88	0.76	2027	8.73	6.64	0.76	2155	8.52	6.48	0.76	2214	8.17	6.21	0.76	2307
32	24	9.51	6.09	0.64	2120	9.16	5.86	0.64	2237	8.95	5.73	0.64	2307	8.66	5.54	0.64	2423
32	26	9.80	5.09	0.52	2237	9.51	4.95	0.52	2353	9.37	4.87	0.52	2423	9.09	4.73	0.52	2493

**NOTE** Q : Total capacity (kW) SHF : Sensible heat factor DB : Dry-bulb temperature  
 SHC : Sensible heat capacity (kW) INPUT : Total power input (W) WB : Wet-bulb temperature



**PERFORMANCE DATA COOL operation at Rated frequency  
MUZ-HR71VF**

CAPACITY: 7.1 kW SHF: 0.74 INPUT: 2330 W

INDOOR DB (°C)	INDOOR WB (°C)	OUTDOOR DB (°C)											
		35				40				46			
		Q	SHC	SHF	INPUT	Q	SHC	SHF	INPUT	Q	SHC	SHF	INPUT
21	18	6.96	3.90	0.56	2283	6.39	3.58	0.56	2423	5.89	3.30	0.56	2516
21	20	7.31	3.22	0.44	2377	6.82	3.00	0.44	2493	6.32	2.78	0.44	2633
22	18	6.96	4.17	0.60	2283	6.39	3.83	0.60	2423	5.89	3.54	0.60	2516
22	20	7.31	3.51	0.48	2377	6.82	3.27	0.48	2493	6.32	3.03	0.48	2633
22	22	7.74	2.79	0.36	2470	7.24	2.61	0.36	2610	6.75	2.43	0.36	2703
23	18	6.96	4.45	0.64	2283	6.39	4.09	0.64	2423	5.89	3.77	0.64	2516
23	20	7.31	3.80	0.52	2377	6.82	3.54	0.52	2493	6.32	3.29	0.52	2633
23	22	7.74	3.10	0.40	2470	7.24	2.90	0.40	2610	6.75	2.70	0.40	2703
24	18	6.96	4.73	0.68	2283	6.39	4.35	0.68	2423	5.89	4.01	0.68	2516
24	20	7.31	4.10	0.56	2377	6.82	3.82	0.56	2493	6.32	3.54	0.56	2633
24	22	7.74	3.41	0.44	2470	7.24	3.19	0.44	2610	6.75	2.97	0.44	2703
24	24	8.17	2.61	0.32	2563	7.67	2.45	0.32	2680	7.24	2.32	0.32	2796
25	18	6.96	5.01	0.72	2283	6.39	4.60	0.72	2423	5.89	4.24	0.72	2516
25	20	7.31	4.39	0.60	2377	6.82	4.09	0.60	2493	6.32	3.79	0.60	2633
25	22	7.74	3.71	0.48	2470	7.24	3.48	0.48	2610	6.75	3.24	0.48	2703
25	24	8.17	2.94	0.36	2563	7.67	2.76	0.36	2680	7.24	2.61	0.36	2796
26	18	6.96	5.29	0.76	2283	6.39	4.86	0.76	2423	5.89	4.48	0.76	2516
26	20	7.31	4.68	0.64	2377	6.82	4.36	0.64	2493	6.32	4.04	0.64	2633
26	22	7.74	4.02	0.52	2470	7.24	3.77	0.52	2610	6.75	3.51	0.52	2703
26	24	8.17	3.27	0.40	2563	7.67	3.07	0.40	2680	7.24	2.90	0.40	2796
26	26	8.59	2.41	0.28	2656	8.09	2.27	0.28	2773	7.60	2.13	0.28	2889
27	18	6.96	5.57	0.80	2283	6.39	5.11	0.80	2423	5.89	4.71	0.80	2516
27	20	7.31	4.97	0.68	2377	6.82	4.63	0.68	2493	6.32	4.30	0.68	2633
27	22	7.74	4.33	0.56	2470	7.24	4.06	0.56	2610	6.75	3.78	0.56	2703
27	24	8.17	3.59	0.44	2563	7.67	3.37	0.44	2680	7.24	3.19	0.44	2796
27	26	8.59	2.75	0.32	2656	8.09	2.59	0.32	2773	7.60	2.43	0.32	2889
28	18	6.96	5.84	0.84	2283	6.39	5.37	0.84	2423	5.89	4.95	0.84	2516
28	20	7.31	5.27	0.72	2377	6.82	4.91	0.72	2493	6.32	4.55	0.72	2633
28	22	7.74	4.64	0.60	2470	7.24	4.35	0.60	2610	6.75	4.05	0.60	2703
28	24	8.17	3.92	0.48	2563	7.67	3.68	0.48	2680	7.24	3.48	0.48	2796
28	26	8.59	3.09	0.36	2656	8.09	2.91	0.36	2773	7.60	2.73	0.36	2889
29	18	6.96	6.12	0.88	2283	6.39	5.62	0.88	2423	5.89	5.19	0.88	2516
29	20	7.31	5.56	0.76	2377	6.82	5.18	0.76	2493	6.32	4.80	0.76	2633
29	22	7.74	4.95	0.64	2470	7.24	4.63	0.64	2610	6.75	4.32	0.64	2703
29	24	8.17	4.25	0.52	2563	7.67	3.99	0.52	2680	7.24	3.77	0.52	2796
29	26	8.59	3.44	0.40	2656	8.09	3.24	0.40	2773	7.60	3.04	0.40	2889
30	18	6.96	6.40	0.92	2283	6.39	5.88	0.92	2423	5.89	5.42	0.92	2516
30	20	7.31	5.85	0.80	2377	6.82	5.45	0.80	2493	6.32	5.06	0.80	2633
30	22	7.74	5.26	0.68	2470	7.24	4.92	0.68	2610	6.75	4.59	0.68	2703
30	24	8.17	4.57	0.56	2563	7.67	4.29	0.56	2680	7.24	4.06	0.56	2796
30	26	8.59	3.78	0.44	2656	8.09	3.56	0.44	2773	7.60	3.34	0.44	2889
31	18	6.96	6.68	0.96	2283	6.39	6.13	0.96	2423	5.89	5.66	0.96	2516
31	20	7.31	6.14	0.84	2377	6.82	5.73	0.84	2493	6.32	5.31	0.84	2633
31	22	7.74	5.57	0.72	2470	7.24	5.21	0.72	2610	6.75	4.86	0.72	2703
31	24	8.17	4.90	0.60	2563	7.67	4.60	0.60	2680	7.24	4.35	0.60	2796
31	26	8.59	4.12	0.48	2656	8.09	3.89	0.48	2773	7.60	3.65	0.48	2889
32	18	6.96	6.96	1.00	2283	6.39	6.39	1.00	2423	5.89	5.89	1.00	2516
32	20	7.31	6.44	0.88	2377	6.82	6.00	0.88	2493	6.32	5.56	0.88	2633
32	22	7.74	5.88	0.76	2470	7.24	5.50	0.76	2610	6.75	5.13	0.76	2703
32	24	8.17	5.23	0.64	2563	7.67	4.91	0.64	2680	7.24	4.63	0.64	2796
32	26	8.59	4.47	0.52	2656	8.09	4.21	0.52	2773	7.60	3.95	0.52	2889

**NOTE** Q : Total capacity (kW) SHF : Sensible heat factor DB : Dry-bulb temperature  
SHC : Sensible heat capacity (kW) INPUT : Total power input (W) WB : Wet-bulb temperature

**PERFORMANCE DATA HEAT operation at Rated frequency**

**MUZ-HR25VF**

CAPACITY: 3.15 kW INPUT: 850W

INDOOR DB (°C)	OUTDOOR WB (°C)													
	-10		-5		0		5		10		15		20	
	Q	INPUT	Q	INPUT	Q	INPUT	Q	INPUT	Q	INPUT	Q	INPUT	Q	INPUT
15	1.98	553	2.39	663	2.80	748	3.21	808	3.62	859	4.00	884	4.41	901
21	1.89	595	2.27	706	2.68	782	3.06	842	3.47	884	3.84	910	4.24	944
26	1.70	638	2.11	748	2.49	825	2.90	884	3.31	927	3.69	952	4.10	978

**MUZ-HR35VF**

CAPACITY: 3.60kW INPUT: 975 W

INDOOR DB (°C)	OUTDOOR WB (°C)													
	-10		-5		0		5		10		15		20	
	Q	INPUT	Q	INPUT	Q	INPUT	Q	INPUT	Q	INPUT	Q	INPUT	Q	INPUT
15	2.27	634	2.74	761	3.20	858	3.67	926	4.14	985	4.57	1014	5.04	1034
21	2.16	683	2.59	809	3.06	897	3.49	965	3.96	1014	4.39	1043	4.84	1082
26	1.94	731	2.41	858	2.84	946	3.31	1014	3.78	1063	4.21	1092	4.68	1121

**MUZ-HR42VF**

CAPACITY: 4.70 kW INPUT: 1300 W

INDOOR DB (°C)	OUTDOOR WB (°C)													
	-10		-5		0		5		10		15		20	
	Q	INPUT	Q	INPUT	Q	INPUT	Q	INPUT	Q	INPUT	Q	INPUT	Q	INPUT
15	2.96	845	3.57	1014	4.18	1144	4.79	1235	5.41	1313	5.97	1352	6.58	1378
21	2.82	910	3.38	1079	4.00	1196	4.56	1287	5.17	1352	5.73	1391	6.32	1443
26	2.54	975	3.15	1144	3.71	1261	4.32	1352	4.94	1417	5.50	1456	6.11	1495

**MUZ-HR50VF**

CAPACITY: 5.40 kW INPUT: 1550 W

INDOOR DB (°C)	OUTDOOR WB (°C)													
	-10		-5		0		5		10		15		20	
	Q	INPUT	Q	INPUT	Q	INPUT	Q	INPUT	Q	INPUT	Q	INPUT	Q	INPUT
15	3.40	1008	4.10	1209	4.81	1364	5.51	1473	6.21	1566	6.86	1612	7.56	1643
21	3.24	1085	3.89	1287	4.59	1426	5.24	1535	5.94	1612	6.59	1659	7.26	1721
26	2.92	1163	3.62	1364	4.27	1504	4.97	1612	5.67	1690	6.32	1736	7.02	1783

**MUZ-HR60VF**

CAPACITY: 6.8 kW INPUT: 1810 W

INDOOR DB (°C)	OUTDOOR WB (°C)													
	-10		-5		0		5		10		15		20	
	Q	INPUT	Q	INPUT	Q	INPUT	Q	INPUT	Q	INPUT	Q	INPUT	Q	INPUT
15	4.28	1177	5.17	1412	6.05	1593	6.94	1720	7.82	1828	8.64	1882	9.52	1919
21	4.08	1267	4.90	1502	5.78	1665	6.60	1792	7.48	1882	8.30	1937	9.15	2009
26	3.67	1358	4.56	1593	5.37	1756	6.26	1882	7.14	1973	7.96	2027	8.84	2082

**MUZ-HR71VF**

CAPACITY: 8.1 kW INPUT: 2440 W

INDOOR DB (°C)	OUTDOOR WB (°C)													
	-10		-5		0		5		10		15		20	
	Q	INPUT	Q	INPUT	Q	INPUT	Q	INPUT	Q	INPUT	Q	INPUT	Q	INPUT
15	5.10	1586	6.16	1903	7.21	2147	8.26	2318	9.32	2464	10.29	2538	11.34	2586
21	4.86	1708	5.83	2025	6.89	2245	7.86	2416	8.91	2538	9.88	2611	10.89	2708
26	4.37	1830	5.43	2147	6.40	2367	7.45	2538	8.51	2660	9.48	2733	10.53	2806

**NOTE:** Q: Total capacity (kW) INPUT : Total power input (W) DB: Dry-bulb temperature WB: Wet-bulb temperature

MUZ-HR25VF MUZ-HR35VF MUZ-HR42VF MUZ-HR50VF MUZ-HR60VF MUZ-HR71VF

10-1. OUTDOOR FAN MOTOR CONTROL

The fan motor turns ON/OFF, interlocking with the compressor.

[ON] The fan motor turns ON 5 seconds before the compressor starts up.

[OFF] The fan motor turns OFF 15 seconds after the compressor has stopped running.

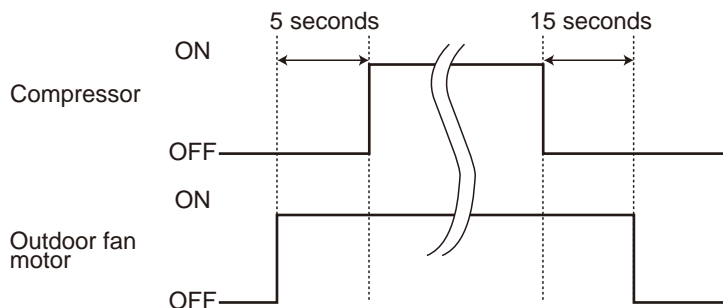

10-2. R.V. COIL CONTROL

Heating . . . . . ON

Cooling . . . . . OFF

Dry . . . . . OFF

**NOTE:** The 4-way valve reverses for 5 seconds right before startup of the compressor.

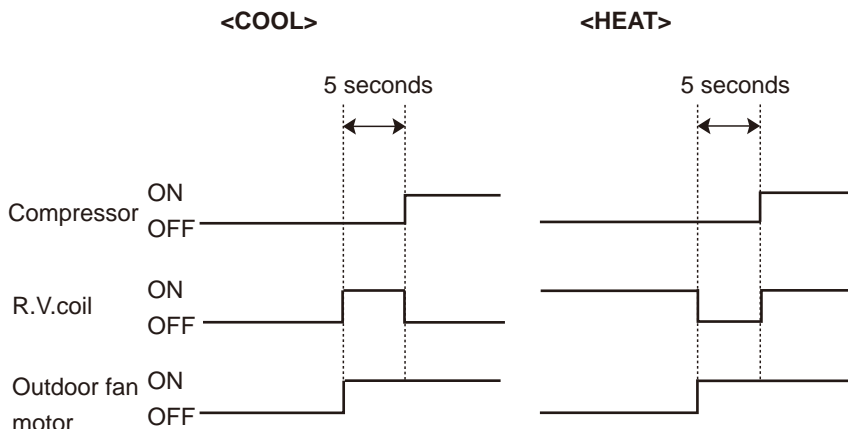

10-3. RELATION BETWEEN MAIN SENSOR AND ACTUATOR

Sensor	Purpose	Actuator					
		Compressor	LEV	Outdoor fan motor	R.V. coil	Indoor fan motor	Defrost heater
Discharge temperature thermistor	Protection	○	○				
Indoor coil temperature thermistor	Cooling: Coil frost prevention	○					
	Heating: High pressure protection	○	○				
Defrost thermistor	Heating: Defrosting	○	○	○	○	○	
Fin temperature thermistor	Protection	○		○			
Ambient temperature thermistor	Cooling: Low ambient temperature operation	○	○	○			
	Heating: Defrosting (Heater)						○
Outdoor heat exchanger temperature thermistor	Cooling: Low ambient temperature operation	○	○	○			
	Cooling: High pressure protection	○	○	○			

## MUZ-HR25VF MUZ-HR35VF MUZ-HR42VF MUZ-HR50VF MUZ-HR60VF MUZ-HR71VF

### 11-1. CHANGE IN DEFROST SETTING

#### Changing defrost finish temperature

<JS> To change the defrost finish temperature, cut/solder the JS wire of the outdoor inverter P.C. board.  
(Refer to 12-6-1.)

Jumper wire		Defrost finish temperature (°C)
JS	Soldered (Initial setting)	5
	None (Cut)	10

### 11-2. PRE-HEAT CONTROL SETTING

#### PRE-HEAT CONTROL

When moisture gets into the refrigerant cycle, it may interfere the startup of the compressor at low outside temperature. The pre-heat control prevents this interference. The pre-heat control turns ON when the discharge temperature thermistor is 20°C or below. When the pre-heat control turns ON, the compressor is energized. (About 50 W)

#### Pre-heat control setting

<JK>

ON: To activate the pre-heat control, cut the JK wire of the inverter P.C. board.

OFF: To deactivate the pre-heat control, solder the JK wire of the inverter P.C. board.

(Refer to 12-6.1)

**NOTE:** When the inverter P.C. board is replaced, check the jumper wires, and cut/solder them if necessary.

## MUZ-HR25VF MUZ-HR35VF MUZ-HR42VF MUZ-HR50VF MUZ-HR60VF MUZ-HR71VF

### 12-1. CAUTIONS ON TROUBLESHOOTING

#### 1. Before troubleshooting, check the following

- 1) Check the power supply voltage.
- 2) Check the indoor/outdoor connecting wire for miswiring.

#### 2. Take care of the following during servicing

- 1) Before servicing the air conditioner, be sure to turn OFF the main unit first with the remote controller, and then after confirming the horizontal vane is closed, turn OFF the breaker and/or disconnect the power plug.
- 2) Be sure to turn OFF the power supply before removing the front panel, the cabinet, the top panel, and the electronic control P.C. board.
- 3) When removing the electrical parts, be careful of the residual voltage of smoothing capacitor.
- 4) When removing the electronic control P.C. board, hold the edge of the board with care NOT to apply stress on the components.
- 5) When connecting or disconnecting the connectors, hold the connector housing. DO NOT pull the lead wires.

<Incorrect>



Lead wiring

<Correct>



Connector housing

#### 3. Troubleshooting procedure

- 1) Check if the OPERATION INDICATOR lamp on the indoor unit is blinking on and off to indicate an abnormality.  
To make sure, check how many times the OPERATION INDICATOR lamp is blinking on and off before starting service work.
- 2) Before servicing, check that the connector and terminal are connected properly.
- 3) When the electronic control P.C. board seems to be defective, check the copper foil pattern for disconnection and the components for bursting and discoloration.
- 4) Refer to 12-2 and 12-3.

## 12-2. FAILURE MODE RECALL FUNCTION

Outline of the function

This air conditioner can memorize the abnormal condition which has occurred once.

Even though LED indication listed on the troubleshooting check table (12-3.) disappears, the memorized failure details can be recalled.

### 1. Flow chart of failure mode recall function for the indoor/outdoor unit

Operational procedure

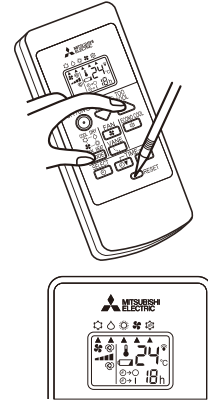
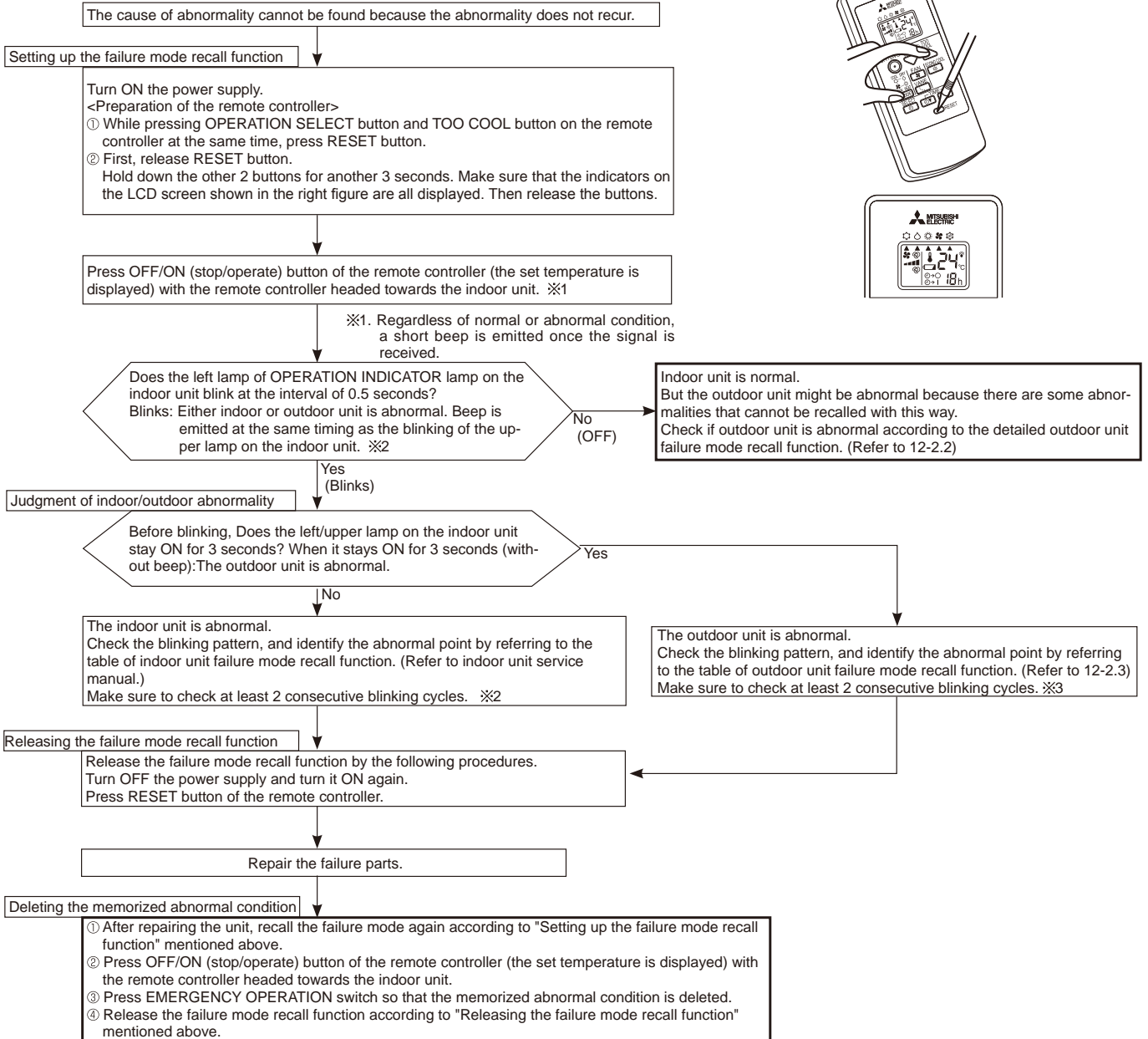

**NOTE:** 1. Make sure to release the failure mode recall function after it is set up, otherwise the unit cannot operate properly.  
2. If the abnormal condition is not deleted from the memory, the last abnormal condition is kept memorized.

※2. Blinking pattern when the indoor unit is abnormal:

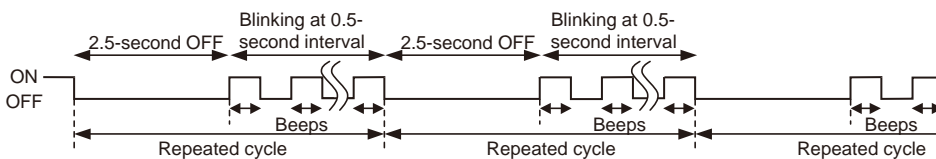

※3. Blinking pattern when the outdoor unit is abnormal:

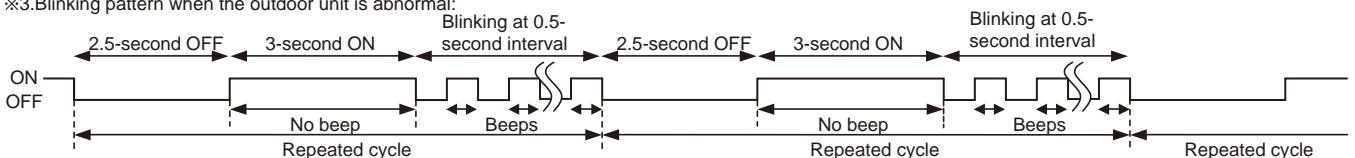

## 2. Flow chart of the detailed outdoor unit failure mode recall function

### Operational procedure

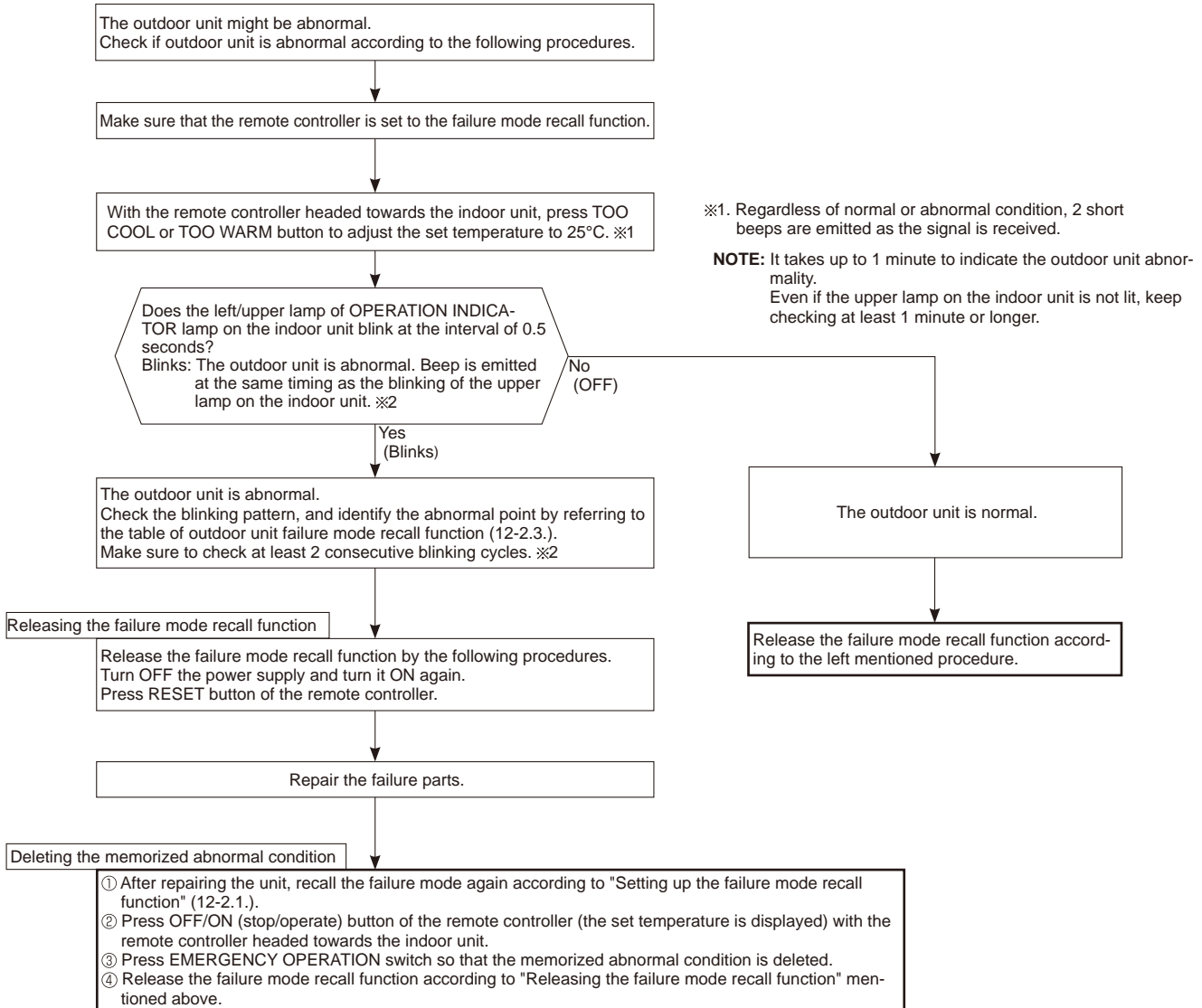

**NOTE:** 1. Make sure to release the failure mode recall function after it is set up, otherwise the unit cannot operate properly.  
2. If the abnormal condition is not deleted from the memory, the last abnormal condition is kept memorized.

※2. Blinking pattern when outdoor unit is abnormal:

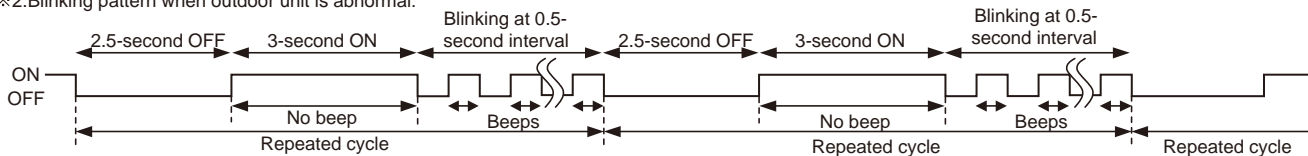



### 3. Table of outdoor unit failure mode recall function

**NOTE:** Blinking patterns of this mode differ from the ones of TROUBLESHOOTING CHECK TABLE (12-3.).

The left/ upper lamp of OPERATION INDICATOR lamp (Indoor unit)	Abnormal point (Failure mode/protection)	LED indication (Outdoor P.C. board)	Condition	Remedy	Indoor/outdoor unit failure mode recall function	Outdoor unit failure mode recall function
OFF	None (Normal)	—	—	—	—	—
1-time blink 2.5 seconds OFF	Indoor/outdoor communication, receiving error	—	Any signals from the inverter P.C. board cannot be received normally for 3 minutes.	•Refer to 12-5. ㉔ How to check miswiring and serial signal error.	○	○
	Indoor/outdoor communication, receiving error	—	Although the inverter P.C. board sends signal "0", signal "1" has been received 30 consecutive times.	•Refer to 12-5. ㉔ How to check miswiring and serial signal error.		
2-time blink 2.5 seconds OFF	Outdoor power system	—	Overcurrent protection cut-out operates 3 consecutive times within 1 minute after the compressor gets started.	•Reconnect connectors. •Refer to 12-5. ㉔ How to check inverter/compressor". •Check stop valve.	○	○
3-time blink 2.5 seconds OFF	Discharge temperature thermistor	1-time blink every 2.5 seconds	Thermistor shorts or opens during compressor running.	•Refer to 12-5. ㉔ "Check of outdoor thermistors". Defective outdoor thermistors can be identified by checking the blinking pattern of LED.	○	○
	Defrost thermistor					
	Fin temperature thermistor	3-time blink 2.5 seconds OFF				
	P.C. board temperature thermistor	4-time blink 2.5 seconds OFF				
	Ambient temperature thermistor	2-time blink 2.5 seconds OFF				
	Outdoor heat exchanger temperature thermistor	—				
4-time blink 2.5 seconds OFF	Overcurrent	11-time blink 2.5 seconds OFF	Large current flows into power module (IC700).	•Reconnect compressor connector. •Refer to 12-5. ㉔ How to check inverter/compressor". •Check stop valve.	—	○
	Compressor synchronous abnormality (Compressor startup failure protection)	12-time blink 2.5 seconds OFF	Waveform of compressor current is distorted.	•Reconnect compressor connector. •Refer to 12-5. ㉔ How to check inverter/compressor".	—	○
5-time blink 2.5 seconds OFF	Discharge temperature	—	Temperature of discharge temperature thermistor exceeds 116°C, compressor stops. Compressor can restart if discharge temperature thermistor reads 100°C or less 3 minutes later.	•Check refrigerant circuit and refrigerant amount. •Refer to 12-5. ㉔ Check of LEV".	—	○
6-time blink 2.5 seconds OFF	High pressure	—	Temperature of indoor coil thermistor exceeds 70°C in HEAT mode. Temperature of defrost thermistor exceeds 70°C in COOL mode.	•Check refrigerant circuit and refrigerant amount. •Check stop valve.	—	○
7-time blink 2.5 seconds OFF	Fin temperature/P.C. board temperature	7-time blink 2.5 seconds OFF	Temperature of fin temperature thermistor on the inverter P.C. board exceeds 75-86°C, or temperature of P.C. board temperature thermistor on the inverter P.C. board exceeds 72-85°C.	•Check around outdoor unit. •Check outdoor unit air passage. •Refer to 12-5. ㉔ Check of outdoor fan motor".	—	○
8-time blink 2.5 seconds OFF	Outdoor fan motor	—	Outdoor fan has stopped 3 times in a row within 30 seconds after outdoor fan startup.	•Refer to 12-5. ㉔ Check of outdoor fan motor". Refer to 12-5. ㉔ Check of inverter P.C. board".	—	○
9-time blink 2.5 seconds OFF	Nonvolatile memory data	5-time blink 2.5 seconds OFF	Nonvolatile memory data cannot be read properly.	•Replace the inverter P.C. board.	○	○
	Power module (IC700)	6-time blink 2.5 seconds OFF	The interface short circuit occurs in the output of the power module (IC700). The compressor winding shorts circuit.	•Refer to 12-5. ㉔ How to check inverter/compressor".		

**NOTE:** Blinking patterns of this mode differ from the ones of TROUBLESHOOTING CHECK TABLE (12-3.).

The left/ upper lamp of OPERATION INDICATOR lamp (Indoor unit)	Abnormal point (Failure mode/protection)	LED indication (Outdoor P.C. board)	Condition	Remedy	Indoor/outdoor unit failure mode recall function	Outdoor unit failure mode recall function
10-time blink 2.5 seconds OFF	Discharge temperature	—	Temperature of discharge temperature thermistor has been 50°C or less for 20 minutes.	<ul style="list-style-type: none"> <li>Refer to 12-5.⑧"Check of LEV".</li> <li>Check refrigerant circuit and refrigerant amount.</li> </ul>	—	○
11-time blink 2.5 seconds OFF	Bus-bar voltage (DC)	8-time blink 2.5 seconds OFF	Bus-bar voltage of inverter cannot be detected normally.	<ul style="list-style-type: none"> <li>Refer to 12-5.⑨"How to check inverter/compressor".</li> </ul>	—	○
	Each phase current of compressor	9-time blink 2.5 seconds OFF	Each phase current of compressor cannot be detected normally.			
14-time blink or more 2.5 seconds OFF	Stop valve (Closed valve)	14-time blink 2.5 seconds OFF	Closed valve is detected by compressor current.	<ul style="list-style-type: none"> <li>Check stop valve.</li> </ul>	○	○
	4-way valve/ Pipe temperature	16-time blink 2.5 seconds OFF	The 4-way valve does not work properly. The indoor coil thermistor detects an abnormal temperature.	<ul style="list-style-type: none"> <li>Check the 4-way valve.</li> <li>Replace the inverter P.C. board.</li> </ul>		
16-time blink 2.5 seconds OFF	Outdoor refrigerant system abnormality	1-time blink 2.5 seconds OFF	A closed valve and air trapped in the refrigerant circuit are detected based on the temperature sensed by the indoor and outdoor thermistors and the current of the compressor.	<ul style="list-style-type: none"> <li>Check for a gas leak in a connecting piping etc.</li> <li>Check the stop valve.</li> <li>Refer to 12-5. ⑩ "Check of outdoor refrigerant circuit".</li> </ul>	○	○



### 12-3. TROUBLESHOOTING CHECK TABLE

No.	Symptom	LED indication	Abnormal point/ Condition	Condition	Remedy
1	Outdoor unit does not operate.	1-time blink every 2.5 seconds	Outdoor power system	Overcurrent protection cut-out operates 3 consecutive times within 1 minute after the compressor gets started.	<ul style="list-style-type: none"> <li>•Reconnect connector of compressor.</li> <li>•Refer to 12-5.Ⓐ "How to check inverter/compressor".</li> <li>•Check stop valve.</li> </ul>
2			Outdoor thermistors	Discharge temperature thermistor, fin temperature thermistor, defrost thermistor, P.C. board temperature thermistor, outdoor heat exchanger temperature thermistor or ambient temperature thermistor shorts or opens during compressor running.	<ul style="list-style-type: none"> <li>•Refer to 12-5.Ⓒ "Check of outdoor thermistors".</li> </ul>
3			Outdoor control system	Nonvolatile memory data cannot be read properly. (The left/upper lamp of OPERATION INDICATOR lamp on the indoor unit lights up or blinks 7-time.)	<ul style="list-style-type: none"> <li>•Replace inverter P.C. board.</li> </ul>
4	'Outdoor unit stops and restarts 3 minutes later' is repeated.	6-time blink 2.5 seconds OFF	Serial signal	The communication fails between the indoor and outdoor unit for 3 minutes.	<ul style="list-style-type: none"> <li>•Refer to 12-5.Ⓜ "How to check miswiring and serial signal error.</li> </ul>
5		11-time blink 2.5 seconds OFF	Stop valve/ Closed valve	Closed valve is detected by compressor current.	<ul style="list-style-type: none"> <li>•Check stop valve.</li> </ul>
6		14-time blink 2.5 seconds OFF	Outdoor unit (Other abnormality)	Outdoor unit is defective.	<ul style="list-style-type: none"> <li>•Refer to 12-2.2. "Flow chart of the detailed outdoor unit failure mode recall function".</li> </ul>
7		16-time blink 2.5 seconds OFF	4-way valve/ Pipe temperature	The 4-way valve does not work properly. The indoor coil thermistor detects an abnormal temperature.	<ul style="list-style-type: none"> <li>•Refer to 12-5.Ⓣ "Check of R.V. coil".</li> <li>•Replace the inverter P.C. board.</li> </ul>
8		17-time blink 2.5 seconds OFF	Outdoor refrigerant system abnormality	A closed valve and air trapped in the refrigerant circuit are detected based on the temperature sensed by the indoor and outdoor thermistors and the current of the compressor.	<ul style="list-style-type: none"> <li>•Check for a gas leak in a connecting piping etc.</li> <li>•Check the stop valve.</li> <li>•Refer to 12-5.Ⓝ "Check of outdoor refrigerant circuit".</li> </ul>
9		2-time blink 2.5 seconds OFF	Overcurrent protection	Large current flows into power module (IC700).	<ul style="list-style-type: none"> <li>•Reconnect connector of compressor.</li> <li>•Refer to 12-5.Ⓐ "How to check inverter/compressor".</li> <li>•Check stop valve.</li> </ul>
10		3-time blink 2.5 seconds OFF	Discharge temperature overheat protection	Temperature of discharge temperature thermistor exceeds 116°C, compressor stops. Compressor can restart if discharge temperature thermistor reads 100°C or less 3 minutes later.	<ul style="list-style-type: none"> <li>•Check refrigerant circuit and refrigerant amount.</li> <li>•Refer to 12-5.Ⓚ "Check of LEV".</li> </ul>
11		4-time blink 2.5 seconds OFF	Fin temperature / P.C. board temperature thermistor overheat protection	Temperature of fin temperature thermistor on the heat sink exceeds 75-86°C or temperature of P.C. board temperature thermistor on the inverter P.C. board exceeds 72-85°C.	<ul style="list-style-type: none"> <li>•Check around outdoor unit.</li> <li>•Check outdoor unit air passage.</li> <li>•Refer to 12-5.Ⓛ "Check of outdoor fan motor".</li> </ul>
12	5-time blink 2.5 seconds OFF	High pressure protection	Indoor coil thermistor exceeds 70°C in HEAT mode. Defrost thermistor exceeds 70°C in COOL mode.	<ul style="list-style-type: none"> <li>•Check refrigerant circuit and refrigerant amount.</li> <li>•Check stop valve.</li> </ul>	
13	8-time blink 2.5 seconds OFF	Compressor synchronous abnormality	The waveform of compressor current is distorted.	<ul style="list-style-type: none"> <li>•Reconnect connector of compressor.</li> <li>•Refer to 12-5.Ⓐ "How to check inverter/compressor".</li> </ul>	
14	10-time blink 2.5 seconds OFF	Outdoor fan motor	Outdoor fan has stopped 3 times in a row within 30 seconds after outdoor fan startup.	<ul style="list-style-type: none"> <li>•Refer to 12-5.Ⓛ "Check of outdoor fan motor.</li> <li>•Refer to 12-5.Ⓛ "Check of inverter P.C. board.</li> </ul>	
15	12-time blink 2.5 seconds OFF	Each phase current of compressor	Each phase current of compressor cannot be detected normally.	<ul style="list-style-type: none"> <li>•Refer to 12-5.Ⓐ "How to check inverter/compressor".</li> </ul>	
16	13-time blink 2.5 seconds OFF	Bus-bar voltage (DC)	Bus-bar voltage of inverter cannot be detected normally.	<ul style="list-style-type: none"> <li>•It occurs with following case. Instantaneous power voltage drop. (Short time power failure) (HR42/50/60/71)</li> <li>•Refer to 12-5.Ⓛ "Check of power supply". (HR42/50/60/71)</li> <li>•Refer to 12-5.Ⓐ "How to check inverter/compressor".</li> </ul>	
17	Outdoor unit operates.	1-time blink 2.5 seconds OFF	Frequency drop by current protection	When the input current exceeds approximately 10A, compressor frequency lowers.	<ul style="list-style-type: none"> <li>•The unit is normal, but check the following.</li> <li>•Check if indoor filters are clogged.</li> <li>•Check if refrigerant is short.</li> <li>•Check if indoor/outdoor unit air circulation is short cycled.</li> </ul>
18		3-time blink 2.5 seconds OFF	Frequency drop by high pressure protection	Temperature of indoor coil thermistor exceeds 55°C in HEAT mode, compressor frequency lowers.	
19		Frequency drop by defrosting in COOL mode	Indoor coil thermistor reads 8°C or less in COOL mode, compressor frequency lowers.		
19	4-time blink 2.5 seconds OFF	Frequency drop by discharge temperature protection	Temperature of discharge temperature thermistor exceeds 111°C, compressor frequency lowers.	<ul style="list-style-type: none"> <li>•Check refrigerant circuit and refrigerant amount.</li> <li>•Refer to 12-5.Ⓚ "Check of LEV".</li> <li>•Refer to 12-5.Ⓒ "Check of outdoor thermistors".</li> </ul>	
20	5-time blink 2.5 seconds OFF	Outside temperature thermistor protection	When the outside temperature thermistor shorts or opens, protective operation without that thermistor is performed.	<ul style="list-style-type: none"> <li>•Refer to 12-5.Ⓒ Check of outdoor thermistors.</li> </ul>	



No.	Symptom	LED indication	Abnormal point/ Condition	Condition	Remedy
21	Outdoor unit operates.	7-time blink 2.5 seconds OFF	Low discharge temperature protection	Temperature of discharge temperature thermistor has been 50°C or less for 20 minutes.	<ul style="list-style-type: none"> <li>Refer to 12-5.Ⓢ "Check of LEV".</li> <li>Check refrigerant circuit and refrigerant amount.</li> </ul>
22		8-time blink 2.5 seconds OFF	PAM protection PAM: Pulse Amplitude Modulation	The overcurrent flows into PFC (Power factor correction: IC820) or the bus-bar voltage reaches 394 V or more, PAM stops and restarts.	This is not malfunction. PAM protection will be activated in the following cases: <ol style="list-style-type: none"> <li>Instantaneous power voltage drop. (Short time power failure)</li> <li>When the power supply voltage is high.</li> </ol>
23		9-time blink 2.5 seconds OFF	Inverter check mode	The connector of compressor is disconnected, inverter check mode starts.	<ul style="list-style-type: none"> <li>Check if the connector of the compressor is correctly connected. Refer to 12-5.Ⓐ "How to check inverter/compressor".</li> </ul>

**NOTE:** 1. The location of LED is illustrated at the right figure. Refer to 12-6.1.  
 2. LED is lit during normal operation.

The blinking frequency shows the number of times the LED blinks after every 2.5-second OFF.  
 (Example) When the blinking frequency is "2".

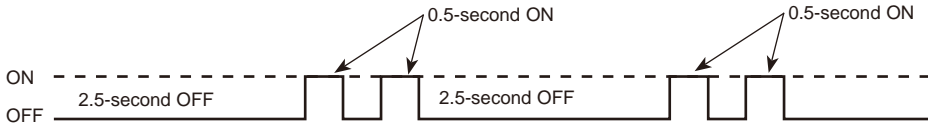

Inverter P.C. board

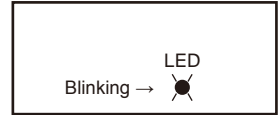

## 12-4. TROUBLE CRITERION OF MAIN PARTS

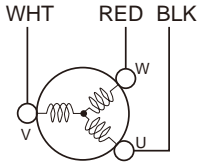
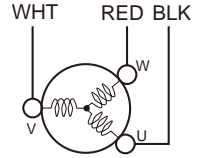
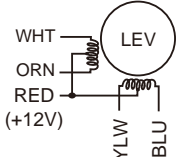
Part name	Check method and criterion	Figure										
Defrost thermistor (RT61) Fin temperature thermistor (RT64) Ambient temperature thermistor (RT65) Outdoor heat exchanger temperature thermistor (RT68)	Measure the resistance with a tester.  Refer to 12-6. "Test point diagram and voltage", 1. "Inverter P.C. board", for the chart of thermistor.											
Discharge temperature thermistor (RT62)	Measure the resistance with a tester. Before measurement, hold the thermistor with your hands to warm it up.  Refer to 12-6. "Test point diagram and voltage", 1. "Inverter P.C. board", for the chart of thermistor.											
Compressor	Measure the resistance between terminals using a tester. (Temperature: -10 to 40°C) <table border="1" style="margin-left: 20px;"> <thead> <tr> <th rowspan="2"></th> <th colspan="2">Normal</th> </tr> <tr> <th>MUZ-HR25/35VF</th> <th>MUZ-HR42/50VF MUZ-HR60/71VF</th> </tr> </thead> <tbody> <tr> <td>U-V</td> <td rowspan="3">1.59-2.16 Ω</td> <td rowspan="3">0.82-1.11 Ω</td> </tr> <tr> <td>U-W</td> </tr> <tr> <td>V-W</td> </tr> </tbody> </table>		Normal		MUZ-HR25/35VF	MUZ-HR42/50VF MUZ-HR60/71VF	U-V	1.59-2.16 Ω	0.82-1.11 Ω	U-W	V-W	
	Normal											
	MUZ-HR25/35VF	MUZ-HR42/50VF MUZ-HR60/71VF										
U-V	1.59-2.16 Ω	0.82-1.11 Ω										
U-W												
V-W												
Outdoor fan motor	Measure the resistance between lead wires using a tester. (Temperature: -10 to 40°C) <table border="1" style="margin-left: 20px;"> <thead> <tr> <th rowspan="2">Color of lead wire</th> <th colspan="2">Normal</th> </tr> <tr> <th>MUZ-HR25/35VF</th> <th>MUZ-HR42/50VF MUZ-HR60/71VF</th> </tr> </thead> <tbody> <tr> <td>RED – BLK</td> <td rowspan="3">32-43 Ω</td> <td rowspan="3">15-20 Ω</td> </tr> <tr> <td>BLK – WHT</td> </tr> <tr> <td>WHT – RED</td> </tr> </tbody> </table>	Color of lead wire	Normal		MUZ-HR25/35VF	MUZ-HR42/50VF MUZ-HR60/71VF	RED – BLK	32-43 Ω	15-20 Ω	BLK – WHT	WHT – RED	
Color of lead wire	Normal											
	MUZ-HR25/35VF	MUZ-HR42/50VF MUZ-HR60/71VF										
RED – BLK	32-43 Ω	15-20 Ω										
BLK – WHT												
WHT – RED												
R. V. coil (21S4)	Measure the resistance using a tester. (Temperature: -10 to 40°C) <table border="1" style="margin-left: 20px;"> <thead> <tr> <th>Normal</th> </tr> </thead> <tbody> <tr> <td>1.41-2.00 kΩ</td> </tr> </tbody> </table>	Normal	1.41-2.00 kΩ									
Normal												
1.41-2.00 kΩ												
Expansion valve coil (LEV)	Measure the resistance using a tester. (Temperature: -10 to 40°C) <table border="1" style="margin-left: 20px;"> <thead> <tr> <th>Color of lead wire</th> <th>Normal</th> </tr> </thead> <tbody> <tr> <td>RED – ORN</td> <td rowspan="5">37-54 Ω</td> </tr> <tr> <td>RED – WHT</td> </tr> <tr> <td>RED – BLU</td> </tr> <tr> <td>RED – YLW</td> </tr> <tr> <td>RED – YLW</td> </tr> </tbody> </table>	Color of lead wire	Normal	RED – ORN	37-54 Ω	RED – WHT	RED – BLU	RED – YLW	RED – YLW			
Color of lead wire	Normal											
RED – ORN	37-54 Ω											
RED – WHT												
RED – BLU												
RED – YLW												
RED – YLW												

## 12-5. TROUBLESHOOTING FLOW

### A How to check inverter/compressor

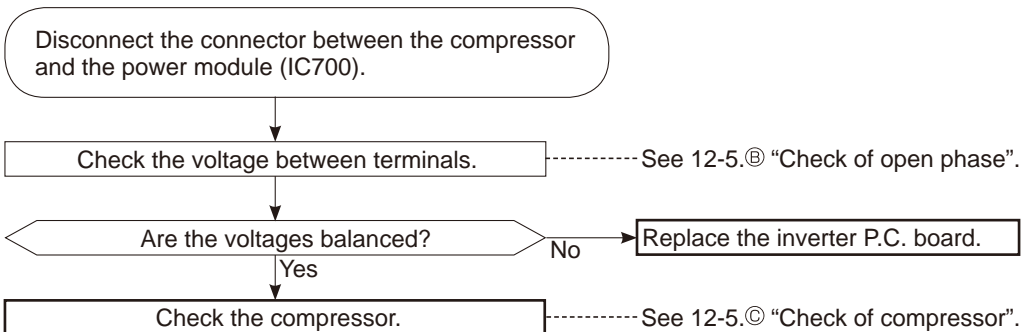

### B Check of open phase

- With the connector between the compressor and the power module (IC700) disconnected, activate the inverter and check if the inverter is normal by measuring **the voltage balance** between the terminals.

Output voltage is 50 - 130 V. (The voltage may differ according to the tester.)

#### << Operation method >>

Start cooling or heating operation by pressing EMERGENCY OPERATION switch on the indoor unit. (TEST RUN OPERATION: Refer to 9-3.)

#### << Measurement point >>

At 3 points

BLK (U)-WHT (V) ※ Measure AC voltage between the lead wires at 3 points.

BLK (U)-RED (W)

WHT(V)-RED (W)

- NOTE:** 1. Output voltage varies according to power supply voltage.  
 2. Measure the voltage by analog type tester.  
 3. During this check, LED of the inverter P.C. board blinks 9 times. (Refer to 12-6.1.)

### C Check of compressor

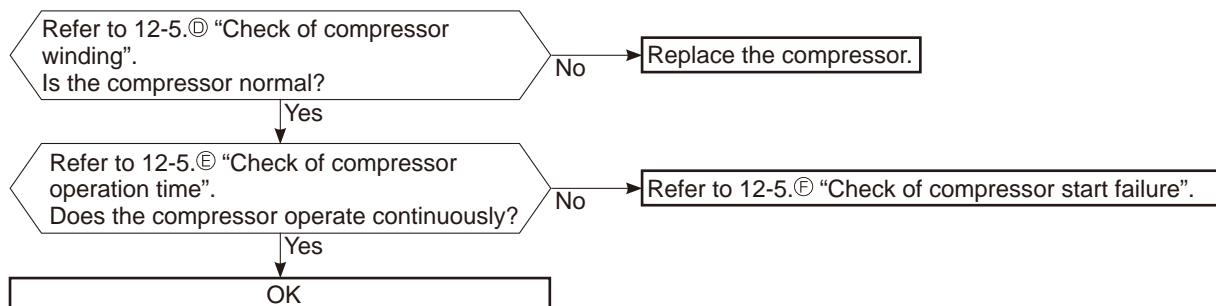

### D Check of compressor winding

- Disconnect the connector between the compressor and the power module (IC700), and measure the resistance between the compressor terminals.

<<Measurement point>>

At 3 points

BLK-WHT

BLK-RED

WHT-RED

※ Measure the resistance between the lead wires at 3 points.

<<Judgement>>

Refer to 12-4.

0 [Ω] .....Abnormal [short]

Infinite [Ω] .....Abnormal [open]

**NOTE:** Be sure to zero the ohmmeter before measurement.

### E Check of compressor operation time

- Connect the compressor and activate the inverter. Then measure the time until the inverter stops due to overcurrent.

<<Operation method>>

Start heating or cooling operation by pressing EMERGENCY OPERATION switch on the indoor unit. (TEST RUN OPERATION: Refer to 9-3.)

<<Measurement>>

Measure the time from the start of compressor to the stop of compressor due to overcurrent.

<<Judgement>>

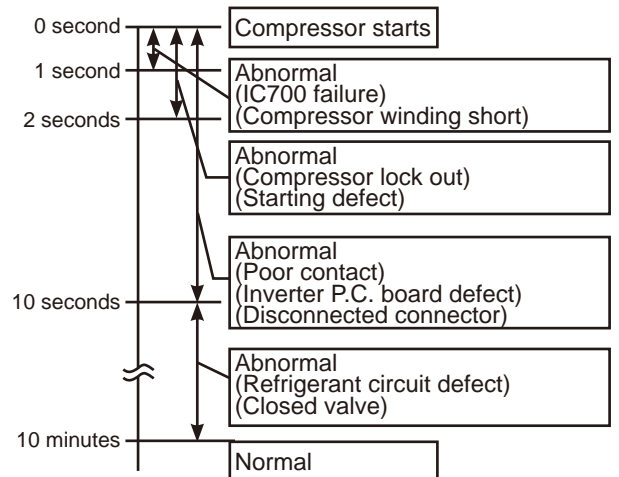

### F Check of compressor start failure

Confirm that ①~④ is normal.

- Electrical circuit check

①. Contact of the compressor connector

②. Output voltage of inverter P.C. board and balance of them (See 12-5.⑥)

③. Direct current voltage between DB61(+) and (-) on the inverter P.C. board

④. Voltage between outdoor terminal block S1-S2

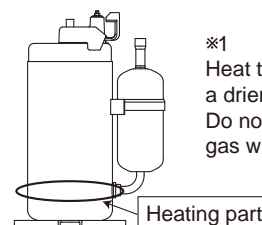
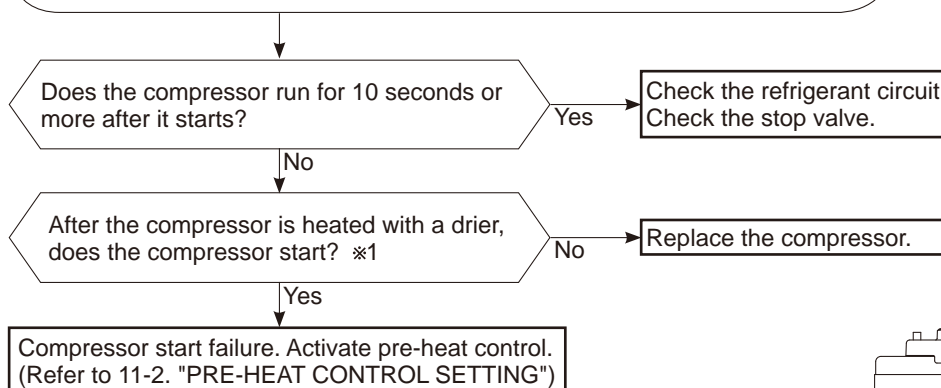

※1 Heat the compressor with a drier for about 20 minutes. Do not recover refrigerant gas while heating.

## Ⓒ Check of outdoor thermistors

Disconnect the connector of thermistor in the inverter P.C. board (see below table), and measure the resistance of thermistor.

Is the resistance of thermistor normal?  
(Refer to 12-6.1.)

No

Replace the thermistor except RT64.  
When RT64 is abnormal, replace the inverter P.C. board.

Yes

Reconnect the connector of thermistor.  
Turn ON the power supply and press EMERGENCY OPERATION switch.

Does the unit operate for 10 minutes or more  
without showing thermistor abnormality?

No

Replace the inverter P.C. board.

Yes

OK (Cause is poor contact.)

Thermistor	Symbol	Connector, Pin No.	Board
Defrost	RT61	Between CN641 pin1 and pin2	Inverter P.C. board
Discharge temperature	RT62	Between CN641 pin3 and pin4	
Fin temperature	RT64	Between CN642 pin1 and pin2	
Ambient temperature	RT65	Between CN643 pin1 and pin2	
Outdoor heat exchanger temperature	RT68	Between CN644 pin1 and pin3	



**H Check of R.V. coil**

- First of all, measure the resistance of R.V. coil to check if the coil is defective. Refer to 12-4.
- In case CN721 is disconnected or R.V. coil is open, voltage is generated between the terminal pins of the connector although no signal is being transmitted to R.V. coil.  
Check if CN721 is connected.

**Unit operates in COOL mode even if it is set to HEAT mode.**

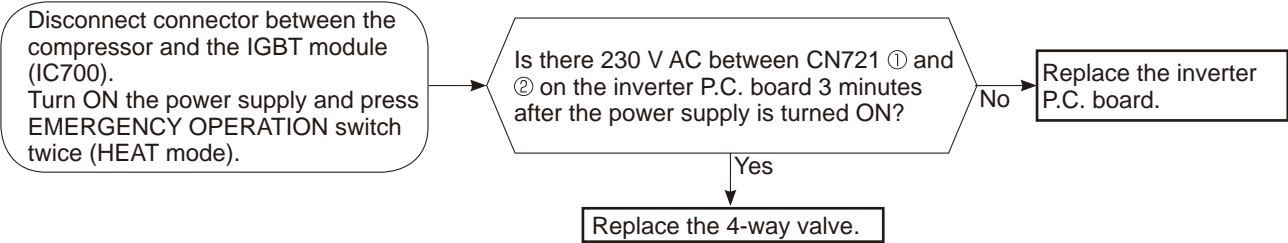

**Unit operates in HEAT mode even if it is set to COOL mode.**

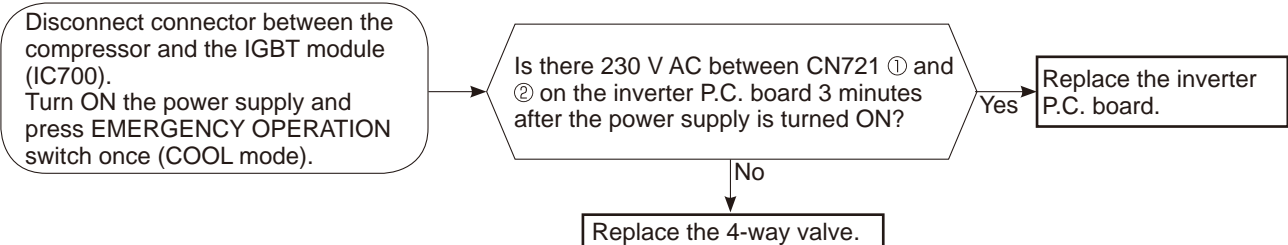

### ① Check of outdoor fan motor

Disconnect the connectors CN931 and CN932 from the inverter P.C. board.  
Check the connection between the connector CN931 and CN932.

Is the resistance between each terminal of outdoor fan motor normal?  
(Refer to 12-4.)

Yes

No

Disconnect CN932 from the inverter P.C. board, and turn on the power supply.

Rotate the outdoor fan motor manually and measure the voltage of CN931.  
Between 1(+) and 5(-)  
Between 2(+) and 5(-)  
Between 3(+) and 5(-)

Does the voltage between each terminal become 5 and 0 V DC repeatedly?

Yes

(Fixed to either 5 or 0 V DC)

No

Does the outdoor fan motor rotate smoothly?

Yes

No

Replace the inverter P.C. board.

Replace the outdoor fan motor.



**J Check of power supply**

Disconnect the connector between the compressor and the power module (IC700). Turn ON power supply and press EMERGENCY OPERATION switch.

Does the left/upper lamp of OPERATION INDICATOR lamp on the indoor unit light up?

Yes

Is there bus-bar voltage 260 - 370 V DC between DB61 (+) and DB61 (-) on the inverter P.C. board? (Refer to 12-6.1.)

No

Check the electric parts in main circuit.

Is there voltage 230 V AC between the indoor terminal block S1 and S2?

Yes

Rectify indoor/outdoor connecting wire.

Replace the indoor electronic control P.C. board.

Does LED on the inverter P.C. board light up or blink? (Refer to 12-6.1.)

No

Replace the inverter P.C. board.

Yes

If lights up, OK.  
If blinks, refer to 12-3.

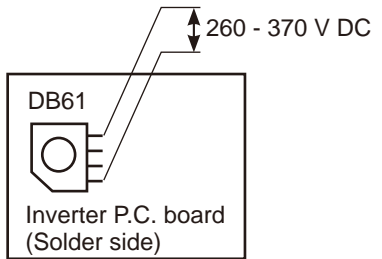

## K Check of LEV (Expansion valve)

Turn ON the power supply.  
 <Preparation of the remote controller>  
 ① While pressing both OPERATION SELECT button and TOO COOL button on the remote controller at the same time, press RESET button.  
 ② First, release RESET button.  
 Hold down the other 2 buttons for another 3 seconds. Make sure that the indicators on the LCD screen shown in the right figure are all displayed. Then release the buttons.

MSZ-HR-VF

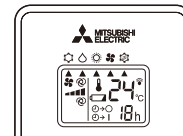
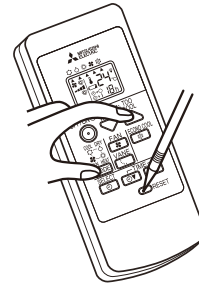

Press OFF/ON (stop/operate) button of the remote controller (the set temperature is displayed) with the remote controller headed towards the indoor unit. ※1

Expansion valve operates in full-opening direction.

Do you hear the expansion valve "click, click....." ?  
 Do you feel the expansion valve vibrate when touching it ?

Yes → OK

No

Is LEV coil properly fixed to the expansion valve?

No

Properly fix the LEV coil to the expansion valve.

Yes

Does the resistance of LEV coil have the characteristics? (Refer to 12-4.)

Yes

Measure each voltage between connector pins of CN724 on the inverter P.C. board.  
 1. Pin③(-) — Pin①(+)  
 2. Pin④(-) — Pin①(+)  
 3. Pin⑤(-) — Pin①(+)  
 4. Pin⑥(-) — Pin①(+)  
 Is there about 3 - 5 V AC between each?  
**NOTE:** Measure the voltage by an analog tester.

No → Replace the inverter P.C. board.

No

Replace the LEV coil.

Yes

Replace the expansion valve.

※1. Regardless of normal or abnormal condition, a short beep is emitted once the signal is received.

**NOTE:** After check of LEV, take the following steps.

1. Turn OFF the power supply and turn it ON again.
2. Press RESET button on the remote controller.

**L Check of inverter P.C. board**

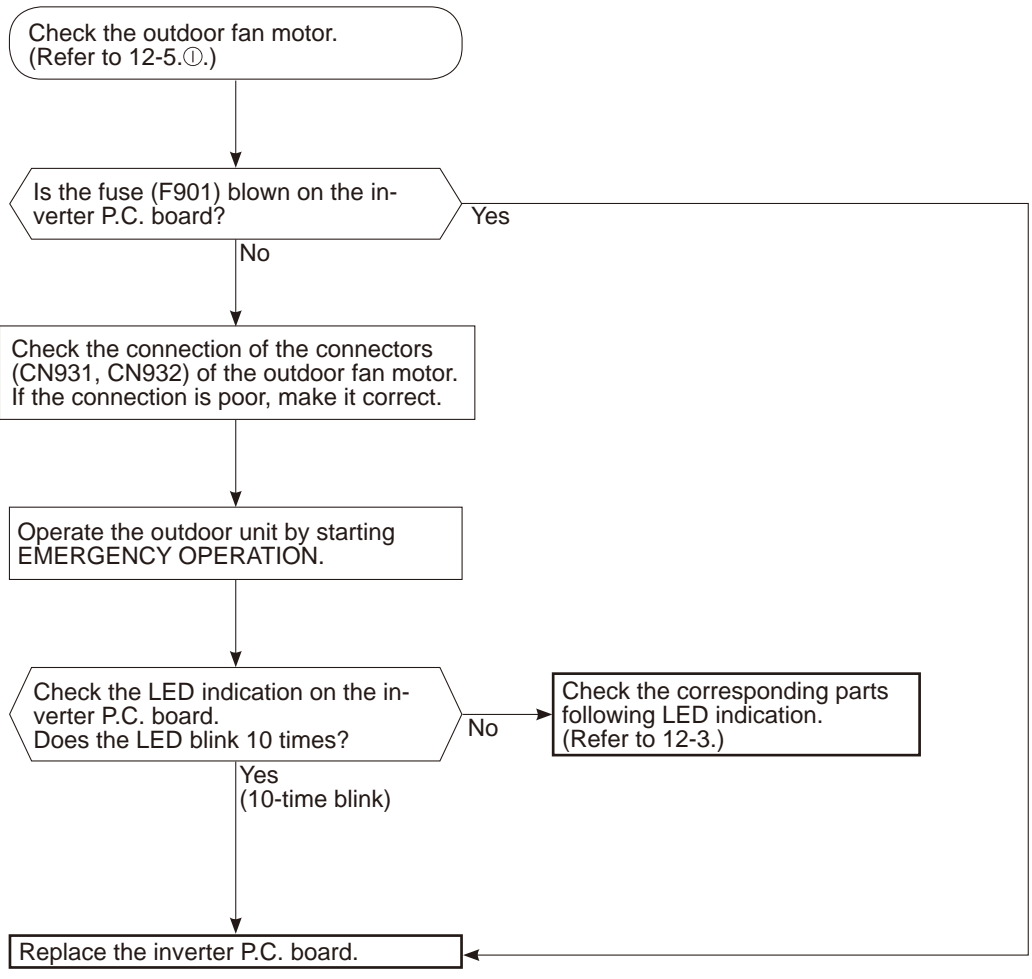

## M How to check miswiring and serial signal error

HR25/35/42/50VF

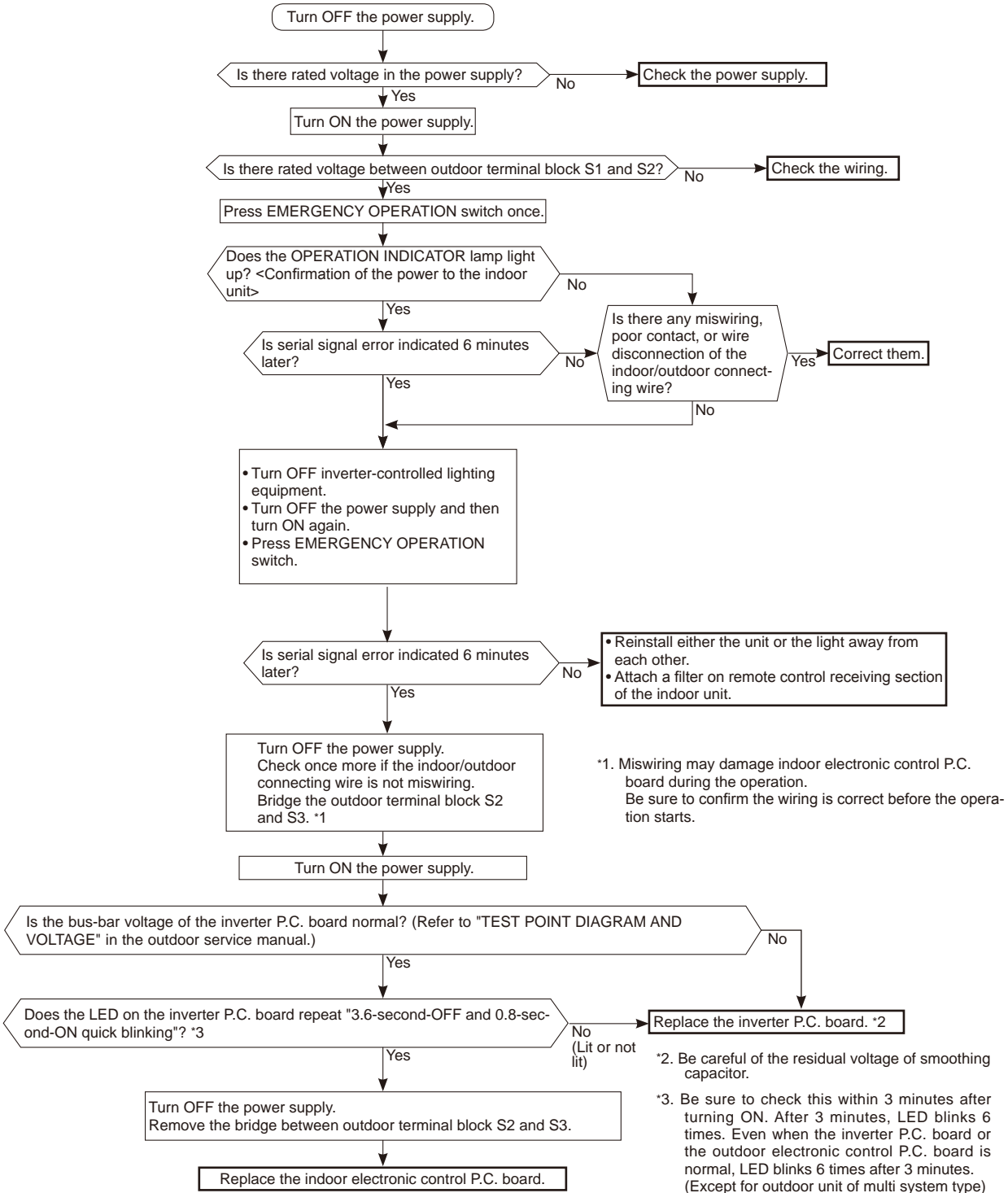

HR60/71VF

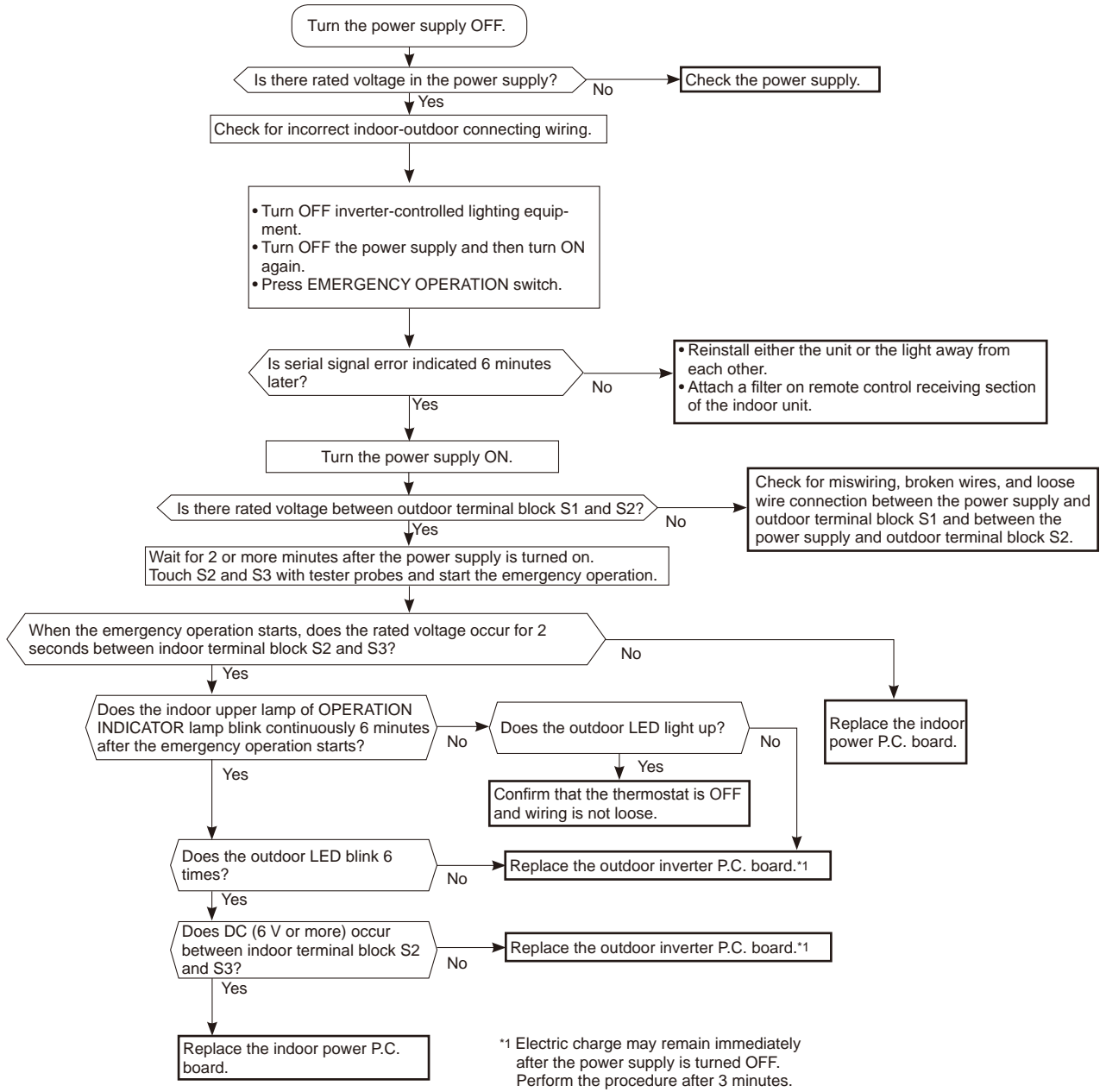

**N Check of the outdoor refrigerant circuit**

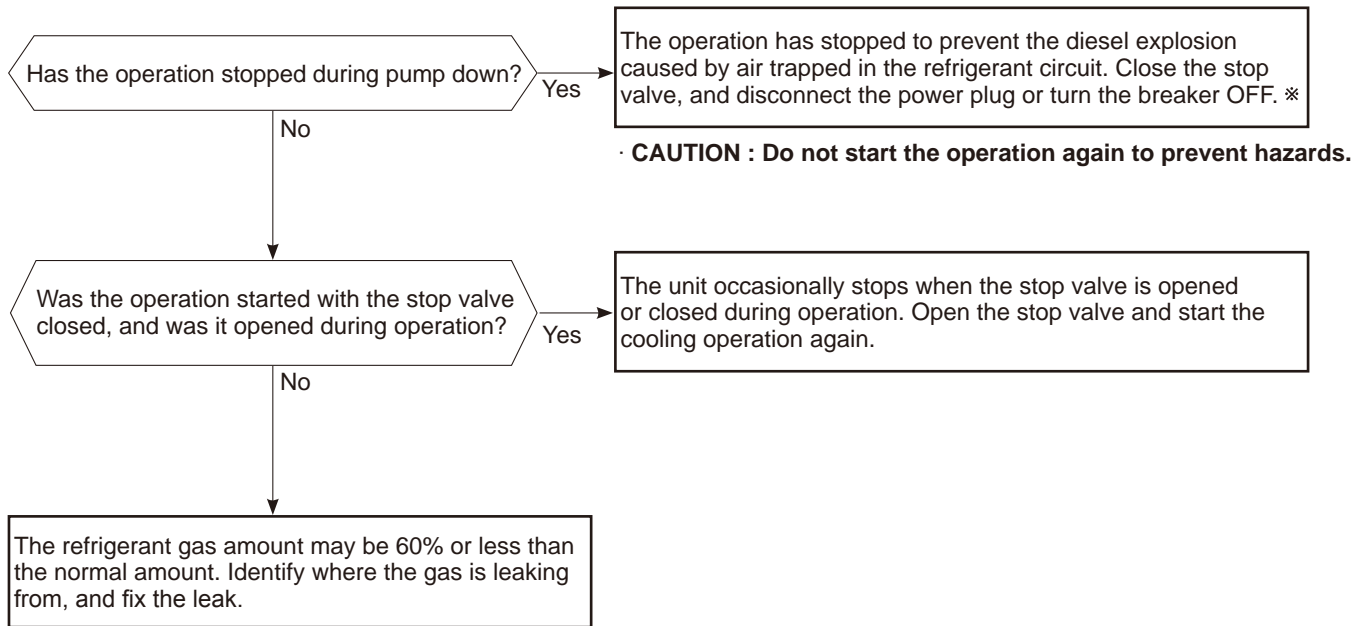

## ① Electromagnetic noise enters into TV sets or radios

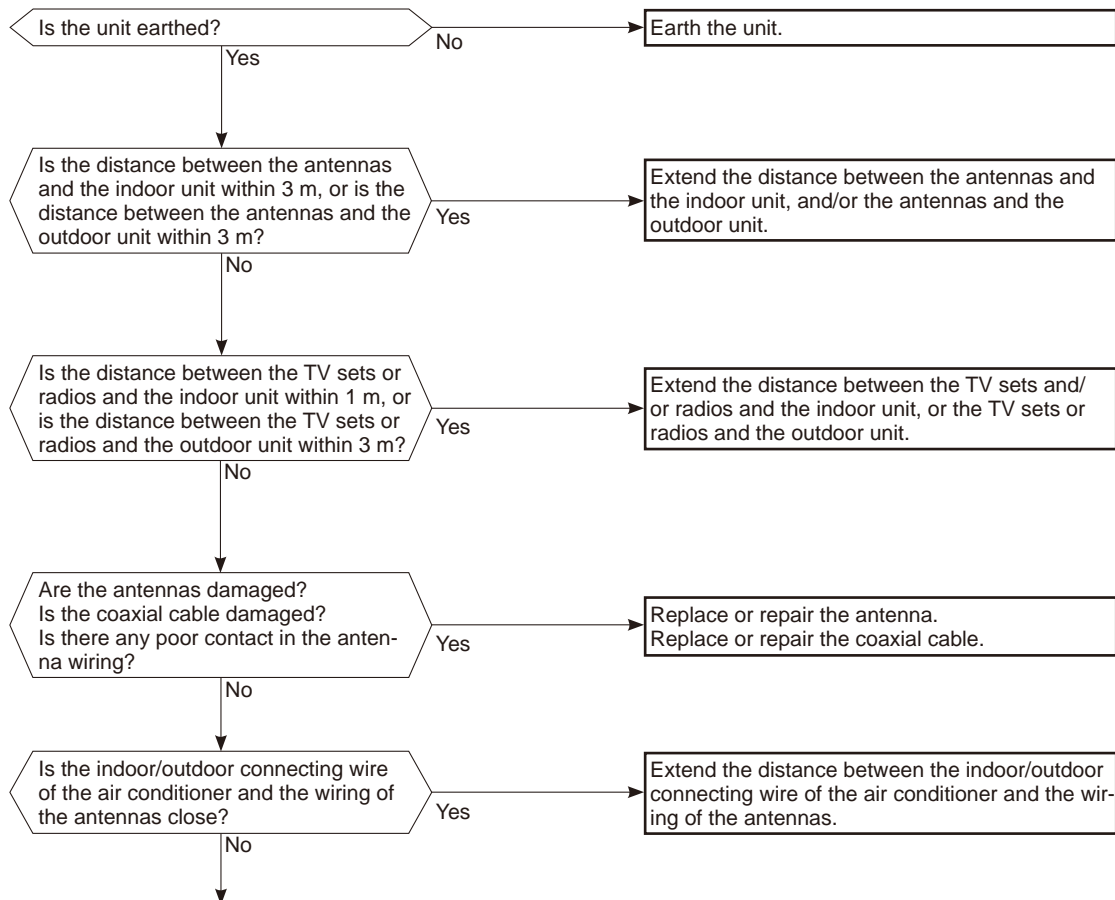

Even if all of the above conditions are fulfilled, the electromagnetic noise may enter, depending on the electric field strength or the installation condition (combination of specific conditions such as antennas or wiring). Check the following before asking for service.

1. Devices affected by the electromagnetic noise  
TV sets, radios (FM/AM broadcast, shortwave)
2. Channel, frequency, broadcast station affected by the electromagnetic noise
3. Channel, frequency, broadcast station unaffected by the electromagnetic noise
4. Layout of:  
indoor/outdoor unit of the air conditioner, indoor/outdoor wiring, earth wire, antennas, wiring from antennas, receiver
5. Electric field intensity of the broadcast station affected by the electromagnetic noise
6. Presence or absence of amplifier such as booster
7. Operation condition of air conditioner when the electromagnetic noise enters in
  - 1) Turn OFF the power supply once, and then turn ON the power supply. In this situation, check for the electromagnetic noise.
  - 2) Within 3 minutes after turning ON the power supply, press OFF/ON (stop/operate) button on the remote controller for power ON, and check for the electromagnetic noise.
  - 3) After a short time (3 minutes later after turning ON), the outdoor unit starts running. During operation, check for the electromagnetic noise.
  - 4) Press OFF/ON (stop/operate) button on the remote controller for power OFF, when the outdoor unit stops but the indoor/outdoor communication still runs on. In this situation, check for the electromagnetic noise.

## 12-6. TEST POINT DIAGRAM AND VOLTAGE

### 1. Inverter P.C. board

MUZ-HR25VF MUZ-HR35VF

Back side of unit

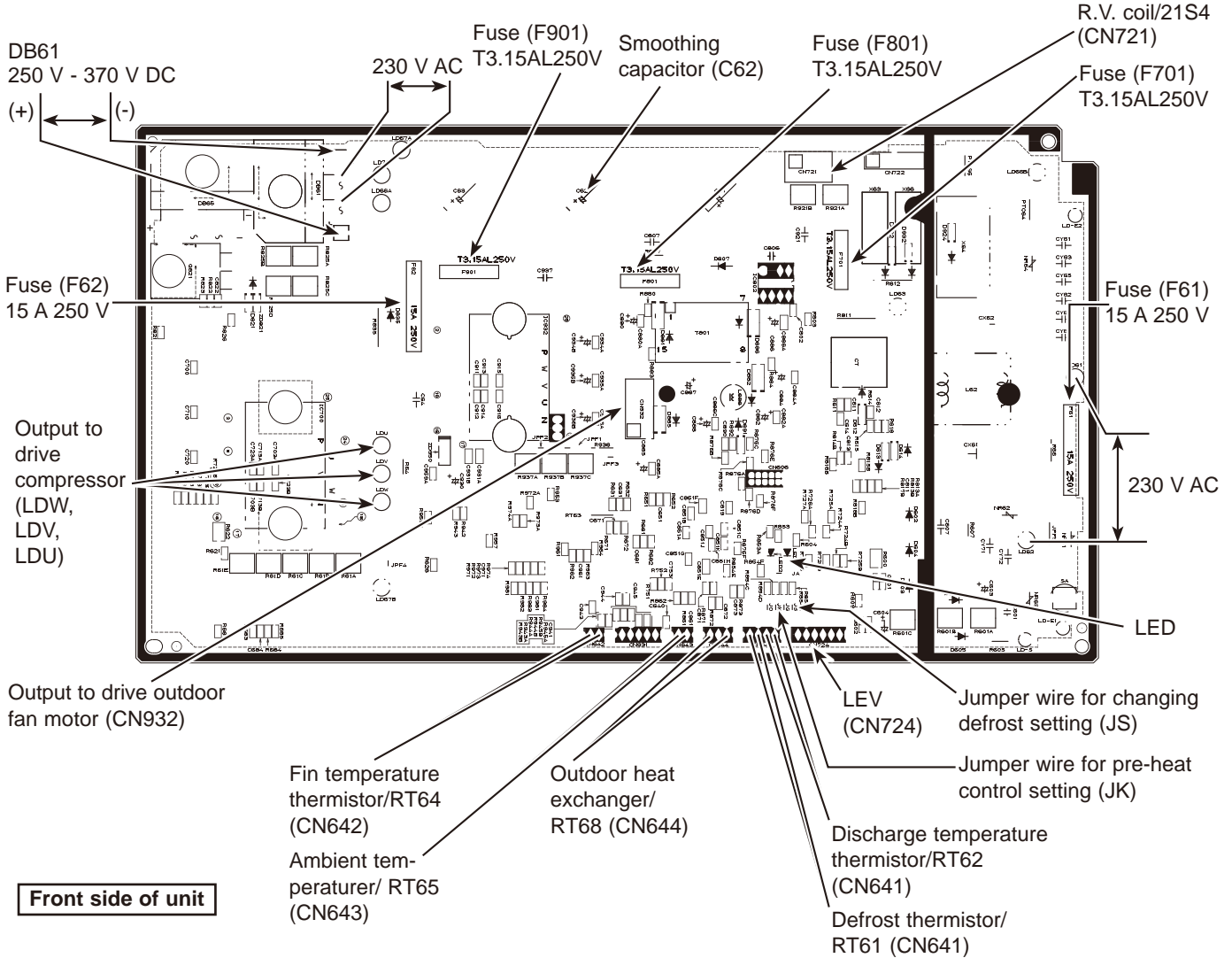

Front side of unit

Defrost thermistor (RT61)  
Ambient temperature thermistor (RT65)  
Outdoor heat exchanger temperature thermistor (RT68)

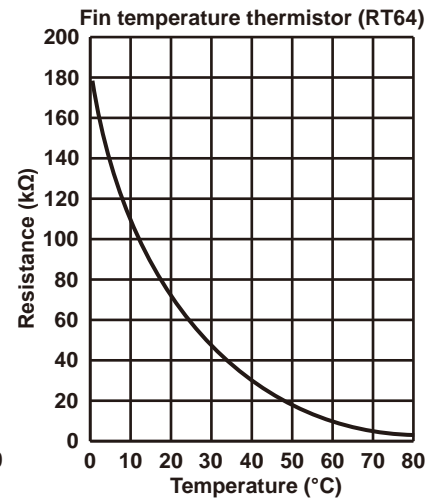
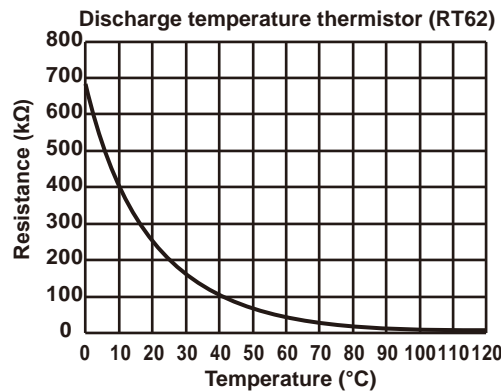
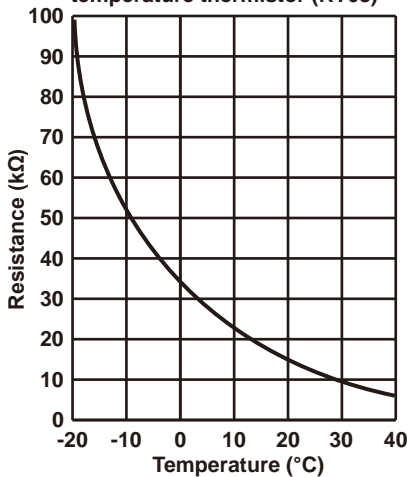



1. Inverter P.C. board

MUZ-HR42VF MUZ-HR50VF MUZ-HR60VF MUZ-HR71VF

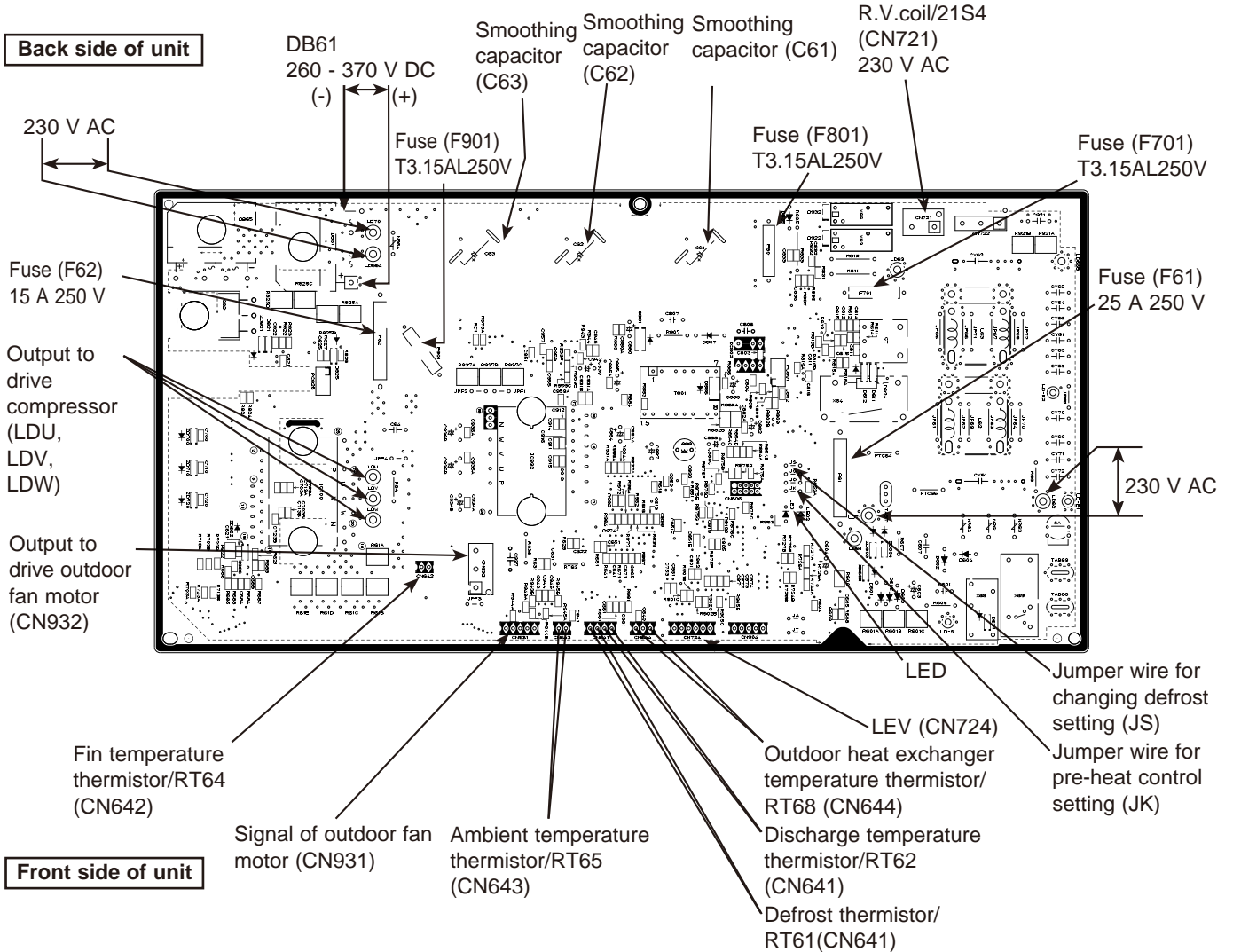

Defrost thermistor(RT61)  
Ambient temperature thermistor(RT65)  
Outdoor heat exchanger temperature thermistor(RT68)

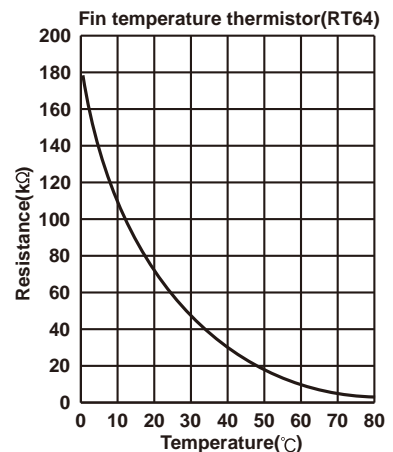
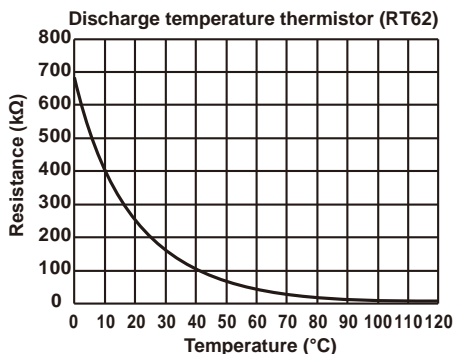
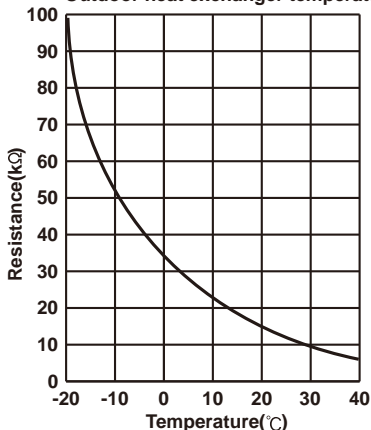

**<Detaching method of the terminal with locking mechanism >**

The terminal which has the locking mechanism can be detached as shown below.

There are following 2 types of the terminal with locking mechanism.

The terminal without locking mechanism can be detached by pulling it out.

Check the shape of the terminal before detaching.

(1) Slide the sleeve and check if there is a locking lever or not.

(2) The terminal with this connector shown below has the locking mechanism.

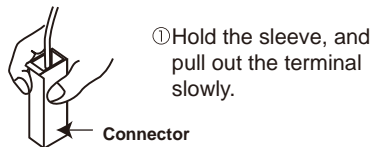
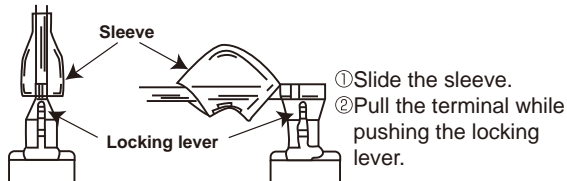

**13-1. MUZ-HR25VF MUZ-HR35VF**

**NOTE:** Turn OFF the power supply before disassembly.

→ : Indicates the visible parts in the photos.  
---→ : Indicates the invisible parts in the photos.

OPERATING PROCEDURE	PHOTOS
<p><b>1. Removing the cabinet and the panels</b></p> <ol style="list-style-type: none"> <li>(1) Remove the screws fixing the service panel.</li> <li>(2) Pull down the service panel and remove it.</li> <li>(3) Disconnect the power supply cord and indoor/outdoor connecting wire.</li> <li>(4) Remove the screws fixing the top panel.</li> <li>(5) Remove the top panel.</li> <li>(6) Remove the screws fixing the cabinet.</li> <li>(7) Remove the cabinet.</li> <li>(8) Remove the fixing screws of the terminal block support and the back panel. (Photo 4)</li> <li>(9) Remove the screws fixing the back panel.</li> <li>(10) Remove the back panel.</li> </ol> <p><b>Photo 2</b></p> <p>Screws of the top panel Service panel Direction to remove Screws of the service panel Hooks Screw of the cabinet</p>	<p><b>Photo 1</b></p> <p>Screws of the top panel Screws of the cabinet Screws of the cabinet</p> <p><b>Photo 3</b></p> <p>Screw of the back panel Screws of the back panel</p>

## OPERATING PROCEDURE

### 2. Removing the inverter assembly, inverter P.C. board

- (1) Remove the cabinet and the panels. (Refer to section 1.)
- (2) Disconnect the lead wire to the reactor and the following connectors:  
<Inverter P.C. board>  
CN721 (R.V. coil)  
CN931, CN932 (Fan motor)  
CN641 (Defrost thermistor and discharge temperature thermistor)  
CN643 (Ambient temperature thermistor)  
CN644 (Outdoor heat exchanger temperature thermistor)  
CN724 (LEV)
- (3) Remove the compressor connector (CN61).
- (4) Remove the screw fixing the heat sink support and the separator.
- (5) Remove the screw fixing the P.C board support and the motor support.
- (6) Remove the inverter assembly.
- (7) Remove the screws of the earth wire and the terminal block support.
- (8) Remove the screw of the terminal block and remove the terminal block.
- (9) Remove the heat sink support from the P.C. board support.
- (10) Unhook the catch of the inverter P.C. board and remove the inverter P.C. board from the P.C. board support.

### 3. Removing the R.V. coil

- (1) Remove the cabinet and the panels. (Refer to section 1.)
- (2) Disconnect the following connectors:  
<Inverter P.C. board>  
CN721 (R.V. coil)
- (3) Remove the R.V. coil.

## PHOTOS

Photo 4

Screw of the heat sink support and the separator

Screws of the terminal block support and the back panel

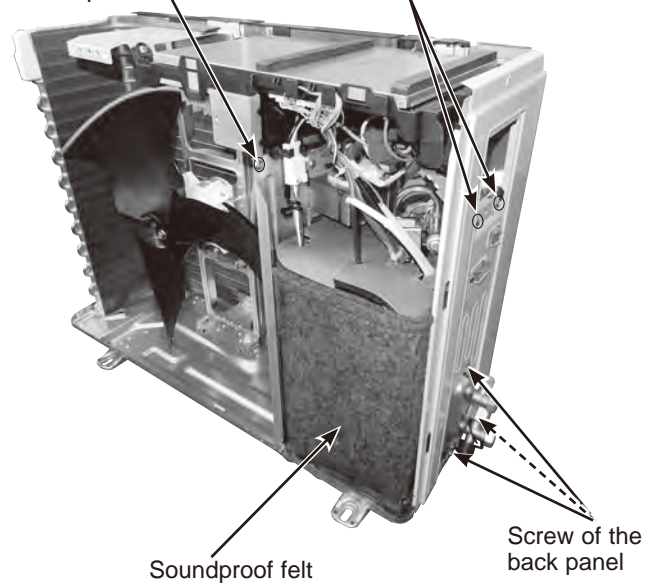
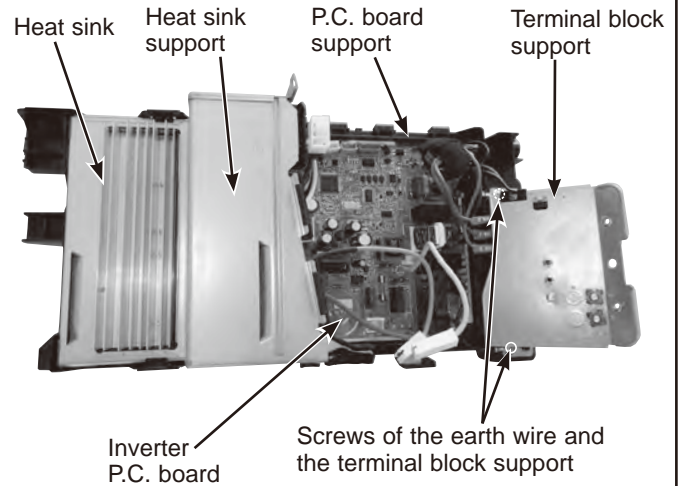

Photo 5 (Inverter assembly)



## OPERATING PROCEDURE

### 4. Removing the discharge temperature thermistor, the defrost thermistor, the ambient temperature thermistor and the outdoor heat exchanger temperature thermistor

- (1) Remove the cabinet and the panels. (Refer to section 1.)
- (2) Disconnect the lead wire to the reactor and the following connectors:
  - <Inverter P.C. board>
  - CN641 (Defrost thermistor and discharge temperature thermistor)
  - CN643 (Ambient temperature thermistor)
  - CN644 (Outdoor heat exchanger temperature thermistor)
- (3) Pull out the discharge temperature thermistor from its holder.
- (4) Pull out the defrost thermistor from its holder. (Photo 9)
- (5) Pull out the outdoor heat exchanger temperature thermistor from its holder.
- (6) Pull out the ambient temperature thermistor from its holder.

### 5. Removing the outdoor fan motor

- (1) Remove the cabinet and the panels. (Refer to section 1.)
- (2) Disconnect the following connectors:
  - <Inverter P.C. board>
  - CN931, CN932 (Fan motor)
- (3) Remove the fan motor lead wire from where it is fastened on the separator.
- (4) Remove the propeller fan nut.
- (5) Remove the propeller fan.
- (6) Remove the screws fixing the fan motor.
- (7) Remove the fan motor.

## PHOTOS

Photo 6

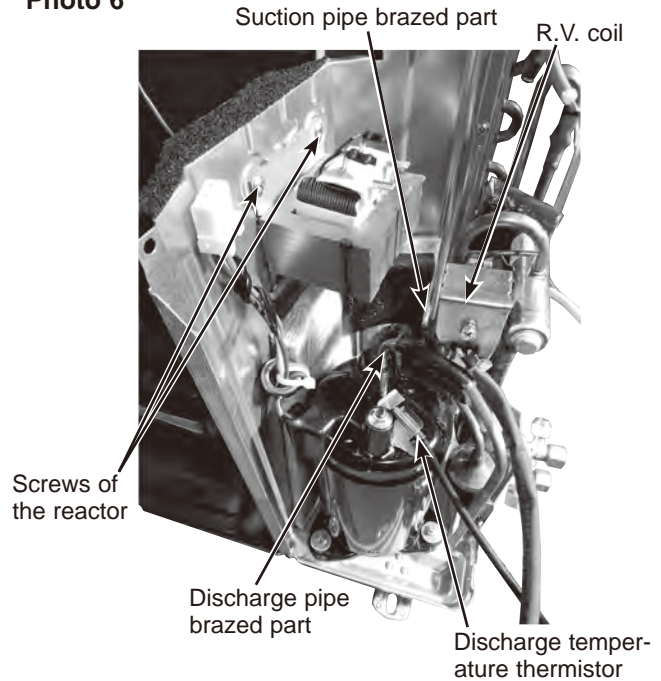

Photo 7

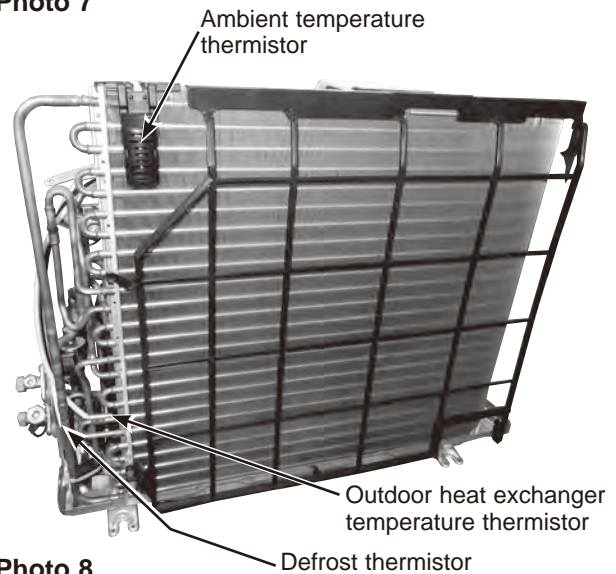
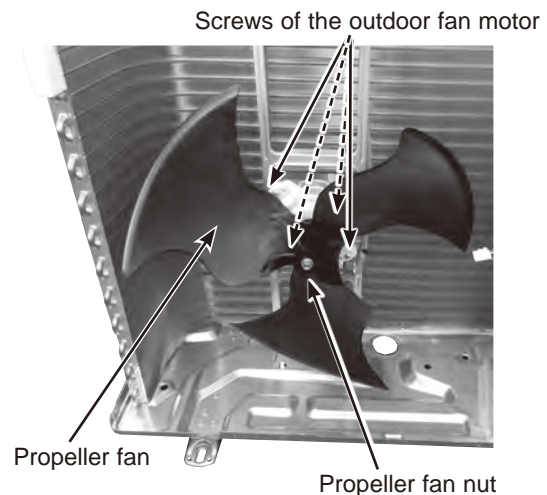
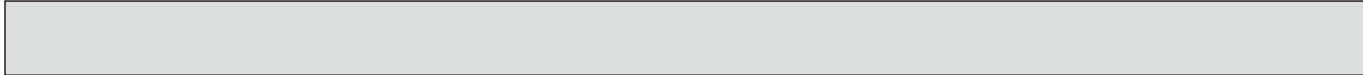
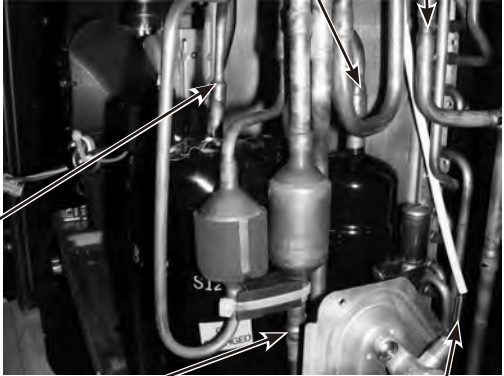

Photo 8





OPERATING PROCEDURE	PHOTOS
<p><b>6. Removing the compressor and the 4-way valve</b></p> <ul style="list-style-type: none"><li>(1) Remove the cabinet and the panels. (Refer to section 1.)</li><li>(2) Remove the inverter assembly. (Refer to section 2.)</li><li>(3) Remove the screws of the reactor and remove the reactor.</li><li>(4) Remove the screws of the separator and remove the separator.</li><li>(5) Remove the soundproof felt.</li><li>(6) Remove the terminal cover and the compressor lead wire.</li><li>(7) Recover gas from the refrigerant circuit. <b>NOTE:</b> Recover gas from the pipes until the pressure gauge shows 0 kg/cm<sup>2</sup> (0 MPa).</li><li>(8) Detach the brazed part of the suction and the discharge pipe connected with the compressor.</li><li>(9) Detach the brazed part of pipes connected with the 4-way valve.</li><li>(10) Remove the nuts of compressor legs.</li><li>(11) Remove the compressor.</li></ul>	<p><b>Photo 9</b></p>  <p>Suction pipe brazed part      4-way valve brazed part</p> <p>Discharge pipe brazed part</p> <p>4-way valve brazed part      Defrost thermistor</p>

## 13-2. MUZ-HR42VF MUZ-HR50VF

**NOTE:** Turn OFF the power supply before disassembly.

Photos: **MUZ-HR42VF**

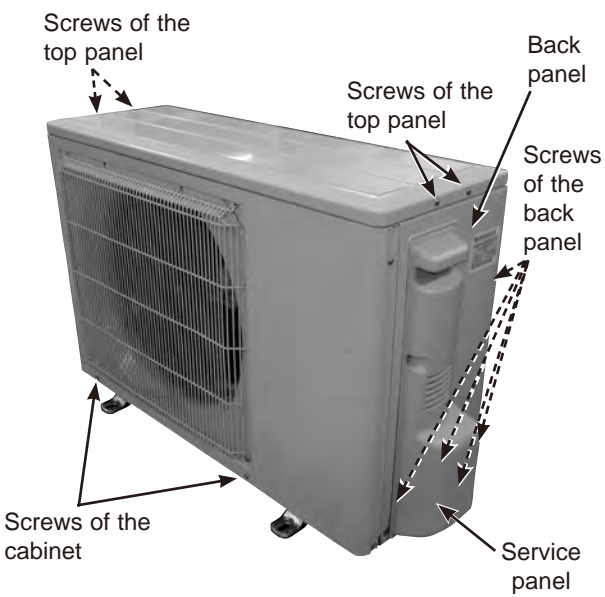
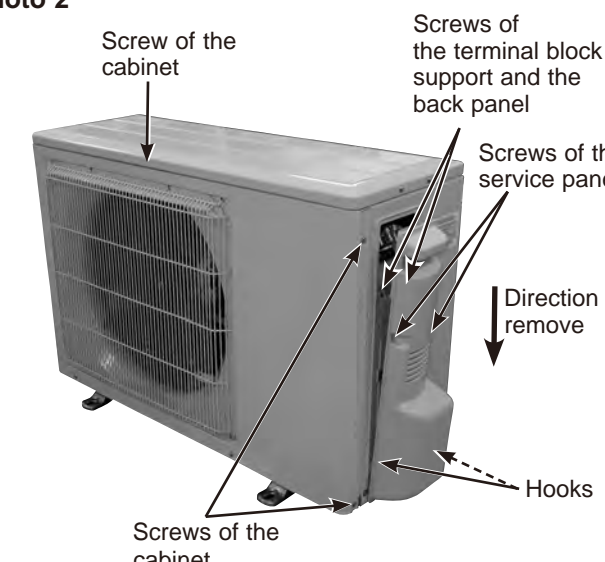
OPERATING PROCEDURE	PHOTOS
<p><b>1. Removing the cabinet</b></p> <ol style="list-style-type: none"><li>(1) Remove the screw fixing the service panel.</li><li>(2) Pull down the service panel and remove it.</li><li>(3) Disconnect the power supply cord and indoor/outdoor connecting wire.</li><li>(4) Remove the screws fixing the top panel.</li><li>(5) Remove the top panel.</li><li>(6) Remove the screws fixing the cabinet.</li><li>(7) Remove the cabinet.</li><li>(8) Remove the screws fixing the back panel.</li><li>(9) Remove the back panel.</li></ol>	<p><b>Photo 1</b></p>  <p>Screws of the top panel</p> <p>Screws of the top panel</p> <p>Back panel</p> <p>Screws of the back panel</p> <p>Screws of the cabinet</p> <p>Service panel</p> <p><b>Photo 2</b></p>  <p>Screw of the cabinet</p> <p>Screws of the terminal block support and the back panel</p> <p>Screws of the service panel</p> <p>Direction to remove</p> <p>Hooks</p> <p>Screws of the cabinet</p>



**OPERATING PROCEDURE**

**2. Removing the inverter assembly, inverter P.C. board**

- (1) Remove the cabinet and panels. (Refer to section 1.)
- (2) Disconnect the lead wire to the reactor and the following connectors:  
<Inverter P.C. board>  
CN721 (R.V. coil)  
CN931, CN932 (Fan motor)  
CN641 (Defrost thermistor and discharge temperature thermistor)  
CN643 (Ambient temperature thermistor)  
CN644 (Outdoor heat exchanger temperature thermistor)  
CN724 (LEV)
- (3) Remove the compressor connector (CN61).
- (4) Remove the screws fixing the heat sink support and the separator.
- (5) Remove the fixing screws of the terminal block support and the back panel.
- (6) Remove the inverter assembly.
- (7) Remove the screw of the earth wire and screw of the terminal block support.
- (8) Remove the heat sink support from the P.C. board support.
- (9) Remove the screw of the inverter P.C. board and remove the inverter P.C. board from the P.C. board support.

**3. Removing R.V. coil**

- (1) Remove the cabinet and panels. (Refer to section 1.)
- (2) Disconnect the following connectors:  
<Inverter P.C. board>  
CN721 (R.V. coil)
- (3) Remove the R.V. coil.

**4. Removing the discharge temperature thermistor, defrost thermistor, outdoor heat exchanger temperature thermistor and ambient temperature thermistor**

- (1) Remove the cabinet and panels. (Refer to section 1.)
- (2) Disconnect the lead wire to the reactor and the following connectors:  
<Inverter P.C. board>  
CN641 (Defrost thermistor and discharge temperature thermistor)  
CN643 (Ambient temperature thermistor)  
CN644 (Outdoor heat exchanger temperature thermistor)
- (3) Pull out the discharge temperature thermistor from its holder.
- (4) Pull out the defrost thermistor from its holder. (Photo 6)
- (5) Pull out the outdoor heat exchanger temperature thermistor from its holder. (Photo 6)
- (6) Pull out the ambient temperature thermistor from its holder.

**PHOTOS**

**Photo 3**

Screws of the heat sink support and the separator      Screws of the terminal block support and the back panel

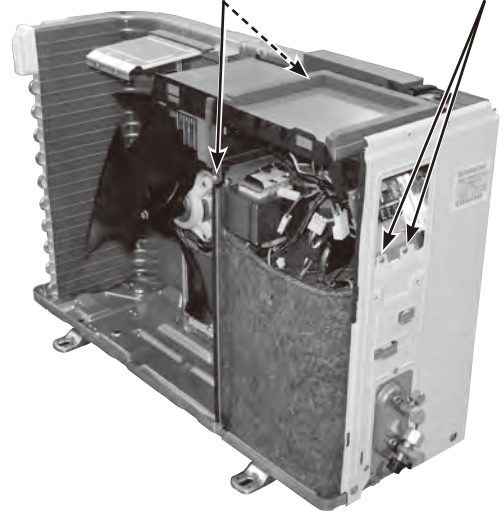

**Photo 4 (Inverter assembly)**

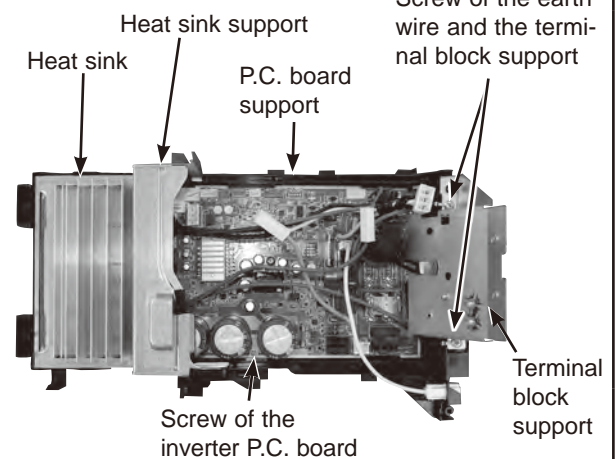

**Photo 5**

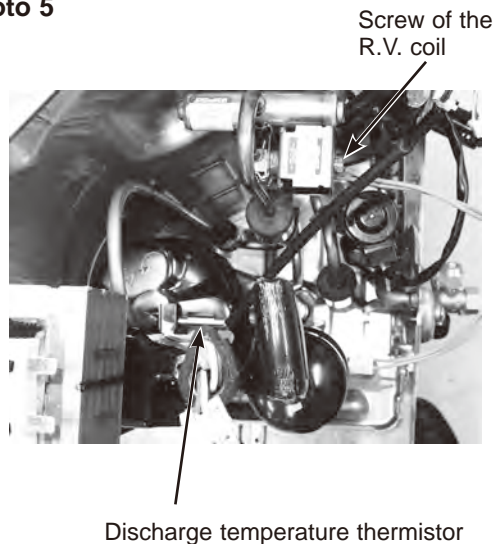

## OPERATING PROCEDURE

### 5. Removing outdoor fan motor

- (1) Remove the cabinet and panels. (Refer to section 1.)
- (2) Disconnect the following connectors:  
<Inverter P.C. board>  
CN931, CN932 (Fan motor)
- (3) Remove the propeller fan nut.
- (4) Remove the propeller fan.
- (5) Remove the screws fixing the fan motor.
- (6) Remove the fan motor.

### 6. Removing the compressor and 4-way valve

- (1) Remove the cabinet and panels. (Refer to section 1.)
- (2) Remove the inverter assembly. (Refer to section 2.)
- (3) Recover gas from the refrigerant circuit.  
**NOTE:** Recover gas from the pipes until the pressure gauge shows 0 kg/cm<sup>2</sup> (0 MPa).
- (4) Detach the brazed part of the suction and the discharge pipe connected with compressor.
- (5) Remove the nuts of compressor legs.
- (6) Remove the compressor.
- (7) Detach the brazed part of pipes connected with 4-way valve.

### 7. Removing the LEV assembly

- (1) Detaching the brazed part of pipes connected with LEV valve.

Photo 9

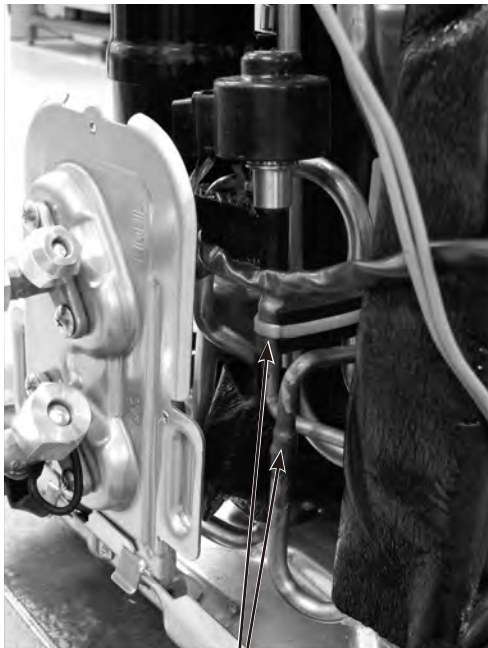

Brazed parts of LEV valve

## PHOTOS

Photo 6

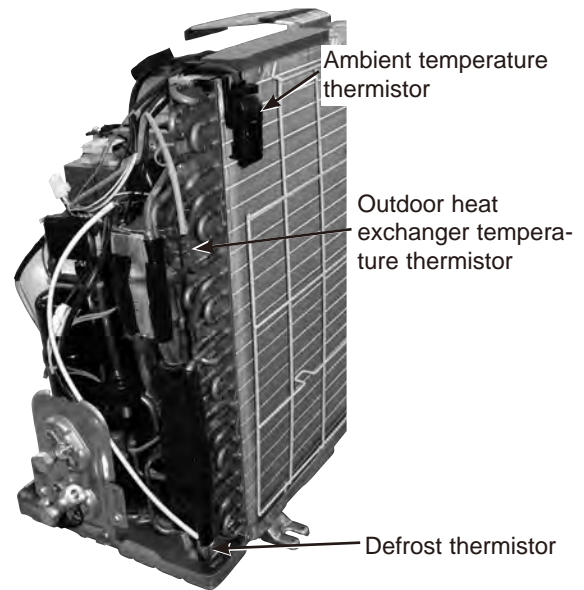

Photo 7

Screws of the outdoor fan motor

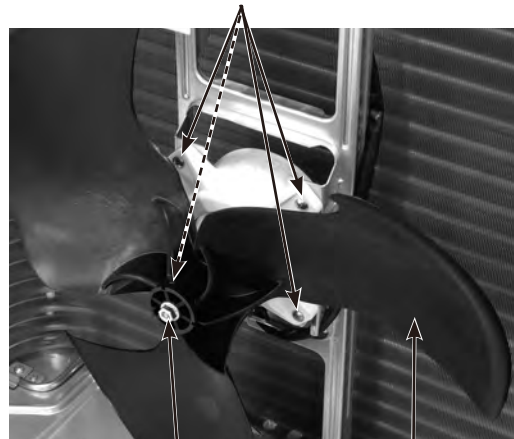
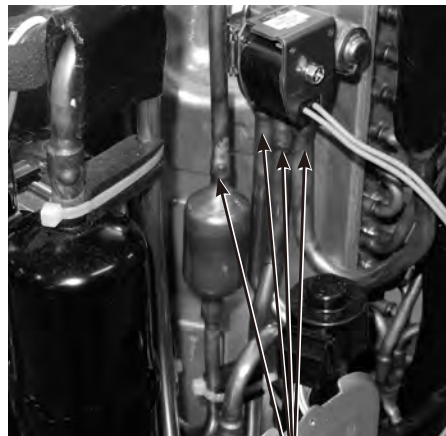

Photo 8

Propeller fan nut

Propeller fan



Brazed parts of 4-way valve



## 13-2. MUZ-HR60VF MUZ-HR71VF

**NOTE:** Turn OFF the power supply before disassembly.

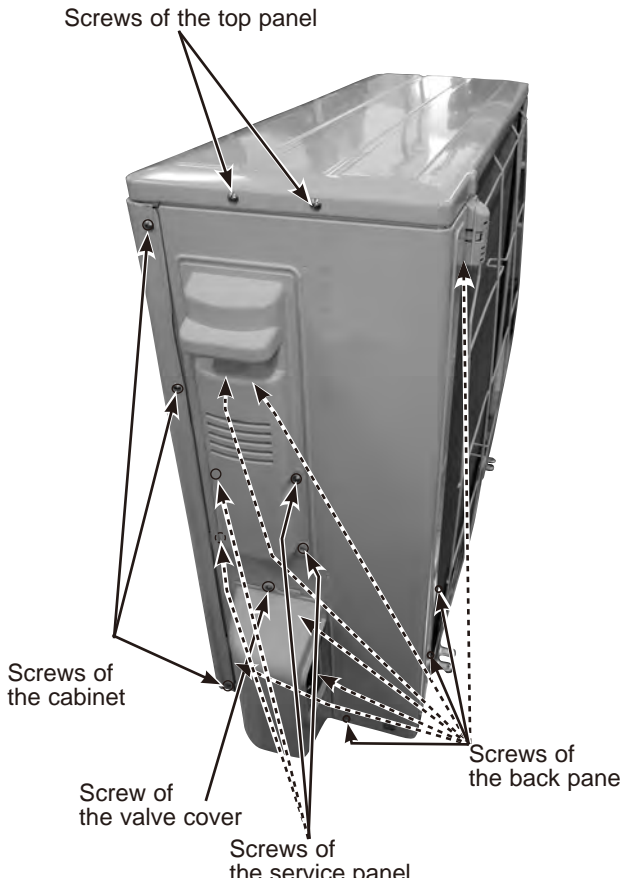
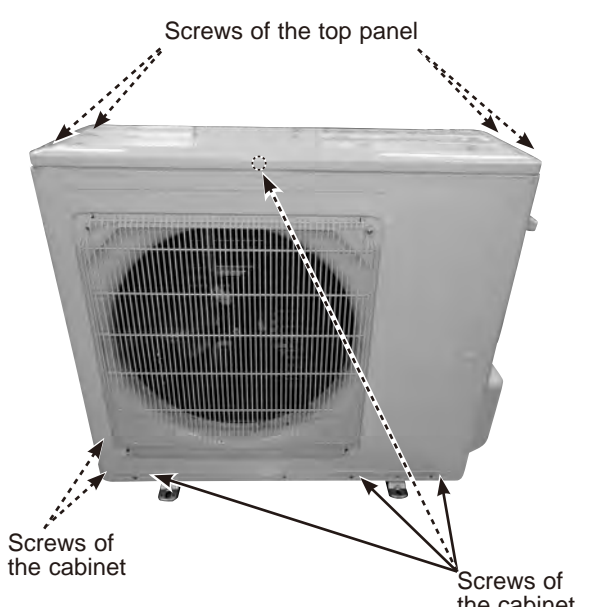
OPERATING PROCEDURE	PHOTOS/FIGURES
<p><b>1. Removing the cabinet</b></p> <ol style="list-style-type: none"><li>(1) Remove the screws of the service panel.</li><li>(2) Remove the screws of the top panel.</li><li>(3) Remove the screw of the valve cover.</li><li>(4) Remove the service panel.</li><li>(5) Remove the top panel.</li><li>(6) Remove the valve cover.</li><li>(7) Disconnect the power supply and indoor/outdoor connecting wire.</li><li>(8) Remove the screws of the cabinet.</li><li>(9) Remove the cabinet.</li><li>(10) Remove the screws of the back panel.</li><li>(11) Remove the back panel.</li></ol> <p><b>Photo 2</b></p>  <p>Screws of the top panel</p> <p>Screws of the cabinet</p> <p>Screw of the valve cover</p> <p>Screws of the service panel</p> <p>Screws of the back panel</p>	<p><b>Photo 1</b></p>  <p>Screws of the top panel</p> <p>Screws of the cabinet</p> <p>Screws of the cabinet</p>

## OPERATING PROCEDURE

### 2. Removing the inverter assembly and inverter P.C. board

- (1) Remove the cabinet and panels. (Refer to section 1.)
- (2) Disconnect the lead wire to the reactor and the following connectors:
  - <Inverter P.C. board>
  - CN721 (R.V. coil)
  - CN931, CN932 (Fan motor)
  - CN641 (Defrost thermistor and discharge temperature thermistor)
  - CN643 (Ambient temperature thermistor)
  - CN644 (Outdoor heat exchanger temperature thermistor)
  - CN724 (LEV)
- (3) Remove the compressor connector (CN61).
- (4) Remove the screws fixing the heat sink support and the separator.
- (5) Remove the fixing screw of the P.B. support and the separator.
- (6) Remove the fixing screws of the terminal block support and the back panel.
- (7) Remove the inverter assembly.
- (8) Remove the heat sink support from the P.C. board support.
- (9) Remove the screw of the inverter P.C. board and remove the inverter P.C. board from the P.C. board support.

#### \* Connection procedure when attaching the inverter P.C. board (Photo 4)

1. Connect the lead wires of the heat exchanger temperature thermistor, the defrost thermistor and discharge temperature thermistor to the connector on the inverter P.C. board. Pull the lead wires toward you and put them on the right hook on the P.C. board support.
2. Connect the lead wires of the LEV to the connector on the inverter P.C. board. Pull the lead wires toward you and put them on the right hook on the P.C. board support.
3. Connect the lead wires of the ambient temperature thermistor to the connector on the inverter P.C. board. Pull the lead wires toward you and put them on the left hook on the P.C. board support so that the fan motor lead wires are bundled up as shown in Photo 4.

## PHOTOS/FIGURES

Photo 3

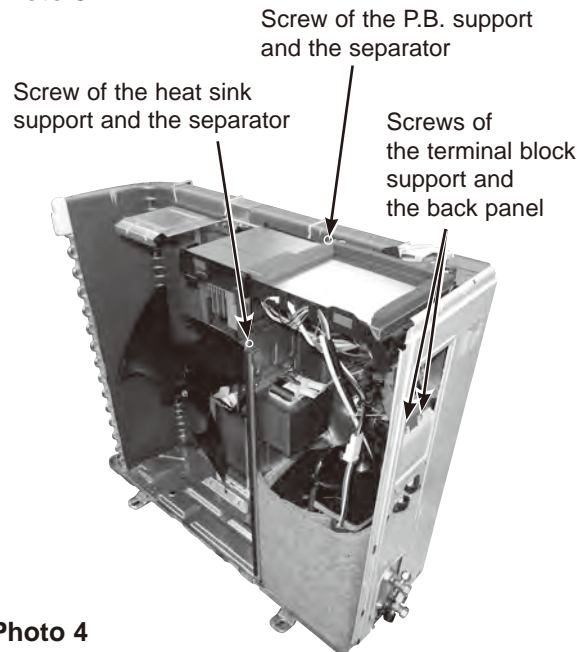

Photo 4

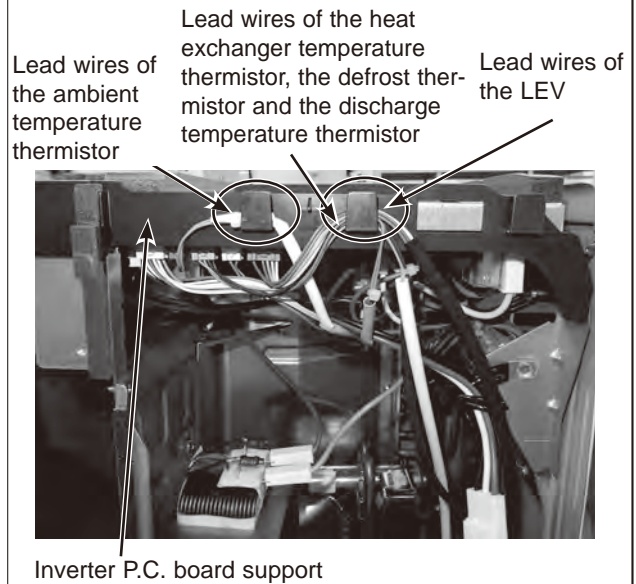
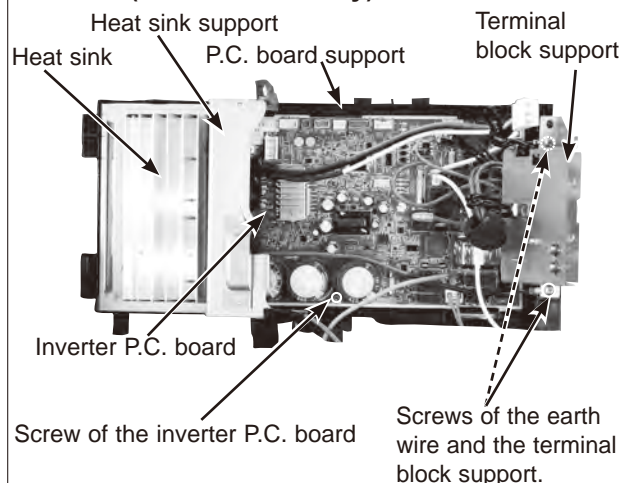

Photo 5 (Inverter assembly)





**OPERATING PROCEDURE**

**3. Removing R. V. coil**

- (1) Remove the cabinet and panels. (Refer to section 1.)
- (2) Disconnect the following connectors:  
<Inverter P.C. board>  
CN721 (R.V. coil)
- (3) Remove the R.V. coil.

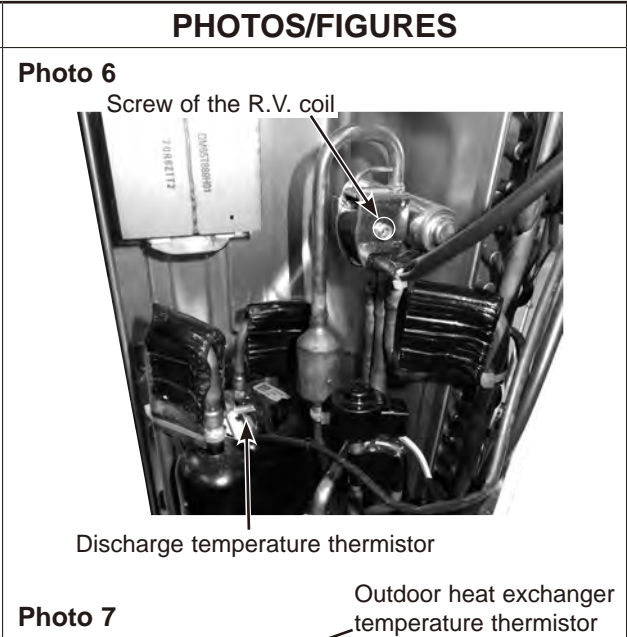

**4. Removing the discharge temperature thermistor, defrost thermistor, outdoor heat exchanger temperature thermistor and ambient temperature thermistor**

- (1) Remove the cabinet and panels. (Refer to section 1.)
- (2) Disconnect the lead wire to the reactor and the following connectors:  
<Inverter P.C. board>  
CN641 (Defrost thermistor and discharge temperature thermistor)  
CN643 (Ambient temperature thermistor)  
CN644 (Outdoor heat exchanger temperature thermistor)
- (3) Pull out the discharge temperature thermistor from its holder.
- (4) Pull out the defrost thermistor from its holder.
- (5) Pull out the outdoor heat exchanger temperature thermistor from its holder.
- (6) Pull out the ambient temperature thermistor from its holder.

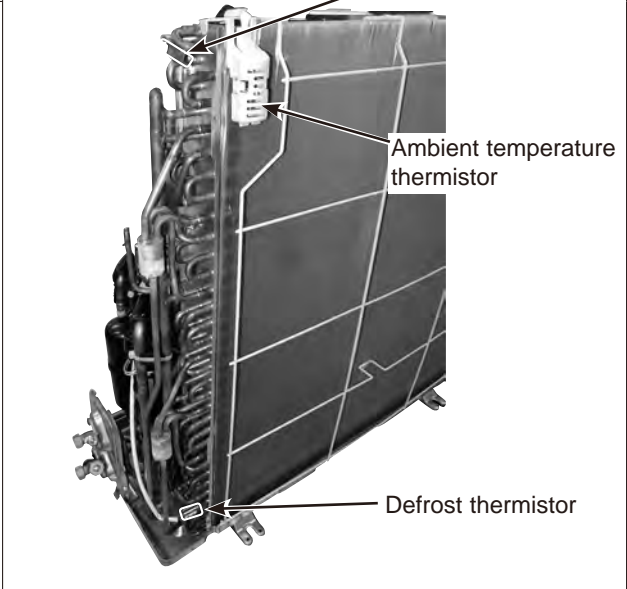

**5. Removing outdoor fan motor**

- (1) Remove the cabinet and panels. (Refer to section 1.)
- (2) Disconnect the following connectors:  
<Inverter P.C. board>  
CN931, CN932 (Fan motor)
- (3) Remove the propeller fan nut.
- (4) Remove the propeller fan.
- (5) Remove the screws fixing the fan motor.
- (6) Remove the fan motor.

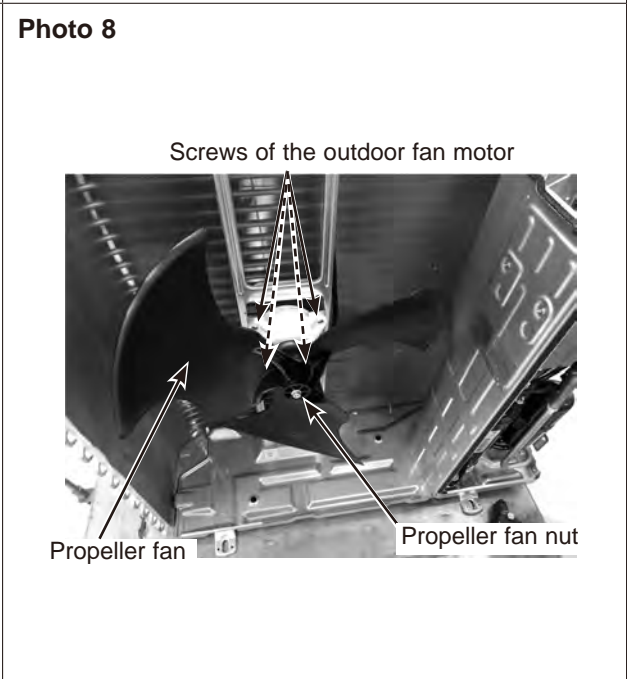

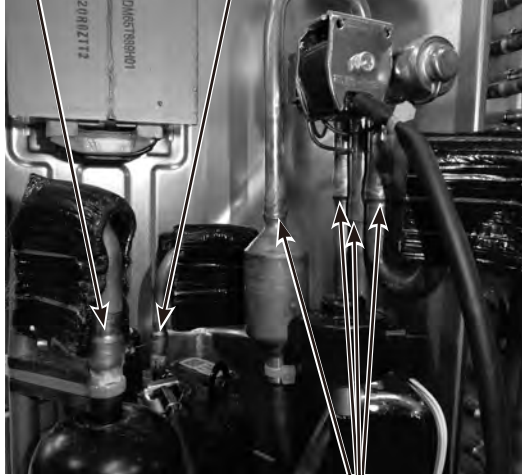

OPERATING PROCEDURE	PHOTOS/FIGURES
<p><b>6. Removing the compressor and 4-way valve</b></p> <p>(1) Remove the cabinet and panels. (Refer to section 1.)</p> <p>(2) Remove the inverter assembly. (Refer to section 2.)</p> <p>(3) Recover gas from the refrigerant circuit.</p> <p><b>NOTE:</b> Recover gas from the pipes until the pressure gauge shows 0 kg/cm<sup>2</sup> (0 MPa).</p> <p>(4) Detach the brazed part of the suction and the discharge pipe connected with compressor.</p> <p>(5) Remove the compressor nuts.</p> <p>(6) Remove the compressor.</p> <p>(7) Detach the brazed part of pipes connected with 4-way valve.</p>	<p><b>Photo 9</b></p> <p>Suction pipe brazed part</p> <p>Discharge pipe brazed part</p>  <p>Brazed parts of 4-way valve</p>

# MITSUBISHI ELECTRIC CORPORATION

HEAD OFFICE: TOKYO BUILDING, 2-7-3, MARUNOUCHI, CHIYODA-KU, TOKYO 100-8310, JAPAN

© Copyright 2018 MITSUBISHI ELECTRIC CORPORATION

Issued: Feb. 2020. No. OBH823 REVISED EDITION-B

Issued: Jan. 2020. No. OBH823 REVISED EDITION-A

Published: Oct. 2018. No. OBH823

Made in Japan

Specifications are subject to change without notice.