

TECHNICAL & SERVICE MANUAL

Series SLZ Ceiling Cassettes R32/R410A

Indoor unit
[Model Name]

[Service Ref.]

SLZ-M15FA

SLZ-M15FA.TH
SLZ-M15FA.TH-ER

SLZ-M25FA

SLZ-M25FA.TH
SLZ-M25FA.TH-ER

SLZ-M35FA

SLZ-M35FA.TH
SLZ-M35FA.TH-ER

SLZ-M50FA

SLZ-M50FA.TH
SLZ-M50FA.TH-ER

SLZ-M60FA

SLZ-M60FA.TH
SLZ-M60FA.TH-ER

Note:

- This manual describes service data of the indoor units only.

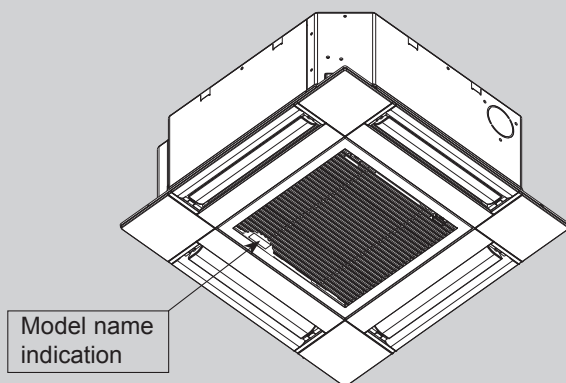

INDOOR UNIT

CONTENTS

1. REFERENCE MANUAL	2
2. SAFETY PRECATION	3
3. PARTS NAMES AND FUNCTIONS.....	9
4. SPECIFICATIONS	14
5. NOISE CRITERION CURVES	14
6. OUTLINES AND DIMENSIONS.....	16
7. WIRING DIAGRAM.....	18
8. REFRIGERANT SYSTEM DIAGRAM	19
9. TROUBLESHOOTING.....	20
10. 4-WAY AIR FLOW SYSTEM.....	33
11. DISASSEMBLY PROCEDURE	35

PARTS CATALOG (OCB522)





Mr. SLIM

OUTDOOR UNIT'S SERVICE MANUAL

Service Ref.	Service Manual No.
MXZ-2D33VA MXZ-2D42VA2 MXZ-2D53VA(H)2	OBH626 OBB626
MXZ-2E53VAHZ MXZ-3E54VA MXZ-3E68VA MXZ-4E72VA MXZ-4E83VAHZ MXZ-4E83VA MXZ-5E102VA	OBH723 OBB723
MXZ-6D122VA2 MXZ-2F33VF* MXZ-2F42VF* MXZ-2F53VF(H)* MXZ-3F54VF* MXZ-3F68VF* MXZ-4F72VF*	OBH626 OBH790
SUZ-KA25VA6 SUZ-KA35VA6 SUZ-KA50VA6 SUZ-KA60VA6	TCB004 TCH004
PUHZ-ZRP71VHA	OCH527 OCB527
PUHZ-ZRP100V/YKA3 PUHZ-ZRP125V/YKA3 PUHZ-ZRP140V/YKA3	OCH645 OCB645

* These outdoor units can be connected to SLZ-M15FA.TH and SLZ-M15FA-ER.TH.

MEANINGS OF SYMBOLS DISPLAYED ON THE UNIT

	WARNING (Risk of fire)	This mark is for R32 refrigerant only. Refrigerant type is written on nameplate of outdoor unit. In case that refrigerant type is R32, this unit uses a flammable refrigerant. If refrigerant leaks and comes in contact with fire or heating part, it will create harmful gas and there is risk of fire.
		Read the OPERATION MANUAL carefully before operation.
		Service personnel are required to carefully read the OPERATION MANUAL and INSTALLATION MANUAL before operation.
		Further information is available in the OPERATION MANUAL, INSTALLATION MANUAL, and the like.

2-1. ALWAYS OBSERVE FOR SAFETY

Before obtaining access to terminal, all supply circuits must be disconnected.

2-2. CAUTIONS RELATED TO NEW REFRIGERANT

Cautions for units utilizing refrigerant R32/R410A

Use new refrigerant pipes.

In case of using the existing pipes for R22, be careful with the following.

- Be sure to clean the pipes and make sure that the insides of the pipes are clean.
- Change flare nut to the one provided with this product. Use a newly flared pipe.
- Avoid using thin pipes.
- In case of reconnecting the refrigerant pipes after detaching, make the flared part of pipe re-fabricated.

Make sure that the inside and outside of refrigerant piping is clean and it has no contaminants such as sulfur, oxides, dirt, shaving particles, etc, which are hazard to refrigerant cycle. In addition, use pipes with specified thickness.

Contamination inside refrigerant piping can cause deterioration of refrigerant oil, etc.

Store the piping indoors, and keep both ends of the piping sealed until just before brazing. (Leave elbow joints, etc. in their packaging.)

If dirt, dust or moisture enters into refrigerant cycle, that can cause deterioration of refrigerant oil or malfunction of compressor.

The refrigerant oil applied to flare and flange connections must be ester oil, ether oil or alkylbenzene oil in a small amount.

If large amount of mineral oil enters, that can cause deterioration of refrigerant oil, etc.

Charge refrigerant from liquid phase of gas cylinder.

If the refrigerant is charged from gas phase, composition change may occur in refrigerant and the efficiency will be lowered.

Use a vacuum pump with a reverse flow check valve.

Vacuum pump oil may flow back into refrigerant cycle and that can cause deterioration of refrigerant oil, etc.

Use the following tools specifically designed for use with R32/R410A refrigerant.

The following tools are necessary to use R32/R410A refrigerant.

Tools for R32/R410A	
Gauge manifold	Flare tool
Charge hose	Size adjustment gauge
Gas leak detector	Vacuum pump adaptor
Torque wrench	Electronic refrigerant charging scale

Handle tools with care.

If dirt, dust or moisture enters into refrigerant cycle, that can cause deterioration of refrigerant oil or malfunction of compressor.

Do not use a charging cylinder.

If a charging cylinder is used, the composition of refrigerant will change and the efficiency will be lowered.

Use the specified refrigerant only.

Never use any refrigerant other than that specified.

Doing so may cause a burst, an explosion, or fire when the unit is being used, serviced, or disposed of.

Correct refrigerant is specified on name plate of outdoor unit.

If other refrigerant (R22, etc.) is used, chlorine in refrigerant can cause deterioration of refrigerant oil, etc.

We will not be held responsible for mechanical failure, system malfunction, unit breakdown or accidents caused by failure to follow the instructions.

Ventilate the room if refrigerant leaks during operation. If refrigerant comes into contact with a flame, poisonous gases will be released.

[1] Warning for service

- (1) Do not alter the unit.
- (2) For installation and relocation work, follow the instructions in the Installation Manual and use tools and pipe components specifically made for use with refrigerant specified in the outdoor unit installation manual.
- (3) Ask a dealer or an authorized technician to install, relocate and repair the unit.
- (4) This unit should be installed in rooms which exceed the floor space specified in outdoor unit installation manual. Refer to outdoor unit installation manual.
- (5) Install the indoor unit at least 2.5 m above floor or grade level.
For appliances not accessible to the general public.
- (6) Refrigerant pipes connection shall be accessible for maintenance purposes.
- (7) If the air conditioner is installed in a small room or closed room, measures must be taken to prevent the refrigerant concentration in the room from exceeding the safety limit in the event of refrigerant leakage. Should the refrigerant leak and cause the concentration limit to be exceeded, hazards due to lack of oxygen in the room may result.
- (8) Keep gas-burning appliances, electric heaters, and other fire sources (ignition sources) away from the location where installation, repair, and other air conditioner work will be performed.
If refrigerant comes into contact with a flame, poisonous gases will be released.
- (9) When installing or relocating, or servicing the air conditioner, use only the specified refrigerant written on outdoor unit to charge the refrigerant lines.
Do not mix it with any other refrigerant and do not allow air to remain in the lines.
If air is mixed with the refrigerant, then it can be the cause of abnormal high pressure in the refrigerant line, and may result in an explosion and other hazards.
- (10) After installation has been completed, check for refrigerant leaks. If refrigerant leaks into the room and comes into contact with the flame of a heater or portable cooking range, poisonous gases will be released.
- (11) Do not use low temperature solder alloy in case of brazing the refrigerant pipes.
- (12) When performing brazing work, be sure to ventilate the room sufficiently. Make sure that there are no hazardous or flammable materials nearby.
When performing the work in a closed room, small room, or similar location, make sure that there are no refrigerant leaks before performing the work.
If refrigerant leaks and accumulates, it may ignite or poisonous gases may be released.
- (13) Do not install the unit in places where refrigerant may build-up or places with poor ventilation such as a semi-basement or a sunken place in outdoor: Refrigerant is heavier than air, and inclined to fall away from the leak source.
- (14) Do not use means to accelerate the defrosting process or to clean, other than those recommended by the manufacturer.
- (15) The appliance shall be stored in a room without continuously operating ignition sources (for example: open flames, an operating gas appliance or an operating electric heater).
- (16) Do not pierce or burn.
- (17) Be aware that refrigerants may not contain an odour.
- (18) Pipe-work shall be protected from physical damage.
- (19) The installation of pipe-work shall be kept to a minimum.
- (20) Compliance with national gas regulations shall be observed.
- (21) Keep any required ventilation openings clear of obstruction.
- (22) Servicing shall be performed only as recommended by the manufacturer.
- (23) The appliance shall be stored in a well-ventilated area where the room size corresponds to the room area as specified for operation.
- (24) Maintenance, service and repair operations shall be performed by authorized technician with required qualification.

[2] Cautions for service

- (1) Perform service after recovering the refrigerant left in unit completely.
- (2) Do not release refrigerant in the air.
- (3) After completing service, charge the cycle with specified amount of refrigerant.
- (4) When performing service, install a filter drier simultaneously.
Be sure to use a filter drier for new refrigerant.

[3] Additional refrigerant charge

When charging directly from cylinder

- (1) Check that cylinder for R32/R410A available on the market is a syphon type.
- (2) Charging should be performed with the cylinder of syphon stood vertically. (Refrigerant is charged from liquid phase.)

[4] Cautions for unit using R32 refrigerant

Basic work procedures are the same as those for conventional units using refrigerant R410A. However, pay careful attention to the following points.

(1) Information on servicing

(1-1) Checks on the Area

Prior to beginning work on systems containing flammable refrigerants, safety checks are necessary to ensure that the risk of ignition is minimized.

For repair to the refrigerating systems, (1-3) to (1-7) shall be completed prior to conducting work on the systems.

(1-2) Work Procedure

Work shall be undertaken under a controlled procedure so as to minimize the risk of a flammable gas or vapor being present while the work is being performed.

(1-3) General Work Area

All maintenance staff and others working in the local area shall be instructed on the nature of work being carried out.

Work in confined spaces shall be avoided. The area around the workspace shall be sectioned off. Ensure that the conditions within the area have been made safe by control of flammable material.

(1-4) Checking for Presence of Refrigerant

The area shall be checked with an appropriate refrigerant detector prior to and during work, to ensure the technician is aware of potentially toxic or flammable atmospheres. Ensure that the leak detection equipment being used is suitable for use with all applicable refrigerants, i.e. non-sparking, adequately sealed or intrinsically safe.

(1-5) Presence of Fire Extinguisher

If any hot work is to be conducted on the refrigeration equipment or any associated parts, appropriate fire extinguishing equipment shall be available to hand.

Have a dry powder or CO₂ fire extinguisher adjacent to the charging area.

(1-6) No Ignition Sources

No person carrying out work in relation to a refrigeration system which involves exposing any pipe work shall use any sources of ignition in such a manner that it may lead to the risk of fire or explosion. All possible ignition sources, including cigarette smoking, should be kept sufficiently far away from the site of installation, repairing, removing and disposal, during which refrigerant can possibly be released to the surrounding space. Prior to work taking place, the area around the equipment is to be surveyed to make sure that there are no flammable hazards or ignition risks. "No Smoking" signs shall be displayed.

(1-7) Ventilated Area

Ensure that the area is in the open or that it is adequately ventilated before breaking into the system or conducting any hot work. A degree of ventilation shall continue during the period that the work is carried out. The ventilation should safely disperse any released refrigerant and preferably expel it externally into the atmosphere.

(1-8) Checks on the Refrigeration Equipment

Where electrical components are being changed, they shall be fit for the purpose and to the correct specification. At all times the manufacturer's maintenance and service guidelines shall be followed. If in doubt, consult the manufacturer's technical department for assistance.

The following checks shall be applied to installations using flammable refrigerants:

- The charge size is in accordance with the room size within which the refrigerant containing parts are installed.
- The ventilation machinery and outlets are operating adequately and are not obstructed.
- Marking to the equipment continues to be visible and legible. Markings and signs that are illegible shall be corrected.
- Refrigeration pipe or components are installed in a position where they are unlikely to be exposed to any substance which may corrode refrigerant containing components, unless the components are constructed of materials which are inherently resistant to being corroded or are suitably protected against being corroded.

(1-9) Checks on Electrical Devices

Repair and maintenance to electrical components shall include initial safety checks and component inspection procedures. If a fault exists that could compromise safety, then no electrical supply shall be connected to the circuit until it is satisfactorily dealt with. If the fault cannot be corrected immediately but it is necessary to continue operation, an adequate temporary solution shall be used. This shall be reported to the owner of the equipment so all parties are advised.

Initial safety checks shall include that:

- capacitors are discharged: this shall be done in a safe manner to avoid possibility of sparking;
- no live electrical components and wiring are exposed while charging, recovering or purging the system;
- there is continuity of earth bonding

(2) Repairs to Sealed Components

(2-1) During repairs to sealed components, all electrical supplies shall be disconnected from the equipment being worked upon prior to any removal of sealed covers, etc. If it is absolutely necessary to have an electrical supply to equipment during servicing, then a permanently operating form of leak detection shall be located at the most critical point to warn of a potentially hazardous situation.

(2-2) Particular attention shall be paid to the following to ensure that by working on electrical components, the casing is not altered in such a way that the level of protection is affected. This shall include damage to cables, excessive number of connections, terminals not made to original specification, damage to seals, incorrect fitting of glands, etc.

Ensure that the apparatus is mounted securely.

Ensure that seals or sealing materials have not degraded to the point that they no longer serve the purpose of preventing the ingress of flammable atmospheres.

Replacement parts shall be in accordance with the manufacturer's specifications.

(3) Repair to intrinsically Safe Components

Do not apply any permanent inductive or capacitance loads to the circuit without ensuring that this will not exceed the permissible voltage and current permitted for the equipment in use.

Intrinsically safe components are the only types that can be worked on while live in the presence of a flammable atmosphere. The test apparatus shall be at the correct rating.

Replace components only with parts specified by the manufacturer. Other parts may result in the ignition of refrigerant in the atmosphere from a leak.

(4) Cabling

Check that cabling will not be subject to wear, corrosion, excessive pressure, vibration, sharp edges or any other adverse environmental effects. The check shall also take into account the effects of aging or continual vibration from sources such as compressors or fans.

(5) Detection of Flammable Refrigerants

Under no circumstances shall potential sources of ignition be used in the searching for or detection of refrigerant leaks.

A halide torch (or any other detector using a naked flame) shall not be used.

(6) Leak Detection Methods

Electronic leak detectors may be used to detect refrigerant leaks but, in the case of flammable refrigerants, the sensitivity may not be adequate, or may need re-calibration. (Detection equipment shall be calibrated in a refrigerant-free area.)

Ensure that the detector is not a potential source of ignition and is suitable for the refrigerant used. Leak detection equipment shall be set at a percentage of the LFL of the refrigerant and shall be calibrated to the refrigerant employed, and the appropriate percentage of gas (25% maximum) is confirmed.

Leak detection fluids are suitable for use with most refrigerants but the use of detergents containing chlorine shall be avoided as the chlorine may react with the refrigerant and corrode the copper pipe-work.

If a leak is suspected, all naked flames shall be removed/extinguished.

If a leakage of refrigerant is found which requires brazing, all of the refrigerant shall be recovered from the system, or isolated (by means of shut off valves) in a part of the system remote from the leak. For appliances containing flammable refrigerants, oxygen free nitrogen (OFN) shall then be purged through the system both before and during the brazing process.

(7) Removal and Evacuation

When breaking into the refrigerant circuit to make repairs – or for any other purpose conventional procedures shall be used. However, for flammable refrigerants it is important that best practice is followed since flammability is a consideration. The following procedure shall be adhered to:

- remove refrigerant
- purge the circuit with inert gas
- evacuate
- purge again with inert gas
- open the circuit by cutting or brazing.

The refrigerant charge shall be recovered into the correct recovery cylinders. For appliances containing flammable refrigerants, the system shall be “flushed” with OFN to render the unit safe. This process may need to be repeated several times.

Compressed air or oxygen shall not be used for purging refrigerant systems.

For appliances containing flammable refrigerants, flushing shall be achieved by breaking the vacuum in the system with OFN and continuing to fill until the working pressure is achieved, then venting to atmosphere, and finally pulling down to a vacuum. This process shall be repeated until no refrigerant is within the system. When the final OFN charge is used, the system shall be vented down to atmospheric pressure to enable work to take place. This operation is absolutely vital if brazing operations on the pipe-work are to take place.

Ensure that the outlet for the vacuum pump is not close to any ignition sources and that ventilation is available.

(8) Charging Procedures

In addition to conventional charging procedures, the following requirements shall be followed:

- Ensure that contamination of different refrigerants does not occur when using charging equipment. Hoses or lines shall be as short as possible to minimize the amount of refrigerant contained in them.
- Cylinders shall be kept upright.
- Ensure that the refrigeration system is earthed prior to charging the system with refrigerant.
- Label the system when charging is complete (if not already).
- Extreme care shall be taken not to overfill the refrigeration system.

Prior to recharging the system, it shall be pressure-tested with the appropriate purging gas. The system shall be leak-tested on completion of charging but prior to commissioning. A follow up leak test shall be carried out prior to leaving the site.

(9) Decommissioning

Before carrying out this procedure, it is essential that the technician is completely familiar with the equipment and all its detail. It is recommended good practice that all refrigerants are recovered safely. Prior to the task being carried out, an oil and refrigerant sample shall be taken in case analysis is required prior to re-use of reclaimed refrigerant. It is essential that electrical power is available before the task is commenced.

Continued to the next page

- a) Become familiar with the equipment and its operation.
- b) Isolate system electrically.
- c) Before attempting the procedure, ensure that:
 - mechanical handling equipment is available, if required, for handling refrigerant cylinders;
 - all personal protective equipment is available and being used correctly;
 - the recovery process is supervised at all times by a competent person;
 - recovery equipment and cylinders conform to the appropriate standards.
- d) Pump down refrigerant system, if possible.
- e) If a vacuum is not possible, make a manifold so that refrigerant can be removed from various parts of the system.
- f) Make sure that cylinder is situated on the scales before recovery takes place.
- g) Start the recovery machine and operate in accordance with manufacturer's instructions.
- h) Do not overfill cylinders. (No more than 80 % volume liquid charge).
- i) Do not exceed the maximum working pressure of the cylinder, even temporarily.
- j) When the cylinders have been filled correctly and the process completed, make sure that the cylinders and the equipment are removed from site promptly and all isolation valves on the equipment are closed off.
- k) Recovered refrigerant shall not be charged into another refrigeration system unless it has been cleaned and checked.

(10) Labelling

Equipment shall be labelled stating that it has been de-commissioned and emptied of refrigerant. The label shall be dated and signed. For appliances containing flammable refrigerants, ensure that there are labels on the equipment stating the equipment contains flammable refrigerant.

(11) Recovery

When removing refrigerant from a system, either for servicing or decommissioning, it is recommended good practice that all refrigerants are removed safely. When transferring refrigerant into cylinders, ensure that only appropriate refrigerant recovery cylinders are employed. Ensure that the correct number of cylinders for holding the total system charge are available. All cylinders to be used are designated for the recovered refrigerant and labelled for that refrigerant (i.e. special cylinders for the recovery of refrigerant). Cylinders shall be complete with pressure-relief valve and associated shut-off valves in good working order. Empty recovery cylinders are evacuated and, if possible, cooled before recovery occurs.

The recovery equipment shall be in good working order with a set of instructions concerning the equipment that is at hand and shall be suitable for the recovery of all appropriate refrigerants including, when applicable, flammable refrigerants. In addition, a set of calibrated weighing scales shall be available and in good working order. Hoses shall be complete with leak-free disconnect couplings and in good condition. Before using the recovery machine, check that it is in satisfactory working order, has been properly maintained and that any associated electrical components are sealed to prevent ignition in the event of a refrigerant release. Consult manufacturer if in doubt.

The recovered refrigerant shall be returned to the refrigerant supplier in the correct recovery cylinder, and the relevant waste transfer note arranged. Do not mix refrigerants in recovery units and especially not in cylinders. If compressors or compressor oils are to be removed, ensure that they have been evacuated to an acceptable level to make certain that flammable refrigerant does not remain within the lubricant. The evacuation process shall be carried out prior to returning the compressor to the suppliers. Only electric heating to the compressor body shall be employed to accelerate this process. When oil is drained from a system, it shall be carried out safely.

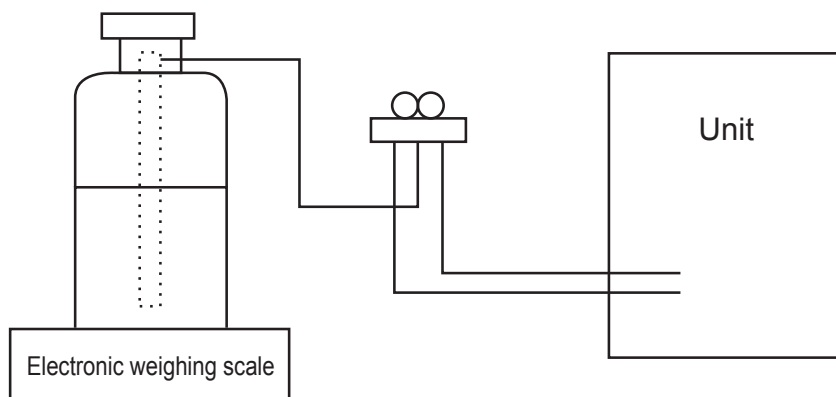

[5] Service tools

Use the below service tools as exclusive tools for R32/R410A refrigerant.

Refer to the spec name plate on outdoor unit for the type of refrigerant being used.

No.	Tool name	Specifications
1.	Gauge manifold	<ul style="list-style-type: none"> · Use the existing fitting specifications. (UNF1/2) · Use high-tension side pressure of 5.3MPa-G or over.
2.	Charge hose	<ul style="list-style-type: none"> · Use pressure performance of 5.09MPa-G or over.
3.	Electronic weighing scale	—
4.	Gas leak detector	<ul style="list-style-type: none"> · Use the detector for R134a, R407, R410A, or R32.
5.	Adaptor for reverse flow check	<ul style="list-style-type: none"> · Attach on vacuum pump.
6.	Refrigerant charge base	—
7.	Refrigerant cylinder	<ul style="list-style-type: none"> · R32 or R410A refrigerant · Cylinder with syphon
8.	Refrigerant recovery equipment	—

3

PARTS NAMES AND FUNCTIONS

3-1. INDOOR UNIT

Horizontal Air Outlet

Sets horizontal airflow automatically during cooling or dehumidifying.

Filter

Removes dust and pollutants from drawn in air.

Grille

Auto Air Swing Vane

Disperses airflow up and down and adjusts the angle of airflow direction.

Air Intake

Draws in air from room.

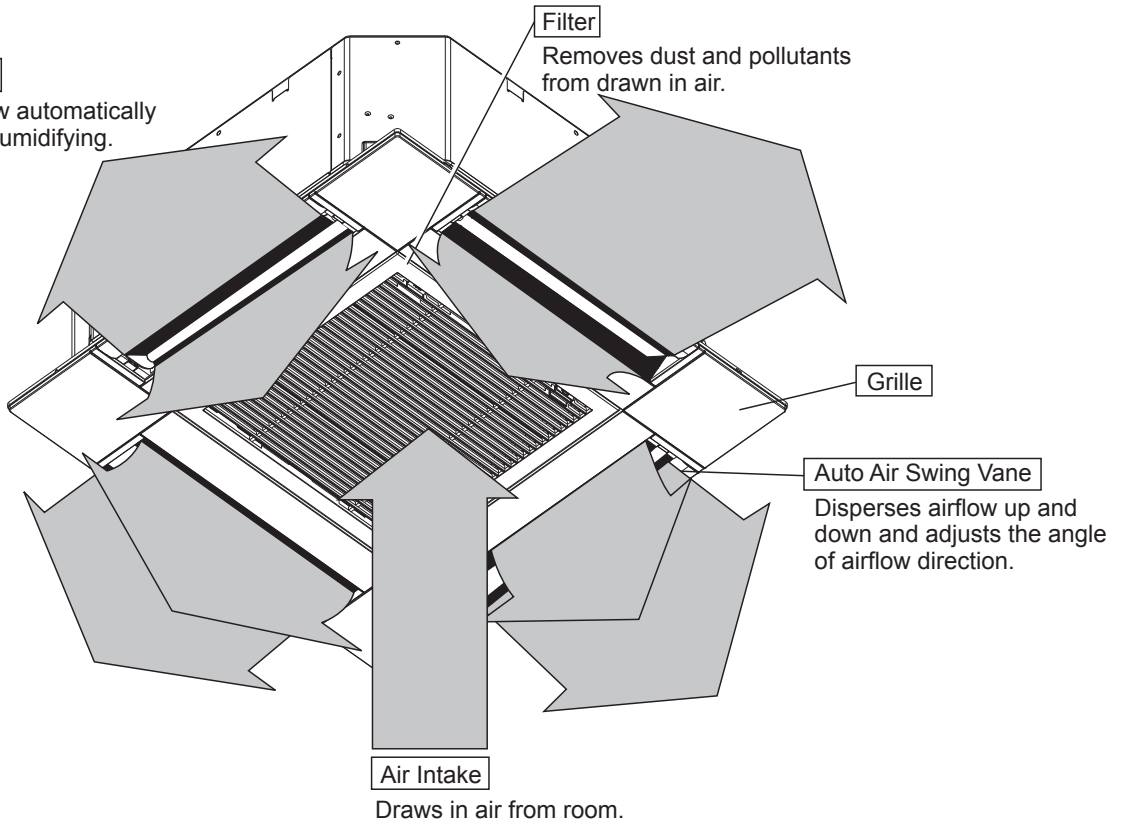

3-2. WIRELESS REMOTE CONTROLLER

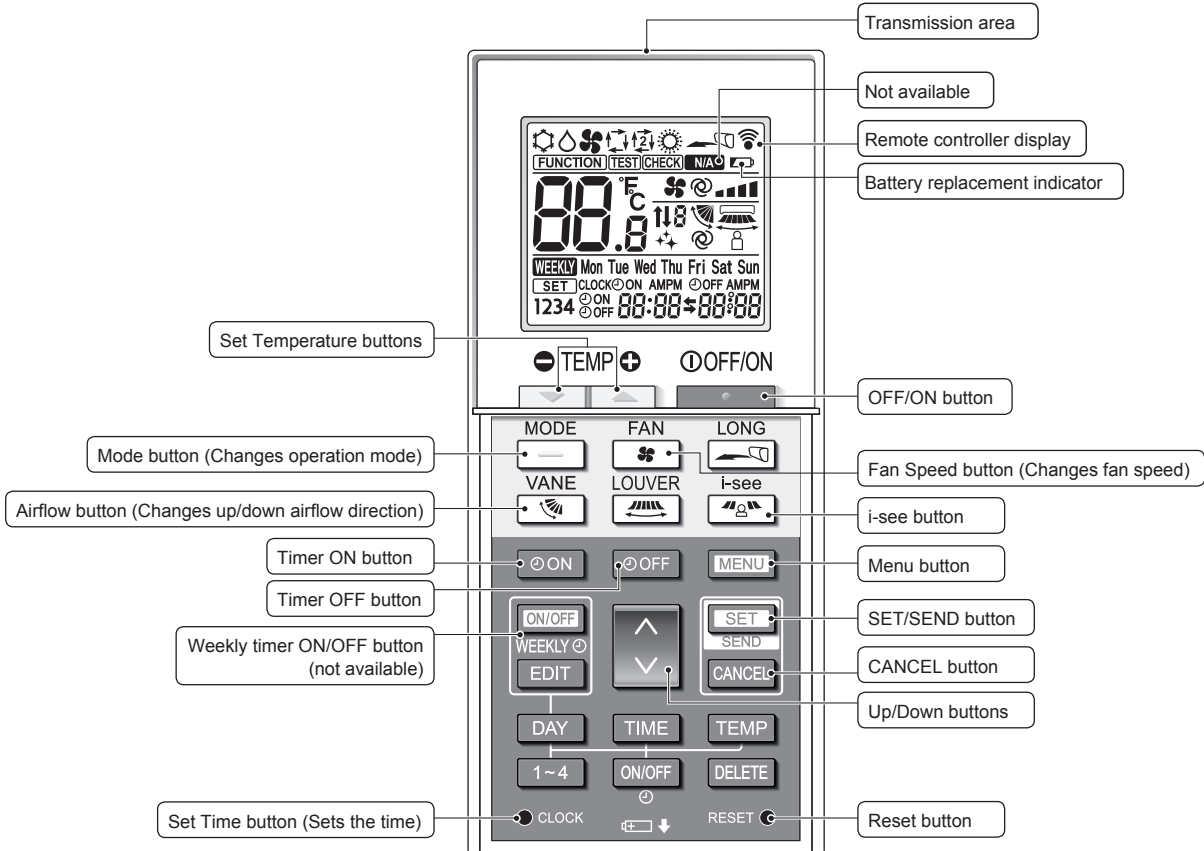

Operation mode

	Cool		Dry
	Fan		Auto
	Heat		

Temperature setting

The units of temperature can be changed. For details, refer to the Installation Manual.

Vane setting

Step 1 Step 2 Step 3 Step 4 Step 5 Swing Auto

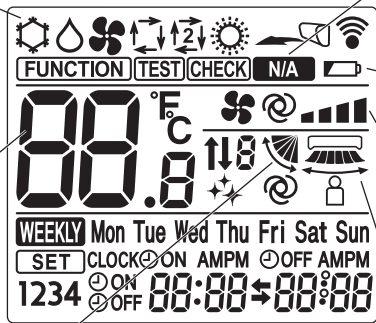

Not available

Appears when a non-supported function is selected.

Battery replacement indicator

Appears when the remaining battery power is low.

Fan speed setting

3D i-see Sensor (Air distribution)

Default Direct Indirect

When Direct or Indirect is selected, the vane setting is set to "Auto".

3-3. Wired remote controller (Option) PAR-33MAA

The functions which can be used are restricted according to each model.

Display

The main display can be displayed in 2 different modes: "Full" and "Basic."
The initial setting is "Full."

Full mode

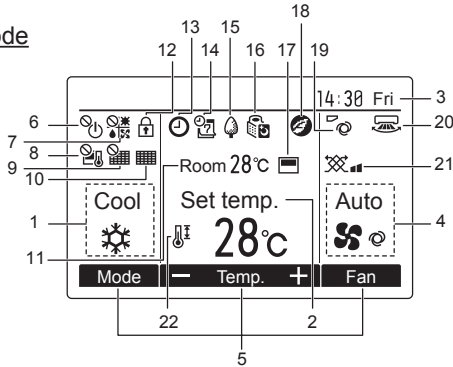

Basic mode

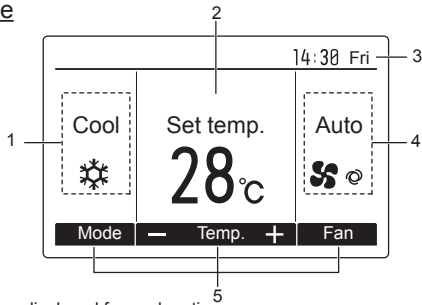

Note: All icons are displayed for explanation.

- 1 Operation mode**
Indoor unit operation mode appears here.
- 2 Preset temperature**
Preset temperature appears here.
- 3 Clock (See the Installation Manual.)**
Current time appears here.
- 4 Fan speed**
Fan speed setting appears here.
- 5 Button function guide**
Functions of the corresponding buttons appear here.
- 6**
Appears when the ON/OFF operation is centrally controlled.
- 7**
Appears when the operation mode is centrally controlled.
- 8**
Appears when the preset temperature is centrally controlled.
- 9**
Appears when the filter reset function is centrally controlled.
- 10**
Indicates when filter needs maintenance.
- 11 Room temperature (See the Installation Manual.)**
Current room temperature appears here.
- 12**
Appears when the buttons are locked.
- 13**
Appears when the On/Off timer or Night setback function is enabled.
- 14**
Appears when the Weekly timer is enabled.
- 15**
Appears while the units are operated in the energy-save mode.
- 16**
Appears while the outdoor units are operated in the silent mode.
- 17**
Appears when the built-in thermistor on the remote controller is activated to monitor the room temperature (a).
Appears when the thermistor on the indoor unit is activated to monitor the room temperature.
- 18**
Appears when the units are operated in the energy-save mode with 3D i-see Sensor.
- 19**
Indicates the vane setting.
- 20**
Indicates the louver setting.
- 21**
Indicates the ventilation setting.
- 22**
Appears when the preset temperature range is restricted.

Controller interface

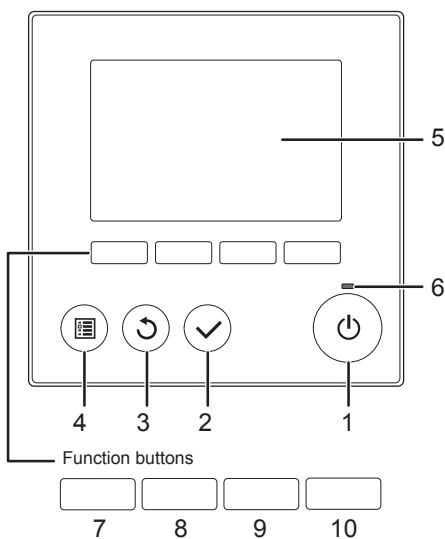

- When the backlight is off, pressing any button turns the backlight on and does not perform its function. (except for the ON/OFF button)
- Most settings (except ON/OFF, mode, fan speed, temperature) can be made from the Menu screen.

- 1 ON/OFF button**
Press to turn ON/OFF the indoor unit.
 - 2 SELECT button**
Press to save the setting.
 - 3 RETURN button**
Press to return to the previous screen.
 - 4 MENU button**
Press to bring up the Main menu.
 - 5 Backlit LCD**
Operation settings will appear. When the backlight is off, pressing any button turns the backlight on and it will stay lit for a certain period of time depending on the screen.
 - 6 ON/OFF lamp**
This lamp lights up in green while the unit is in operation. It blinks while the remote controller is starting up or when there is an error.
- The functions of the function buttons change depending on the screen. Refer to the button function guide that appears at the bottom of the LCD for the functions they serve on a given screen. When the system is centrally controlled, the button function guide that corresponds to the locked button will not appear.
- Main display**

Main menu
- Function guide
- 7 Function button [F1]**
Main display: Press to change the operation mode.
Main menu: Press to move the cursor down.
 - 8 Function button [F2]**
Main display: Press to decrease temperature.
Main menu: Press to move the cursor up.
 - 9 Function button [F3]**
Main display: Press to increase temperature.
Main menu: Press to go to the previous page.
 - 10 Function button [F4]**
Main display: Press to change the fan speed.
Main menu: Press to go to the next page.

Menu structure

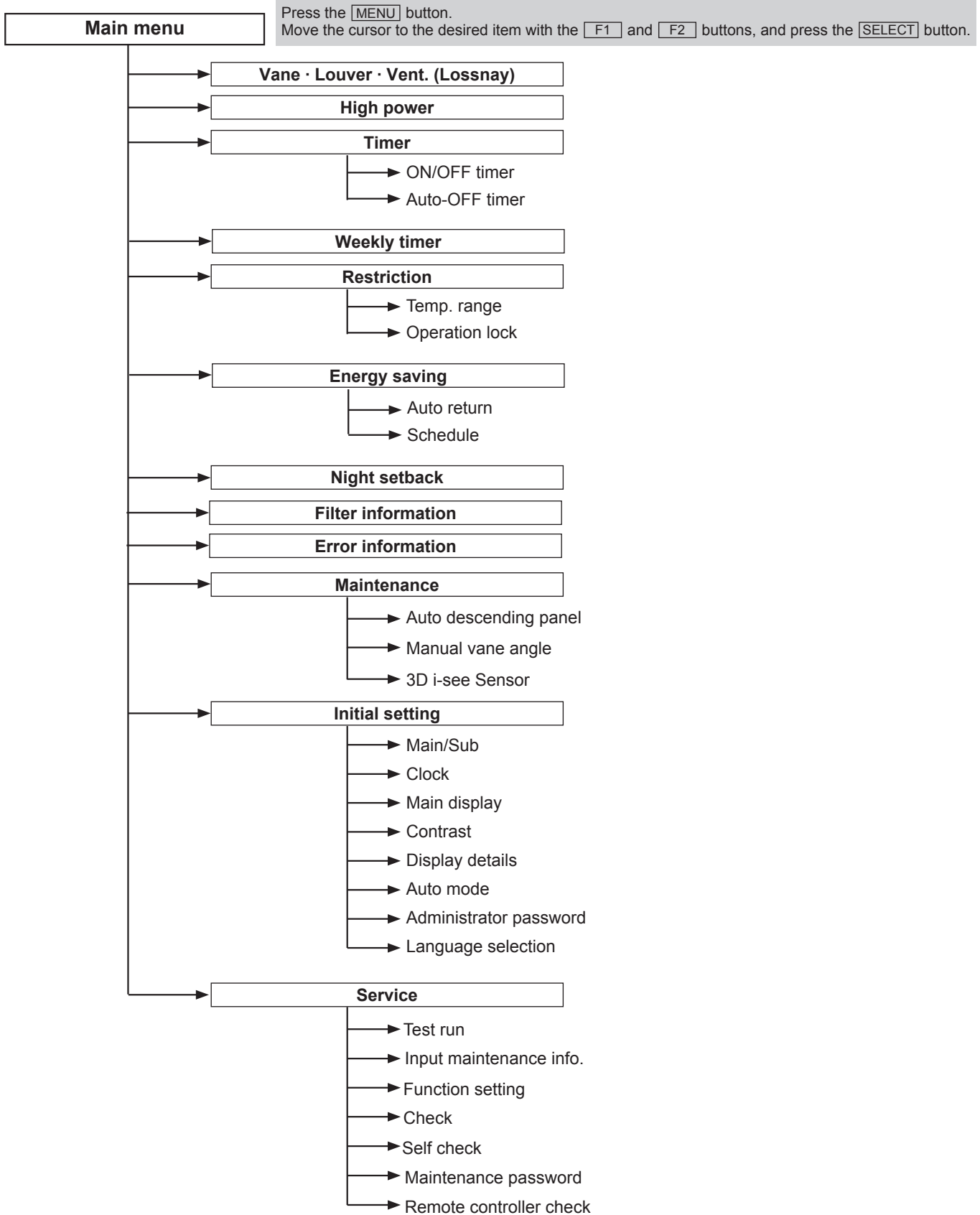

Not all functions are available on all models of indoor units.

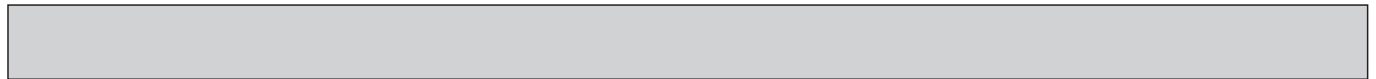

Main menu list

Setting and display items		Setting details
Vane · Louver · Vent. (Lossnay)		<p>Use to set the vane angle.</p> <ul style="list-style-type: none"> • Select a desired vane setting from 5 different settings. <p>Use to turn ON/OFF the louver.</p> <ul style="list-style-type: none"> • Select a desired setting from "ON" and "OFF." <p>Use to set the amount of ventilation.</p> <ul style="list-style-type: none"> • Select a desired setting from "OFF," "Low," and "High."
High power**		<p>Use to reach the comfortable room temperature quickly.</p> <ul style="list-style-type: none"> • Units can be operated in the High-power mode for up to 30 minutes.
Timer	ON/OFF timer*	<p>Use to set the operation ON/OFF times.</p> <ul style="list-style-type: none"> • Time can be set in 5-minute increments.
	Auto-Off timer	<p>Use to set the Auto-OFF time.</p> <ul style="list-style-type: none"> • Time can be set to a value from 30 to 240 in 10-minute increments.
Filter information		<p>Use to check the filter status.</p> <ul style="list-style-type: none"> • The filter sign can be reset.
Error information		<p>Use to check error information when an error occurs.</p> <ul style="list-style-type: none"> • Check code, error source, refrigerant address, unit model, manufacturing number, contact information (dealer's phone number) can be displayed. (The unit model, manufacturing number, and contact information need to be registered in advance to be displayed.)
Weekly timer*		<p>Use to set the weekly operation ON/OFF times.</p> <ul style="list-style-type: none"> • Up to 8 operation patterns can be set for each day. (Not valid when the ON/OFF timer is enabled.)
Energy saving	Auto return	<p>Use to get the units to operate at the preset temperature after performing energy-save operation for a specified time period.</p> <ul style="list-style-type: none"> • Time can be set to a value from 30 and 120 in 10-minute increments. (This function will not be valid when the preset temperature ranges are restricted.)
	Schedule*	<p>Set the start/stop times to operate the units in the energy-save mode for each day of the week, and set the energy-saving rate.</p> <ul style="list-style-type: none"> • Up to 4 energy-save operation patterns can be set for each day. • Time can be set in 5-minute increments. • Energy-saving rate can be set to a value from 0% and 50 to 90% in 10% increments.
Night setback*		<p>Use to make Night setback settings.</p> <ul style="list-style-type: none"> • Select "Yes" to enable the setting, and "No" to disable the setting. The temperature range and the start/stop times can be set.
Restriction	Temp. range	<p>Use to restrict the preset temperature range.</p> <ul style="list-style-type: none"> • Different temperature ranges can be set for different operation modes.
	Operation lock	<p>Use to lock selected functions.</p> <ul style="list-style-type: none"> • The locked functions cannot be operated.
Maintenance	Auto descending panel	Auto descending panel (Optional parts) UP/DOWN you can do.
	Manual vane angle	Use to set the vane angle for each vane to a fixed position.
	3D i-see Sensor	<p>Use to set the following functions for 3D i-see Sensor.</p> <ul style="list-style-type: none"> • Air distribution • Energy saving option • Seasonal airflow
Initial setting	Main/Sub	When connecting 2 remote controllers, one of them needs to be designated as a sub controller.
	Clock	Use to set the current time.
	Main display	<p>Use to switch between "Full" and "Basic" modes for the Main display.</p> <ul style="list-style-type: none"> • The initial setting is "Full."
	Contrast	Use to adjust screen contrast.
Initial setting	Display details	<p>Make the settings for the remote controller related items as necessary.</p> <p>Clock: The initial settings are "Yes" and "24h" format. Temperature: Set either Celsius (°C) or Fahrenheit (°F). Room temp. : Set Show or Hide. Auto mode: Set the Auto mode display or Only Auto display.</p>
	Auto mode	<p>Whether or not to use the AUTO mode can be selected by using the button.</p> <p>This setting is valid only when indoor units with the AUTO mode function are connected.</p>
	Administrator password	<p>The administrator password is required to make the settings for the following items.</p> <ul style="list-style-type: none"> • Timer setting • Energy-save setting • Weekly timer setting • Restriction setting • Outdoor unit silent mode setting • Night set back
	Language selection	Use to select the desired language.
Service	Test run	<p>Select "Test run" from the Service menu to bring up the Test run menu.</p> <ul style="list-style-type: none"> • Test run • Drain pump test run
	Input maintenance	<p>Select "Input maintenance Info." from the Service menu to bring up the Maintenance information screen. The following settings can be made from the Maintenance Information screen.</p> <ul style="list-style-type: none"> • Model name input • Serial No. input • Dealer information input
	Function setting	Make the settings for the indoor unit functions via the remote controller as necessary.
	LOSSNAY setting (City Multi only)	This setting is required only when the operation of City Multi units is interlocked with LOSSNAY units.
	Check	<p>Error history: Display the error history and execute "delete error history".</p> <p>Refrigerant leak check (**): Refrigerant leaks can be judged.</p> <p>Smooth maintenance (**): The indoor and outdoor maintenance data can be displayed.</p> <p>Request code (**): Details of the operation data including each thermistor temperature and error history can be checked.</p>
	Self check	Error history of each unit can be checked via the remote controller.
Maintenance password	Use to change the maintenance password.	
Remote controller check	When the remote controller does not work properly, use the remote controller checking function to troubleshoot the problem.	

* Clock setting is required.

** This function cannot be set depending on the connected outdoor unit.

4

SPECIFICATIONS

Indoor unit service ref.		SLZ-M15FA.TH SLZ-M15FA.TH-ER	SLZ-M25FA.TH SLZ-M25FA.TH-ER	SLZ-M35FA.TH SLZ-M35FA.TH-ER	SLZ-M50FA.TH SLZ-M50FA.TH-ER	SLZ-M60FA.TH SLZ-M60FA.TH-ER					
Mode		Cooling Heating	Cooling Heating	Cooling Heating	Cooling Heating	Cooling Heating					
Power supply (phase, cycle, voltage)		Single phase 50 Hz, 230 V									
Electrical data	Input [kW]	0.02	0.02	0.02	0.02	0.03	0.03	0.04	0.04		
	Current* [A]	0.17	0.14	0.20	0.15	0.24	0.19	0.32	0.27	0.43	0.38
	Fan motor output* [kW]	0.05		0.05		0.05		0.05		0.05	
Air flow rate (Low/Medium/High) [m³/min]		7.0/6.5/6.0		6.5/7.5/8.5		6.5/8.0/9.5		7.0/9.0/11.5		7.5/11.5/13.0	
Noise level (Low/Medium/High) [dB]		28/26/24		25/28/31		25/30/34		27/34/39		32/40/43	
Dimensions	Width mm	UNIT: 570 PANEL: 625									
	Depth mm	UNIT: 570 PANEL: 625									
	Height mm	UNIT: 245 PANEL: 10									
Weight kg		UNIT: 15 PANEL: 3									

NOTE : Test conditions are based on ISO 5151.
 Cooling : Indoor D.B. 27°C W.B. 19°C
 Outdoor D.B. 35°C W.B. 24°C
 Heating : Indoor D.B. 20°C W.B. 15°C
 Outdoor D.B. 7°C W.B. 6°C
 Refrigerant piping length (one way): 7.5 m
 *Measured under rated operating frequency

Specifications and rating conditions of main electric parts

INDOOR UNIT

Service ref.	SLZ-M15/25/35/50/60FA.TH SLZ-M15/25/35/50/60FA.TH-ER	
Item	(FUSE)	250V 6.3A
Vane motor (MV)	MSBPC20M32 (Green label), MSBPC20M33 (Blue label): 12 V 300 W	
Terminal block (TB)	TO OUTDOOR UNIT: 3P TO WIRED REMOTE CONTROLLER: 2P	

5

NOISE CRITERION CURVES

SLZ-M15FA.TH SLZ-M15FA.TH-ER

<50Hz>

NOTCH	SPL(dB)	LINE
High	28	○—○
Medium	26	△—△
Low	24	□—□

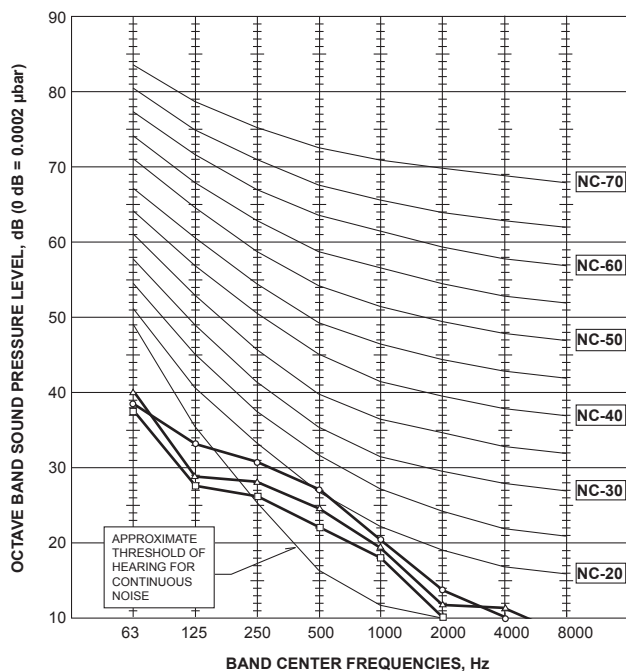

SLZ-M25FA.TH SLZ-M25FA.TH-ER

<50Hz>

NOTCH	SPL(dB)	LINE
High	31	○—○
Medium	28	△—△
Low	25	□—□

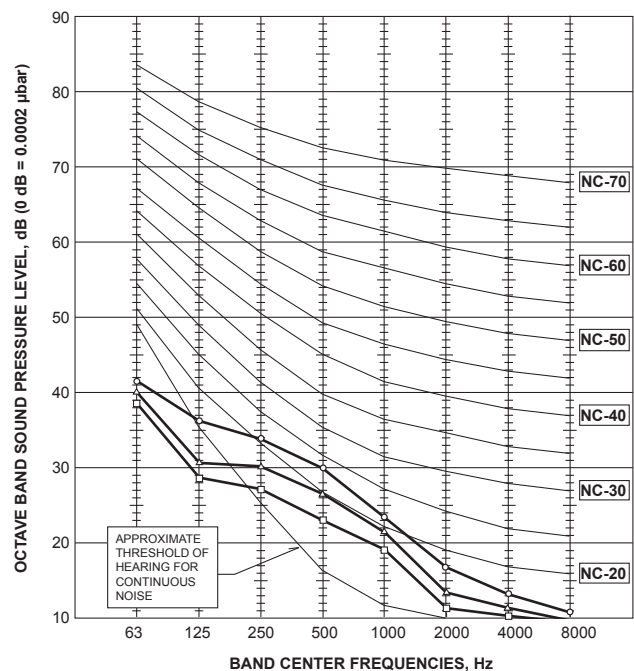

SLZ-M35FA.TH
SLZ-M35FA.TH-ER

<50Hz>

NOTCH	SPL(dB)	LINE
High	34	○—○
Medium	30	△—△
Low	25	□—□

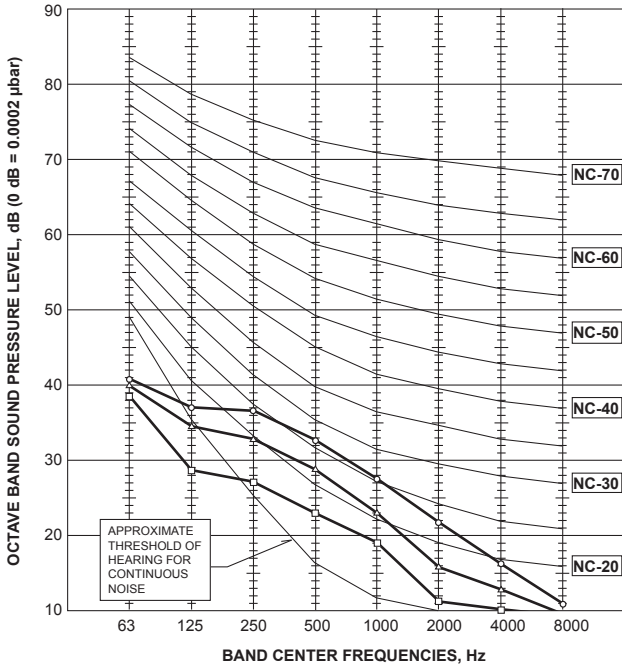

SLZ-M50FA.TH
SLZ-M50FA.TH-ER

<50Hz>

NOTCH	SPL(dB)	LINE
High	39	○—○
Medium	34	△—△
Low	27	□—□

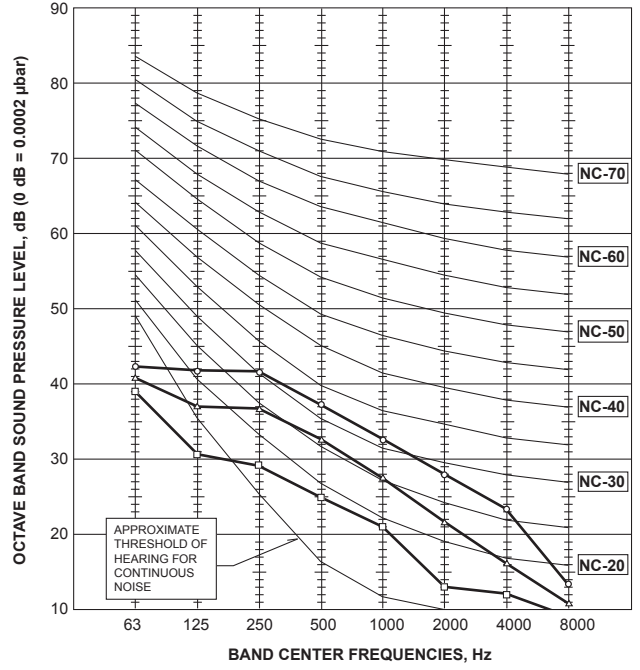

SLZ-M60FA.TH
SLZ-M60FA.TH-ER

<50Hz>

NOTCH	SPL(dB)	LINE
High	43	○—○
Medium	40	△—△
Low	32	□—□

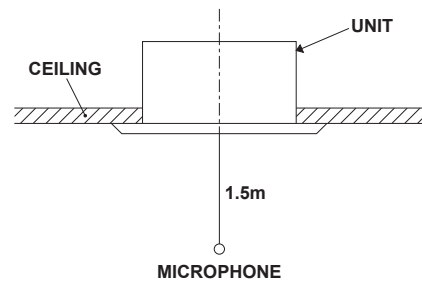
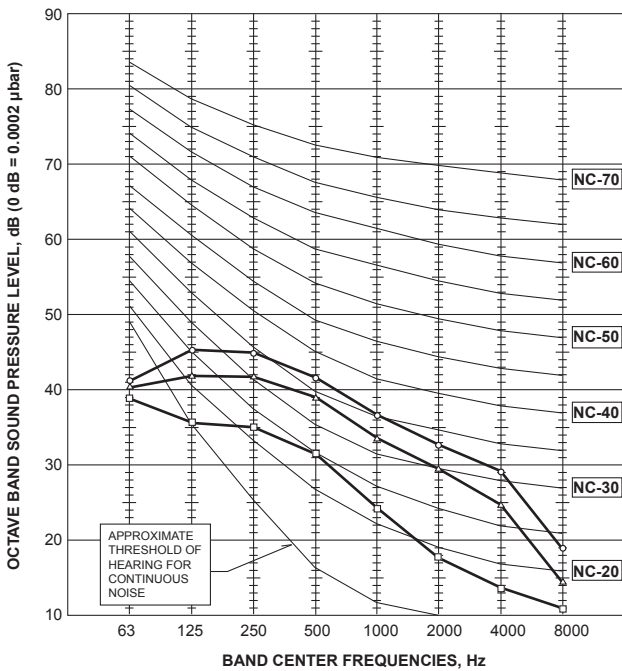

NOTE: The sound level is measured in an anechoic room where echoes are few, when compressor stops. The sound may be bigger than the indicated level in actual use due to surrounding echoes. The sound level can be higher by about 2 dB than the indicated level during cooling and heating operation.

SLZ-M15FA.TH
SLZ-M15FA.TH-ER

SLZ-M25FA.TH
SLZ-M25FA.TH-ER

SLZ-M35FA.TH
SLZ-M35FA.TH-ER

SLZ-M50FA.TH
SLZ-M50FA.TH-ER

SLZ-M60FA.TH
SLZ-M60FA.TH-ER

Unit: mm

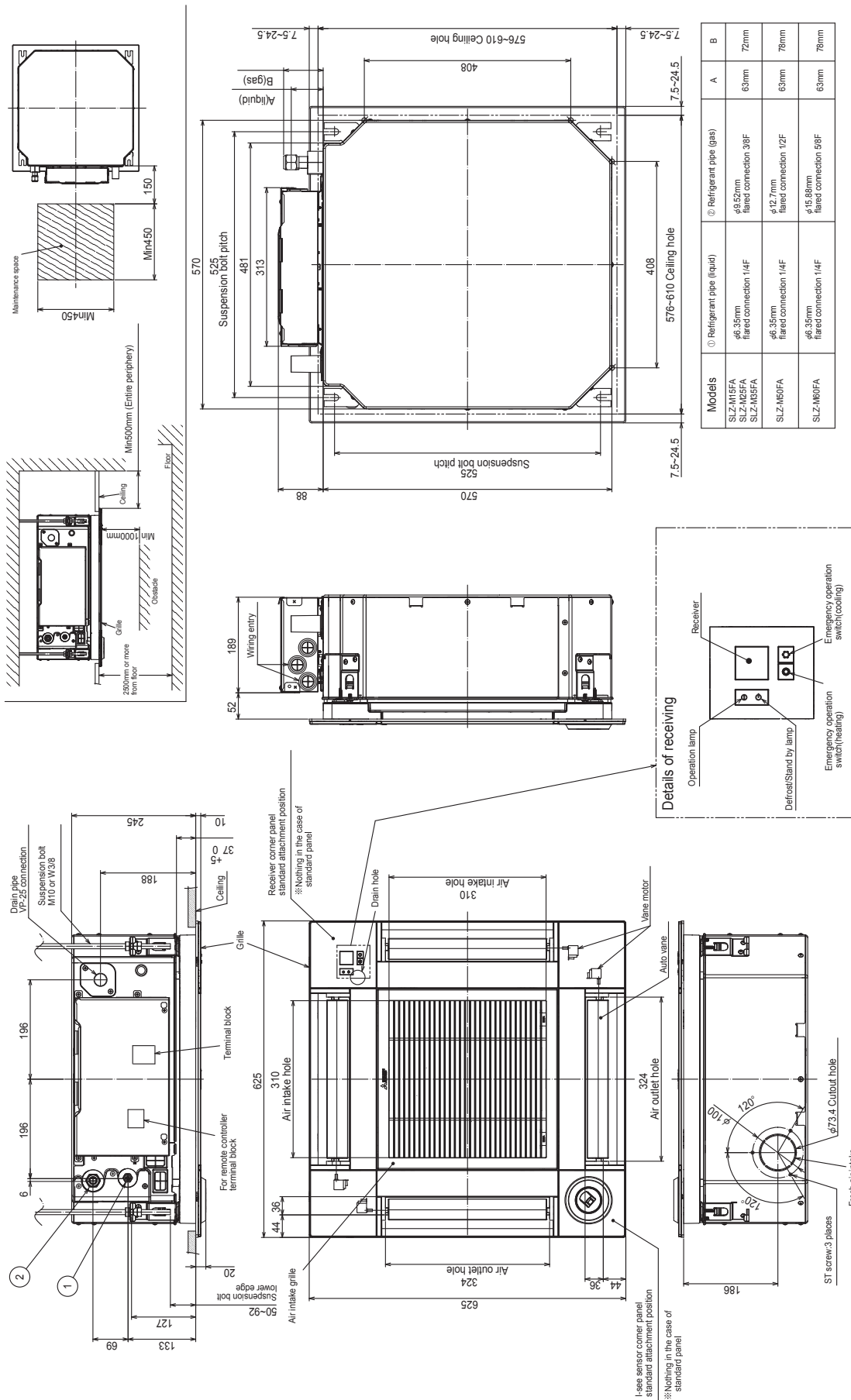

WIRELESS REMOTE CONTROLLER

PAR-SL100A-E

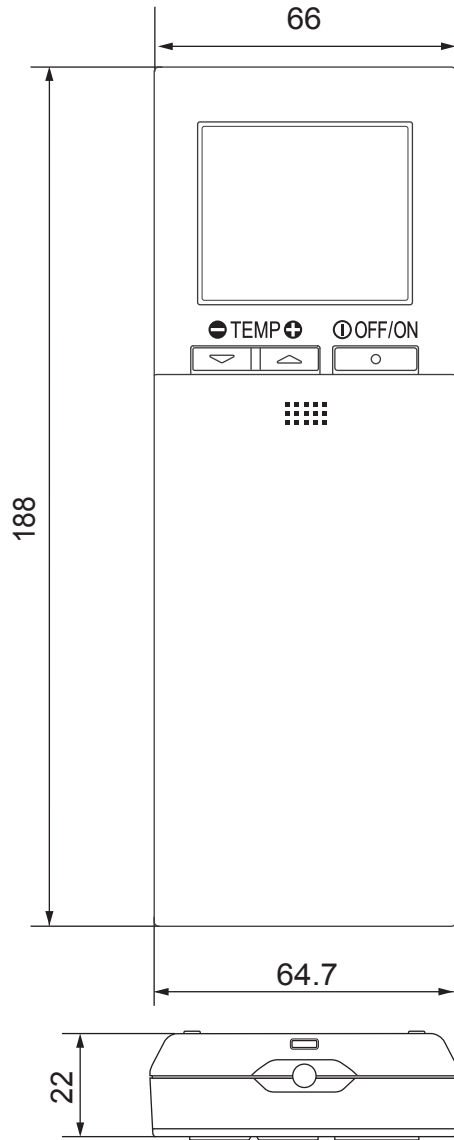

WIRED REMOTE CONTROLLER

PAR-33MAA

Unit: mm

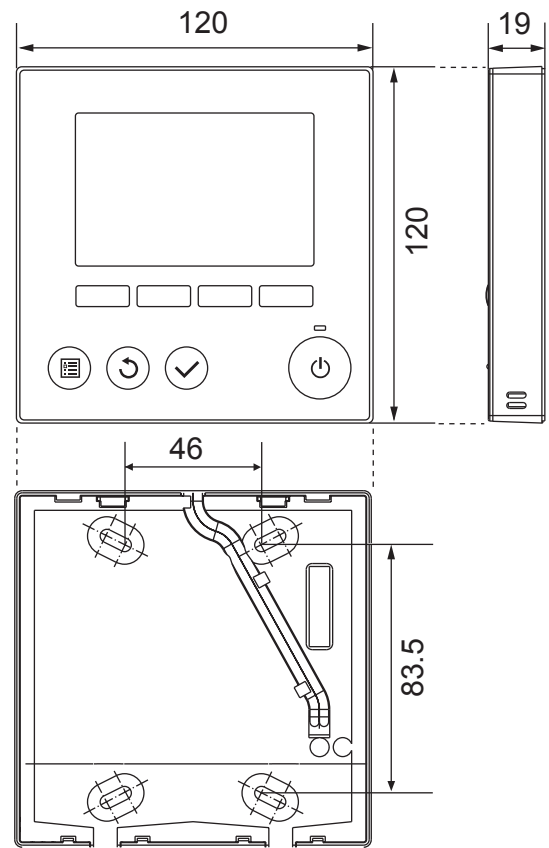

SLZ-M15FA.TH SLZ-M25FA.TH SLZ-M35FA.TH SLZ-M50FA.TH SLZ-M60FA.TH
 SLZ-M15FA.TH-ER SLZ-M25FA.TH-ER SLZ-M35FA.TH-ER SLZ-M50FA.TH-ER SLZ-M60FA.TH-ER

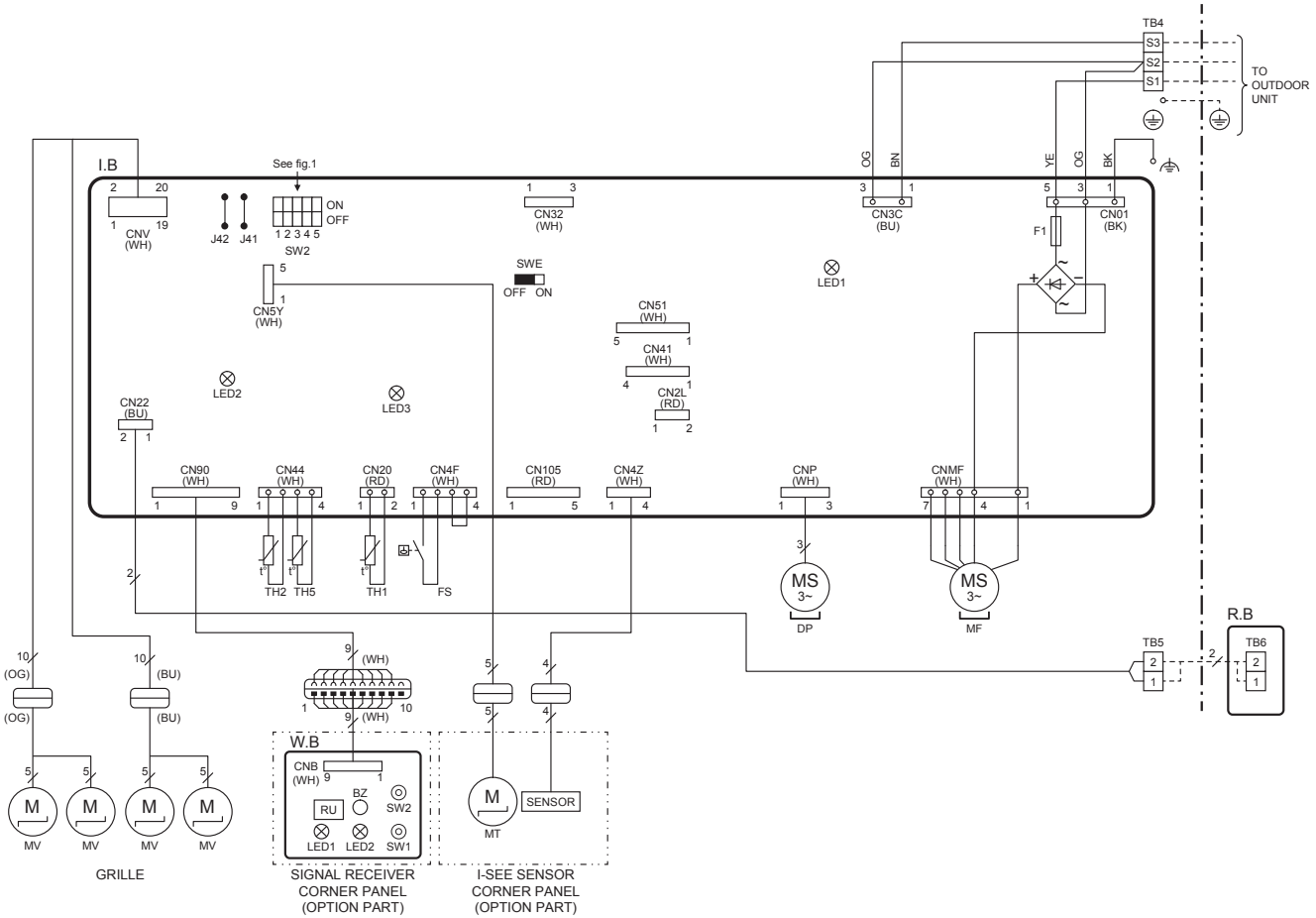

[LEGEND]

SYMBOL	NAME
I.B	INDOOR CONTROLLER BOARD
CN2L	CONNECTOR (LOSSNAY)
CN32	CONNECTOR (REMOTE SWITCH)
CN41	CONNECTOR (HA TERMINAL-A)
CN51	CONNECTOR (CENTRALLY CONTROL)
CN105	CONNECTOR (IT)
F1	FUSE (T6.3AL250V)
J41	JUMPER WIRE (PAIR NUMBER SETTING WITH WIRELESS REMOTE CONTROLLER)
J42	JUMPER WIRE (PAIR NUMBER SETTING WITH WIRELESS REMOTE CONTROLLER)
LED1	POWER SUPPLY (I.B)
LED2	POWER SUPPLY (WIRED REMOTE CONTROLLER)
LED3	COMMUNICATION (INDOOR-OUTDOOR)
SW2	DIP SWITCH (CAPACITY CODE)
SWE	JUMPER SWITCH (EMERGENCY OPERATION)
DP	DRAIN PUMP
FS	FLOAT SWITCH
MF	FAN MOTOR
MV	VANE MOTOR
TB4	TERMINAL BLOCK (INDOOR/OUTDOOR CONNECTING LINE)
TB5, TB6	TERMINAL BLOCK (REMOTE CONTROLLER TRANSMISSION LINE)
TH1	ROOM TEMP. THERMISTOR
TH2	PIPE TEMP. THERMISTOR (LIQUID)
TH5	CONDENSER / EVAPORATOR TEMP. THERMISTOR
OPTION PART	
W.B	WIRELESS REMOTE CONTROLLER BOARD
BZ	BUZZER
LED1	OPERATION (GREEN)
LED2	DEFROST/STAND BY (ORANGE)
RU	RECEIVING UNIT
SW1	EMERGENCY OPERATION (HEAT)
SW2	EMERGENCY OPERATION (COOL)
MT	I-SEE SENSOR MOTOR
R.B	WIRED REMOTE CONTROLLER

<fig.1>

MODELS	SW2	MODELS	SW2	MODELS	SW2
M15	ON OFF 1 2 3 4 5	M35	ON OFF 1 2 3 4 5	M60	ON OFF 1 2 3 4 5
M25	ON OFF 1 2 3 4 5	M50	ON OFF 1 2 3 4 5		

The black square (■) indicates a switch position.

- NOTES:
- Since the outdoor side electric wiring may change be sure to check the outdoor unit electric wiring for servicing.
 - Indoor and outdoor connecting wires are made with polarities, make wiring matching terminal numbers (S1, S2, S3).
 - Symbols used in wiring diagram are,
 : Connector, : Terminal (block)
 - For details on how to operate self-diagnosis refer to the technical manuals etc.

8

REFRIGERANT SYSTEM DIAGRAM

SLZ-M15FA.TH SLZ-M25FA.TH SLZ-M35FA.TH SLZ-M50FA.TH SLZ-M60FA.TH
 SLZ-M15FA.TH-ER SLZ-M25FA.TH-ER SLZ-M35FA.TH-ER SLZ-M50FA.TH-ER SLZ-M60FA.TH-ER

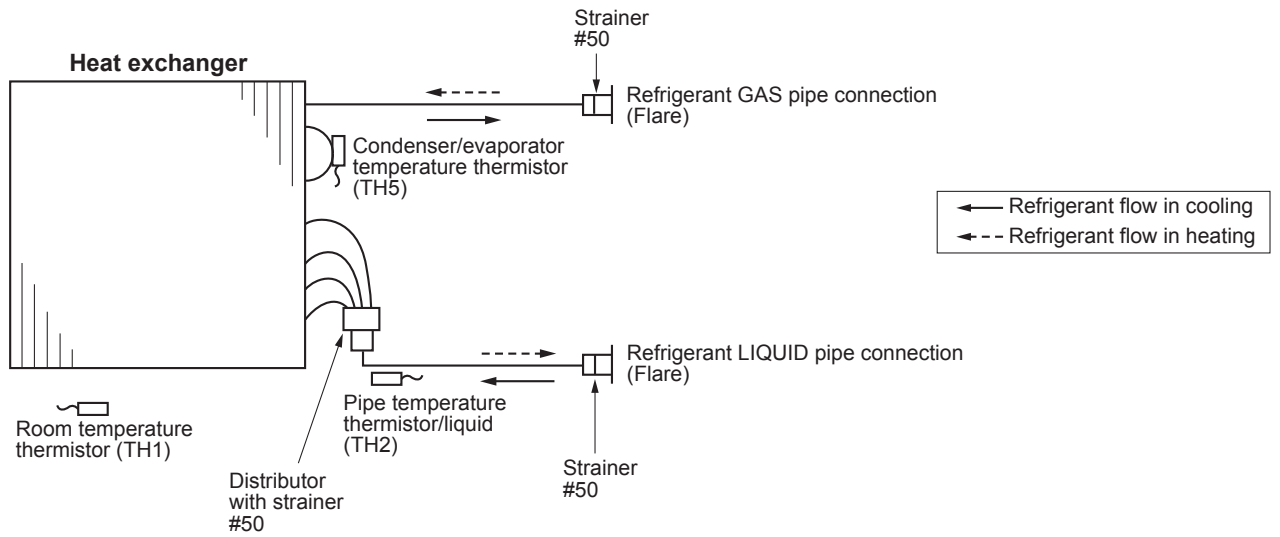

9-1. TROUBLESHOOTING

<Check code displayed by self-diagnosis and actions to be taken for service (summary)>

Present and past check codes are logged, and they can be displayed on the wired remote controller or controller board of outdoor unit. Actions to be taken for service, which depends on whether or not the trouble is reoccurring in the field, are summarized in the table below. Check the contents below before investigating details.

Unit conditions at service	Check code	Actions to be taken for service (summary)
The trouble is reoccurring.	Displayed	Judge what is wrong and take a corrective action according to "9-3. SELF-DIAGNOSIS ACTION TABLE".
	Not displayed	Conduct troubleshooting and ascertain the cause of the trouble according to "9-4. TROUBLESHOOTING OF PROBLEMS".
The trouble is not reoccurring.	Logged	① Consider the temporary defects such as the work of protection devices in the refrigerant circuit including compressor, poor connection of wiring, noise, etc. Re-check the symptom, and check the installation environment, refrigerant amount, weather when the trouble occurred, matters related to wiring, etc. ② Reset check code logs and restart the unit after finishing service. ③ There is no abnormality in electrical component, controller board, remote controller, etc.
	Not logged	① Re-check the abnormal symptom. ② Conduct troubleshooting and ascertain the cause of the trouble according to "9-4. TROUBLESHOOTING OF PROBLEMS". ③ Continue to operate unit for the time being if the cause is not ascertained. ④ There is no abnormality concerning of parts such as electrical component, controller board, remote controller, etc.

9-2. MALFUNCTION-DIAGNOSIS METHOD BY REMOTE CONTROLLER

<In case of trouble during operation>

When a malfunction occurs to air conditioner, both indoor unit and outdoor unit will stop and operation lamp blinks to inform unusual stop.

<Self-check>

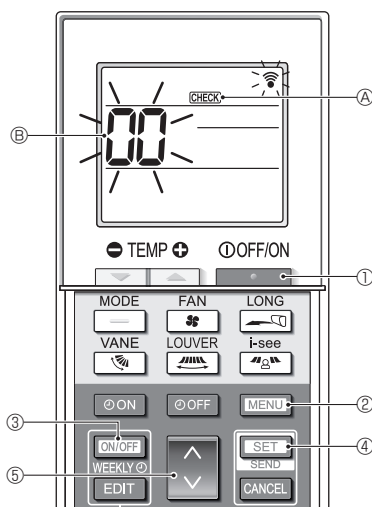

- Press the **①** button to stop the air conditioner.
 - If the weekly timer is enabled (**WEEKLY** is on), press the **ON/OFF WEEKLY** button **③** to disable it (**WEEKLY** is off).
- Press the **MENU** button **②** for 5 seconds.
 - CHECK** **A** comes on and the unit enters the self-check mode.
- Press the **↓** button **⑤** to select the refrigerant address (M-NET address) **B** of the indoor unit for which you want to perform the self-check.
- Press the **SET** button **④**.
 - If an error is detected, the check code is indicated by the number of beeps from the indoor unit and the number of blinks of the OPERATION INDICATOR lamp.
- Press the **①** button.
 - CHECK** **A** and the refrigerant address (M-NET address) **B** go off and the self-check is completed.

Refer to the following tables for details on the check codes.

[Output pattern A]

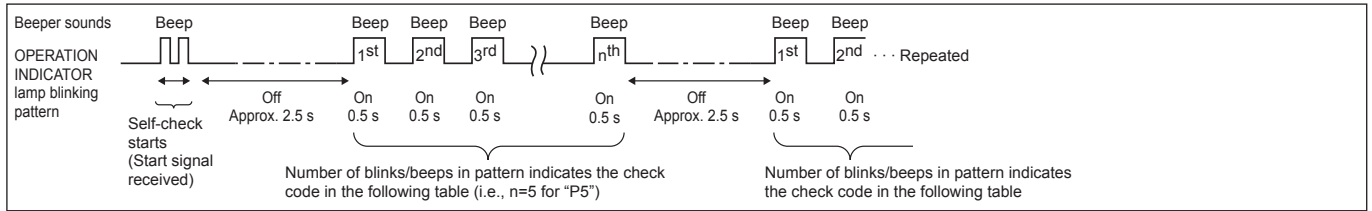

[Output pattern B]

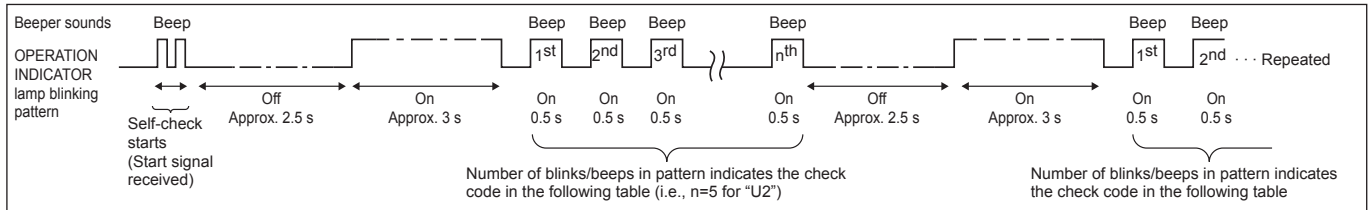

[Output pattern A] Errors detected by indoor unit

Wireless remote controller	Wired remote controller	Symptom	Remark
Beeper sounds/OPERATION INDICATOR lamp blinks (Number of times)	Check code		
1	P1	Intake sensor error	
2	P2, P9	Pipe (liquid or 2-phase pipe) sensor error	
3	E6, E7	Indoor/outdoor unit communication error	
4	P4	Float switch connector open	
5	P5	Drain pump error	
	PA	Forced compressor error	
6	P6	Freezing (during cooling operation)/Overheating protection operation (during heating operation)	
7	EE	Assembly error (system error)	
8	P8	Pipe temperature error	
9	E4	Communication error between wired remote controller and indoor unit	
10	—	—	
11	PB(Pb)	Indoor unit fan motor error	
12	FB(Fb)	Indoor unit control system error (memory error, etc.)	
14	PL	Refrigerant circuit abnormal	

[Output pattern B] Errors detected by unit other than indoor unit (outdoor unit, etc.)

Note: The supported check codes may vary depending on the connected outdoor unit.

Wireless remote controller	Wired remote controller	Symptom	Remark
Beeper sounds/OPERATION INDICATOR lamp blinks (Number of times)	Check code		
1	E9	Indoor/outdoor unit communication error	For details, check the LED display of the outdoor controller board.
2	UP	Compressor overcurrent interruption	
3	U3, U4	Open/short of outdoor unit thermistors	
4	UF	Compressor overcurrent interruption (When compressor locked)	
5	U2	Abnormal high discharging temperature/49C worked/insufficient refrigerant	
6	U1, Ud	Abnormal high pressure (63H worked)/Overheating protection operation	
7	U5	Abnormal temperature of heat sink	
8	U8	Outdoor unit fan protection stop	
9	U6	Compressor overcurrent interruption/Abnormal of power module	
10	U7	Abnormality of super heat due to low discharge temperature	
11	U9, UH	Abnormality such as overvoltage or voltage shortage and abnormal synchronous signal to main circuit/Current sensor error	
12	—	—	
13	—	—	
14	Others	Other errors (Refer to the technical manual for the outdoor unit.)	

Notes:

- If the beeper does not sound again after the initial 2 beeps to confirm the self-check start signal was received and the OPERATION INDICATOR lamp does not come on, there are no error records.
 - If the beeper sounds 3 times continuously "beep, beep, beep (0.4 + 0.4 + 0.4 seconds)" after the initial 2 beeps to confirm the self-check start signal was received, the specified refrigerant address is incorrect.
- On wireless remote controller
The continuous buzzer sounds from receiving section of indoor unit.
Blink of operation lamp
 - On wired remote controller
Check code displayed in the LCD.

Continued to the next page

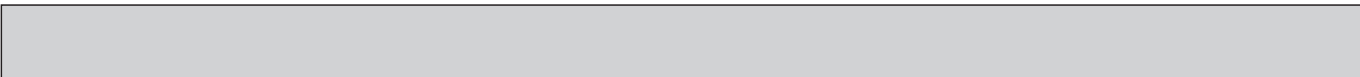

• If the unit cannot be operated properly after the test run, refer to the following table to find out the cause.

Symptom		Cause
Wired remote controller		
PLEASE WAIT	For about 2 minutes after power-on	• For about 2 minutes after power-on, operation of the remote controller is not possible due to system startup. (Correct operation)
PLEASE WAIT → check code	Subsequent to about 2 minutes after power-on	• Connector for the outdoor unit's protection device is not connected. • Reverse or open phase wiring for the outdoor unit's power terminal block
No messages appear even when operation switch is turned ON (operation lamp does not light up).		• Incorrect wiring between indoor and outdoor units. (incorrect polarity of S1, S2, S3) • Remote controller wire short

On the wireless remote controller with condition above, following phenomena take place.

- No signals from the remote controller can be received.
- Operation lamp is blinking.
- The buzzer makes a short ping sound.

Note:

Operation is not possible for about 30 seconds after cancellation of function selection. (Correct operation)

For description of each LED (LED1, 2, 3) provided on the indoor controller, refer to the following table.

LED1 (power for microprocessor)	Indicates whether control power is supplied. Make sure that this LED is always lit.
LED2 (power for remote controller)	Indicates whether power is supplied to the remote controller. This LED lights only in the case of the indoor unit which is connected to the outdoor unit refrigerant address "0".
LED3 (communication between indoor and outdoor units)	Indicates state of communication between the indoor and outdoor units. Make sure that this LED is always blinking.

Note: Errors to be detected in outdoor unit, such as codes starting with F, U or E (excluding E0 to E7), are not covered in this document. Please refer to the outdoor unit's service manual for the details.

9-3. SELF-DIAGNOSIS ACTION TABLE

Check code	Abnormal point and detection method	Cause	Countermeasure
P1	<p>Room temperature thermistor (TH1)</p> <p>① The unit is in 3-minute resume prevention mode if short/open of thermistor is detected. Abnormal if the unit does not reset normally after 3 minutes. (The unit returns to normal operation, if it has been reset normally.)</p> <p>② Constantly detected during cooling, drying and heating operation Short: -90°C or more Open: -40°C or less</p>	<p>① Defective thermistor characteristics</p> <p>② Contact failure of connector (CN20) on the indoor controller board (Insert failure)</p> <p>③ Breaking of wire or contact failure of thermistor wiring</p> <p>④ Defective indoor controller board</p>	<p>①-③ Check resistance value of thermistor. 0°C.....15.0 kΩ 10°C.....9.6 kΩ 20°C.....6.3 kΩ 30°C.....4.3 kΩ 40°C.....3.0 kΩ</p> <p>If you put force on (draw or bend) the lead wire with measuring resistance value of thermistor, breaking of wire or contact failure can be detected.</p> <p>② Check contact failure of connector (CN20) on the indoor controller board. Refer to "9-5. TEST POINT DIAGRAM". Turn the power back on and check restart after inserting connector again.</p> <p>④ Check room temperature display on remote controller Replace indoor controller board if there is abnormal difference with actual room temperature. Turn the power off, and on again to operate after checking.</p>
P2	<p>Pipe temperature thermistor/Liquid (TH2)</p> <p>① The unit is in 3-minute resume prevention mode if short/open of thermistor is detected. Abnormal if the unit does not reset normally after 3 minutes. (The unit returns to normal operation, if it has been reset normally.)</p> <p>② Constantly detected during cooling, drying, and heating (except defrosting) operation. Short: 90°C or more Open: -40°C or less</p>	<p>① Defective thermistor characteristics</p> <p>② Contact failure of connector (CN44) on the indoor controller board (Insert failure)</p> <p>③ Breaking of wire or contact failure of thermistor wiring</p> <p>④ Defective refrigerant circuit is causing thermistor temperature of 90°C or more or -40°C or less.</p> <p>⑤ Defective indoor controller board</p>	<p>①-③ Check resistance value of thermistor. For characteristics, refer to (P1) above.</p> <p>② Check contact failure of connector (CN44) on the indoor controller board. Refer to "9-5. TEST POINT DIAGRAM". Turn the power on and check restart after inserting connector again. Check pipe <liquid> temperature with remote controller in test run mode. If pipe <liquid> temperature is extremely low (in cooling mode) or high (in heating mode), refrigerant</p> <p>④ circuit may have defect.</p> <p>⑤ Check pipe <liquid> temperature with remote controller in test run mode. If there is extreme difference with actual pipe <liquid> temperature, replace indoor controller board. Turn the power off, and on again to operate after checking.</p>
P4	<p>Contact failure of drain float switch (CN4F)</p> <ul style="list-style-type: none"> • Extract when the connector of drain float switch is disconnected. (③ and ④ of connector CN4F is not short-circuited.) • Constantly detected during operation 	<p>① Contact failure of connector (Insert failure)</p> <p>② Defective indoor controller board</p>	<p>① Check contact failure of float switch connector. Turn the power on again and check after inserting connector again.</p> <p>② Operate with connector (CN4F) short-circuited. Replace indoor controller board if abnormality reappears.</p>
P5	<p>Malfunction of drain pump (DP)</p> <p>① Suspensive abnormality, if thermistor of drain sensor heats itself and temperature rises slightly. Turn off compressor and indoor fan.</p> <p>② Drain pump is abnormal if the condition above is detected during suspensive abnormality.</p> <p>③ Constantly detected during drain pump operation</p>	<p>① Malfunction of drain pump</p> <p>② Defective drain Clogged drain pump Clogged drain pipe</p> <p>③ Defective drain float switch Jamming of the drain float switch or malfunction of moving parts causing the drain float switch to be detected under water (Switch On)</p> <p>④ Defective indoor controller board</p>	<p>① Check if drain pump works.</p> <p>② Check drain function.</p> <p>③ Remove drain float switch connector CN4F and check if it is short (Switch On) with the moving part of float switch UP, or OPEN with the moving part of float switch down. Replace float switch if it is short with the moving part of float switch down.</p> <p>④ Replace indoor controller board if it is short-circuited between ③-④ of the drain float switch connector CN4F and abnormality reappears.</p> <p>It is not abnormal if there is no problem about the above-mentioned ①-④. Turn the power off, and on again to operate after check.</p>
	<p>Drain pump lock protection operation</p> <p>① Suspensive abnormality, if drain pump stops for 5 seconds continuously with drain pump on. Drain pump will be restarted after turning off for 10 seconds.</p> <p>② Drain pump is abnormal if the condition above is detected 4 times during suspensive abnormality.</p>	<p>① Malfunction of drain pump</p> <p>② Clogged drain pump</p> <p>③ Disconnected drain pump</p> <p>④ Defective indoor controller board</p>	<p>①② Check if drain pump works.</p> <p>③ Check if connector (CNP) is connected.</p> <p>④ Turn the emergency operation switch (SWE) on and check the voltage between CNP ①-③.</p> <ul style="list-style-type: none"> • Replace drain pump if the output is 13V DC. • Replace indoor controller board if the output is under 13V DC.

Check code	Abnormal point and detection method	Cause	Countermeasure
P6	<p>Freezing/overheating protection is operating</p> <p>① Freezing protection (Cooling mode) The unit is in 6-minute resume prevention mode if pipe <liquid or condenser/evaporator> temperature stays under -15°C for 3 minutes after the compressor started. Abnormal if it stays under -15°C for 3 minutes again within 16 minutes after 6-minute resume prevention mode.</p> <p>② Overheating protection (Heating mode) The units is in 6-minute resume prevention mode if pipe <condenser/evaporator> temperature is detected as over 70°C after the compressor started. Abnormal if the temperature of over 70°C is detected again within 10 minutes after 6-minute resume prevention mode.</p>	<p>(Cooling or drying mode)</p> <p>① Clogged filter (reduced airflow) ② Short cycle of air path ③ Low-load (low temperature) operation out of the tolerance range ④ Defective indoor fan motor • Fan motor is defective. • Indoor controller board is defective.</p> <p>⑤ Defective outdoor fan control ⑥ Overcharge of refrigerant ⑦ Defective refrigerant circuit (clogging)</p> <p>(Heating mode)</p> <p>① Clogged filter (reduced airflow) ② Short cycle of air path ③ Overload (high temperature) operation out of the tolerance range ④ Defective indoor fan motor • Fan motor is defective. • Indoor controller board is defective. ⑤ Defective outdoor fan control ⑥ Overcharge of refrigerant ⑦ Defective refrigerant circuit (clogging) ⑧ Bypass circuit of outdoor unit is defective.</p>	<p>(Cooling or drying mode)</p> <p>① Check clogging of the filter. ② Remove blockage.</p> <p>④ Refer to "9-7-2. DC Fan Motor (Fan Motor / Indoor Controller Board)".</p> <p>⑤ Check outdoor fan motor.</p> <p>⑥⑦ Check operating condition of refrigerant circuit.</p> <p>(Heating mode)</p> <p>① Check clogs of the filter. ② Remove blockage.</p> <p>④ Refer to "9-7-2. DC Fan Motor (Fan Motor / Indoor Controller Board)".</p> <p>⑤ Check outdoor fan motor. ⑥-⑧ Check operating condition of refrigerant circuit.</p>
P8	<p>Pipe temperature</p> <p><Cooling mode> Detected as abnormal when the pipe temperature is not in the cooling range 3 minutes after compressor start and 6 minutes after the liquid or condenser/evaporator pipe is out of cooling range. Note 1: It takes at least 9 minutes to detect. Note 2: Abnormality P8 is not detected in drying mode. Cooling range: $-3^{\circ}\text{C} \geq (\text{TH}-\text{TH1})$ TH: Lower temperature between liquid pipe temperature (TH2) and condenser/evaporator temperature (TH5) TH1: Intake temperature</p> <p><Heating mode> When 10 seconds have passed after the compressor starts operation and the hot adjustment mode has finished, the unit is detected as abnormal when condenser/evaporator pipe temperature is not in heating range within 20 minutes. Note 3: It takes at least 27 minutes to detect abnormality. Note 4: It excludes the period of defrosting (Detection restarts when defrosting mode is over) Heating range: $3^{\circ}\text{C} \leq (\text{TH5}-\text{TH1})$</p>	<p>① Slight temperature difference between indoor room temperature and pipe <liquid or condenser/evaporator> temperature thermistor • Shortage of refrigerant • Disconnected holder of pipe <liquid or condenser/evaporator> thermistor • Defective refrigerant circuit</p> <p>② Converse connection of extension pipe (on plural units connection)</p> <p>③ Converse wiring of indoor/outdoor unit connecting wire (on plural units connection)</p> <p>④ Defective detection of indoor room temperature and pipe <condenser/evaporator> temperature thermistor</p> <p>⑤ Stop valve is not opened completely.</p>	<p>①-④ Check pipe <liquid or condenser/evaporator> temperature with room temperature display on remote controller and outdoor controller circuit board. Pipe <liquid or condenser/evaporator> temperature display is indicated by setting SW2 of outdoor controller circuit board as follows.</p> <p>(Conduct temperature check with outdoor controller circuit board after connecting 'A-Control Service Tool (PAC-SK52ST)').</p> <p>②③ Check converse connection of extension pipe or converse wiring of indoor/outdoor unit connecting wire.</p>



Check code	Abnormal point and detection method	Cause	Countermeasure
P9	<p>Pipe temperature thermistor/Condenser/Evaporator (TH5)</p> <p>① The unit is in 3-minute resume protection mode if short/open of thermistor is detected. Abnormal if the unit does not get back to normal within 3 minutes. (The unit returns to normal operation, if it has been reset normally.)</p> <p>② Constantly detected during cooling, drying, and heating operation (except defrosting) Short: 90°C or more Open: -40°C or less</p>	<p>① Defective thermistor characteristics</p> <p>② Contact failure of connector (CN44) on the indoor controller board (Insert failure)</p> <p>③ Breaking of wire or contact failure of thermistor wiring</p> <p>④ Temperature of thermistor is 90°C or more or -40°C or less caused by defective refrigerant circuit.</p> <p>⑤ Defective indoor controller board</p>	<p>①-③ Check resistance value of thermistor. For characteristics, refer to (P1).</p> <p>② Check contact failure of connector (CN44) on the indoor controller board. Refer "9-5. TEST POINT DIAGRAM". Turn the power on and check restart after inserting connector again.</p> <p>④ Operate in test run mode and check pipe <condenser/evaporator> temperature with outdoor controller circuit board. If pipe <condenser/evaporator> temperature is extremely low (in cooling mode) or high (in heating mode), refrigerant circuit may have defect.</p> <p>⑤ Operate in test run mode and check pipe <condenser/evaporator> temperature with outdoor control circuit board. If there is extreme difference with actual pipe <condenser/evaporator> temperature replace indoor controller board. There is no abnormality if none of the above comes within the unit. Turn the power off and on again to operate.</p> <p style="text-align: center;">(In case of checking pipe temperature with outdoor controller circuit board, be sure to connect A-control service tool (PAC-SK52ST).)</p>
PL	<p>Abnormal refrigerant circuit</p> <p>During Cooling, Dry, or Auto Cooling operation, the following conditions are regarded as failures when detected for 1 second.</p> <p>a)The compressor continues to run for 30 or more seconds.</p> <p>b)The liquid pipe temperature or the condenser/evaporator temperature is 75°C or more.</p> <p><u>These detected errors will not be cancelled until the power source is reset.</u></p>	<p>① Abnormal operation of 4-way valve</p> <p>② Disconnection of or leakage in refrigerant pipes</p> <p>③ Air into refrigerant piping</p> <p>④ Abnormal operation (no rotation) of indoor fan</p> <ul style="list-style-type: none"> · Defective fan motor · Defective indoor control board <p>⑤ Defective refrigerant circuit (clogging)</p>	<p>① <u>When this error occurs, be sure to replace the 4-way valve.</u></p> <p>② Check refrigerant pipes for disconnection or leakage.</p> <p>③ After the recovery of refrigerant, vacuum dry the whole refrigerant circuit.</p> <p>④ Refer to section "9-7. TROUBLE CRITERION OF MAIN PARTS".</p> <p>⑤ Check refrigerant circuit for operation. <u>To avoid entry of moisture or air into refrigerant circuit which could cause abnormal high pressure, purge air in refrigerant circuit or replace refrigerant.</u></p>
E0 or E4 (6831 or 6834)	<p>Remote controller transmission error(E0)/signal receiving error(E4)</p> <p>① Abnormal if main or sub remote controller cannot receive any transmission normally from indoor unit of refrigerant address "0" for 3 minutes. (Check code : E0)</p> <p>② Abnormal if sub-remote controller could not receive for any signal for 2 minutes. (Check code: E0)</p> <p>① Abnormal if indoor controller board cannot receive normally any data from remote controller board or from other indoor controller board for 3 minutes. (Check code: E4)</p> <p>② Indoor controller board cannot receive any signal from remote controller for 2 minutes. (Check code: E4)</p>	<p>① Contact failure at transmission wire of remote controller</p> <p>② All remote controllers are set as "sub" remote controller. In this case, E0 is displayed on remote controller, and E4 is displayed at LED (LED1, LED2) on the outdoor controller circuit board.</p> <p>③ Miswiring of remote controller</p> <p>④ Defective transmitting/receiving circuit of remote controller</p> <p>⑤ Defective transmitting/receiving circuit of indoor controller board of refrigerant address "0"</p> <p>⑥ Noise has entered into the transmission wire of remote controller.</p>	<p>① Check disconnection or looseness of indoor unit or transmission wire of remote controller.</p> <p>② Set one of the remote controllers "main", if there is no problem with the action above.</p> <p>③ Check wiring of remote controller.</p> <ul style="list-style-type: none"> • Total wiring length: max. 500 m (Do not use cable × 3 or more) • The number of connecting indoor units: max. 16 units • The number of connecting remote controller: max. 2 units <p>If the cause of trouble is not in above ①-③,</p> <p>④ Diagnose remote controllers.</p> <p>a) When "RC OK" is displayed, remote controllers have no problem. Turn the power off, and on again to check. If abnormality generates again, replace indoor controller board.</p> <p>b) When "RC NG" is displayed, replace remote controller.</p> <p>c) When "RC E3" or "ERC 00-66" is displayed, noise may be causing abnormality.</p>



Check code	Abnormal point and detection method	Cause	Countermeasure
E3 or E5 (6832 or 6833)	<p>Remote controller transmission error(E3)/signal receiving error(E5)</p> <p>① Abnormal if remote controller could not find blank of transmission path for 6 seconds and could not transmit. (Check code: E3)</p> <p>② Remote controller receives transmitted data at the same time, compares the data, and when detecting it, judges different data to be abnormal 30 continuous times. (Check code: E3)</p> <p>① Abnormal if indoor controller board could not find blank of transmission path. (Check code: E5)</p> <p>② Indoor controller board receives transmitted data at the same time, compares the data, and when detecting it, judges different data to be abnormal 30 continuous times. (Check code: E5)</p>	<p>① 2 remote controllers are set as "main." (In case of 2 remote controllers)</p> <p>② Remote controller is connected with 2 indoor units or more.</p> <p>③ Repetition of refrigerant address</p> <p>④ Defective transmitting/receiving circuit of remote controller</p> <p>⑤ Defective transmitting/receiving circuit of indoor controller board</p> <p>⑥ Noise has entered into transmission wire of remote controller.</p>	<p>① Set a remote controller to main, and the other to sub.</p> <p>② Remote controller is connected with only one indoor unit.</p> <p>③ The address changes to a separate setting.</p> <p>④-⑥ Diagnose remote controller.</p> <p>a) When "RC OK" is displayed, remote controllers have no problem. Turn the power off, and on again to check. When becoming abnormal again, replace indoor controller board.</p> <p>b) When "RC NG" is displayed, replace remote controller.</p> <p>c) When "RC E3" or "ERC 00-66" is displayed, noise may be causing abnormality.</p>
E6	<p>Indoor/outdoor unit communication error (Signal receiving error)</p> <p>① Abnormal if indoor controller board cannot receive any signal normally for 6 minutes after turning the power on.</p> <p>② Abnormal if indoor controller board cannot receive any signal normally for 3 minutes.</p> <p>③ Consider the unit abnormal under the following condition: When 2 or more indoor units are connected to one outdoor unit, indoor controller board cannot receive a signal for 3 minutes from outdoor controller circuit board, a signal which allows outdoor controller circuit board to transmit signals.</p>	<p>① Contact failure, short circuit or, miswiring (converse wiring) of indoor/outdoor unit connecting wire</p> <p>② Defective transmitting/receiving circuit of indoor controller board</p> <p>③ Defective transmitting/receiving circuit of indoor controller board</p> <p>④ Noise has entered into indoor/outdoor unit connecting wire.</p>	<p>① Check disconnection or looseness of indoor/outdoor unit connecting wire of indoor unit or outdoor unit. Check all the units in case of twin indoor unit system.</p> <p>②-④ Turn the power off, and on again to check. If abnormality generates again, replace indoor controller board or outdoor controller circuit board.</p> <p>Note: Other indoor controller board may have defect in case of twin indoor unit system.</p>
E7	<p>Indoor/outdoor unit communication error (Transmitting error)</p> <p>Abnormal if "1" receiving is detected 30 times continuously though indoor controller board has transmitted "0".</p>	<p>① Defective transmitting receiving circuit of indoor controller board</p> <p>② Noise has entered into power supply.</p> <p>③ Noise has entered into outdoor control wire.</p>	<p>①-③ Turn the power off, and on again to check. If abnormality generates again, replace indoor controller board.</p>
FB(Fb)	<p>Indoor controller board</p> <p>Abnormal if data cannot be normally read from the nonvolatile memory of the indoor controller board.</p>	<p>① Defective indoor controller board</p>	<p>① Replace indoor controller board.</p>
E1 or E2 (6201 or 6202)	<p>Remote controller control board</p> <p>① Abnormal if data cannot be normally read from the nonvolatile memory of the remote controller control board. (Check code: E1)</p> <p>② Abnormal if the clock function of remote controller cannot be normally operated. (Check code: E2)</p>	<p>① Defective remote controller</p>	<p>① Replace remote controller.</p>

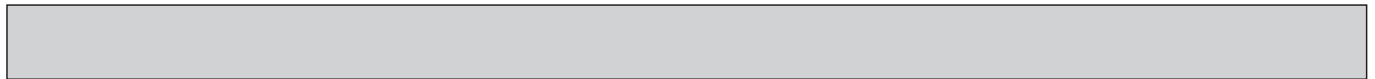

Check code	Abnormal point and detection method	Cause	Countermeasure
PA (2502) (2500)	<p>Forced compressor stop (due to water leakage abnormality)</p> <p>① When the intake temperature subtracted from liquid pipe temperature is less than -10°C, drain sensor detects whether it is soaked in the water or not at the interval of 90 seconds. (Drain pump will start operating when the drain sensor detects to be soaked in the water.)</p> <p>② The unit has a water leakage abnormality when the following conditions, a) and b), are satisfied while the above-mentioned detection is performed.</p> <p>a) The drain sensor detects to be soaked in the water 10 times in a row.</p> <p>b) The intake temperature subtracted from liquid pipe temperature is detected to be less than -10°C for a total of 30 minutes. (When the drain sensor detects to be NOT soaked in the water, the detection record of a) and b) will be cleared.)</p> <p>③ The drain sensor detection is performed in operations other than cooling. (When the unit stops operating, during heating or fan operation, when the unit stops because of some abnormalities) Note: Once the water leakage abnormality is detected, abnormality state will not be released until the main power is reset.</p>	<p>① Drain pump trouble</p> <p>② Drain defective · Drain pump clogging · Drain pipe clogging</p> <p>③ Open circuit of drain sensor side heater</p> <p>④ Contact failure of drain sensor connector</p> <p>⑤ Dew condensation on drain sensor · Drain water trickles along lead wire · Drain water waving due to filter clogging</p> <p>⑥ Extension piping connection difference at twin, triple, quadruple system</p> <p>⑦ Miswiring of indoor/outdoor connecting at twin, triple, quadruple system</p> <p>⑧ Room temperature thermistor/ liquid pipe temperature thermistor detection is defective.</p>	<p>① Check the drain pump.</p> <p>② Please check whether water can be drained.</p> <p>③ Check the resistance of the drain sensor side heater.</p> <p>④ Check the connector contact failure.</p> <p>⑤ Check the drain sensor lead wire mounted. Check the filter clogging.</p> <p>⑥ Check the piping connection.</p> <p>⑦ Check the indoor/outdoor connecting wires.</p> <p>⑧ Check the room temperature display of remote controller. Check the indoor liquid pipe temperature display of outdoor controller board.</p>
PB(Pb)	<p>Fan motor trouble</p>	<p>① Defective fan motor</p> <p>② Defective indoor controller board</p>	<p>①② Refer to "9-7-2. DC Fan Motor (Fan Motor/ Indoor Controller Board)".</p>

9-4. TROUBLESHOOTING OF PROBLEMS

Note: Refer to the manual of outdoor unit for the detail of remote controller.

Phenomena	Cause	Countermeasure
(1) LED2 on indoor controller board is off.	<ul style="list-style-type: none"> • When LED1 on indoor controller board is also off. ① Power supply of rated voltage is not supplied to outdoor unit. ② Defective outdoor controller circuit board ③ Power supply of 220–240 V AC is not supplied to indoor unit. ④ Defective indoor controller board 	<ul style="list-style-type: none"> ① Check the voltage of outdoor power supply terminal block (L, N) or (L₃, N). <ul style="list-style-type: none"> • When 220–240 V AC is not detected, check the power wiring to outdoor unit and the breaker. • When 220–240 V AC is detected, check ② (below). ② Check the voltage between outdoor terminal block S1 and S2. <ul style="list-style-type: none"> • When 220–240 V AC is not detected, —check the fuse on outdoor controller circuit board. —check the wiring connection. • When 220–240 V AC is detected, check ③ (below). ③ Check the voltage between indoor terminal block S1 and S2. <ul style="list-style-type: none"> • When 220–240 V AC is not detected, check indoor/outdoor unit connecting wire for miswiring. • When 220–240 V AC is detected, check ④ (below). ④ Check the wiring connection between TB4 and CN01. Check the fuse on indoor controller board. If no problems are found, indoor controller board is defective.
	<ul style="list-style-type: none"> • When LED1 on indoor controller board is lit. ① Mis-setting of refrigerant address for outdoor unit (There is no unit corresponding to refrigerant address “0”.) 	<ul style="list-style-type: none"> ① Check the setting of refrigerant address for outdoor unit. Set the refrigerant address to “0”. (For grouping control system under which 2 or more outdoor units are connected, set one of the units to “0”.) Set refrigerant address using SW1 (3-6) on outdoor controller circuit board.
(2) LED2 on indoor controller board is blinking.	<ul style="list-style-type: none"> • When LED1 on indoor controller board is also blinking. Connection failure of indoor/outdoor unit connecting wire • When LED1 is lit ① Miswiring of remote controller wires Under twin indoor unit system, 2 or more indoor units ② Refrigerant address for outdoor unit is wrong or not set. Under grouping control system, there are some units whose refrigerant address is 0. ③ Short-cut of remote controller wires ④ Defective remote controller 	<p>Check indoor/outdoor unit connecting wire for connection failure.</p> <ul style="list-style-type: none"> ① Check the connection of remote controller wires in case of twin triple indoor unit system. When 2 or more indoor units are wired in one refrigerant system, connect remote controller wires to one of those units. ② Check the setting of refrigerant address in case of grouping control system. If there are some units whose refrigerant addresses are 0 in one group, set one of the units to 0 using SW1 (3-6) on outdoor controller circuit board. ③④ Remove remote controller wires and check LED2 on indoor controller board. <ul style="list-style-type: none"> • When LED2 is blinking, check the short-cut of remote controller wires. • When LED2 is lit, connect remote controller wires again and: if LED2 is blinking, remote controller is defective; if LED2 is lit, connection failure of remote controller terminal block, etc. has returned to normal.

9-5. TEST POINT DIAGRAM

9-5-1. Indoor controller board

SLZ-M15FA.TH SLZ-M25FA.TH SLZ-M35FA.TH SLZ-M50FA.TH SLZ-M60FA.TH
 SLZ-M15FA.TH-ER SLZ-M25FA.TH-ER SLZ-M35FA.TH-ER SLZ-M50FA.TH-ER SLZ-M60FA.TH-ER

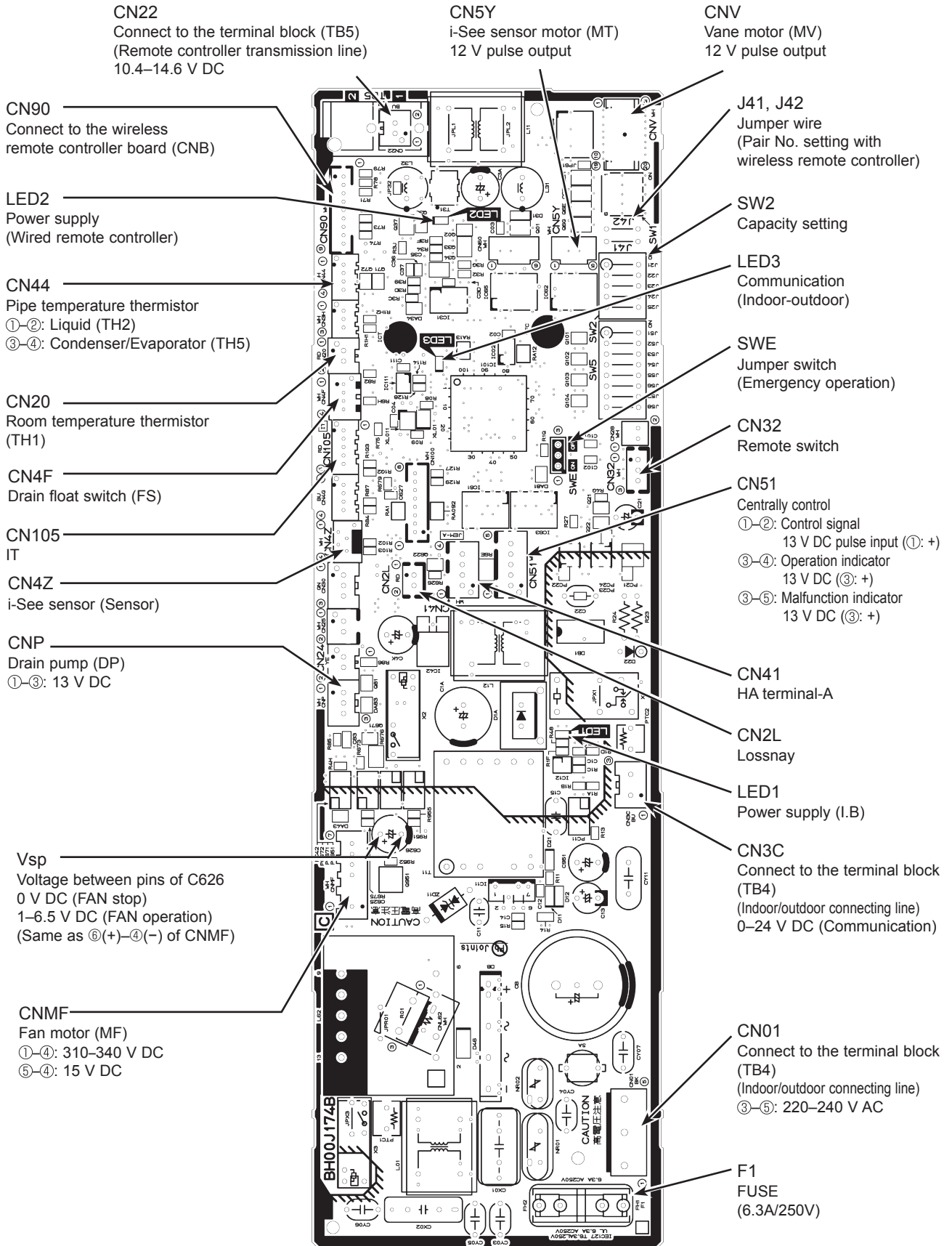

9-6. FUNCTION OF DIP SWITCH

Each function is controlled by the DIP switch and the jumper wire on the indoor controller board.

The black square (■) indicates a switch position.

Switch	Functions	Setting by the DIP switch	Remarks																																																																								
SW2	Capacity setting	<table border="1"> <thead> <tr> <th>Model</th> <th>Setting</th> </tr> </thead> <tbody> <tr> <td>SLZ-M15FA</td> <td> <table border="1"> <tr> <td>1</td><td>2</td><td>3</td><td>4</td><td>5</td> <td>ON OFF</td> </tr> <tr> <td>■</td><td>■</td><td>■</td><td>■</td><td>■</td> <td></td> </tr> </table> </td> </tr> <tr> <td>SLZ-M25FA</td> <td> <table border="1"> <tr> <td>1</td><td>2</td><td>3</td><td>4</td><td>5</td> <td>ON OFF</td> </tr> <tr> <td>■</td><td>■</td><td>■</td><td>■</td><td>■</td> <td></td> </tr> </table> </td> </tr> <tr> <td>SLZ-M35FA</td> <td> <table border="1"> <tr> <td>1</td><td>2</td><td>3</td><td>4</td><td>5</td> <td>ON OFF</td> </tr> <tr> <td>■</td><td>■</td><td>■</td><td>■</td><td>■</td> <td></td> </tr> </table> </td> </tr> <tr> <td>SLZ-M50FA</td> <td> <table border="1"> <tr> <td>1</td><td>2</td><td>3</td><td>4</td><td>5</td> <td>ON OFF</td> </tr> <tr> <td>■</td><td>■</td><td>■</td><td>■</td><td>■</td> <td></td> </tr> </table> </td> </tr> <tr> <td>SLZ-M60FA</td> <td> <table border="1"> <tr> <td>1</td><td>2</td><td>3</td><td>4</td><td>5</td> <td>ON OFF</td> </tr> <tr> <td>■</td><td>■</td><td>■</td><td>■</td><td>■</td> <td></td> </tr> </table> </td> </tr> </tbody> </table>	Model	Setting	SLZ-M15FA	<table border="1"> <tr> <td>1</td><td>2</td><td>3</td><td>4</td><td>5</td> <td>ON OFF</td> </tr> <tr> <td>■</td><td>■</td><td>■</td><td>■</td><td>■</td> <td></td> </tr> </table>	1	2	3	4	5	ON OFF	■	■	■	■	■		SLZ-M25FA	<table border="1"> <tr> <td>1</td><td>2</td><td>3</td><td>4</td><td>5</td> <td>ON OFF</td> </tr> <tr> <td>■</td><td>■</td><td>■</td><td>■</td><td>■</td> <td></td> </tr> </table>	1	2	3	4	5	ON OFF	■	■	■	■	■		SLZ-M35FA	<table border="1"> <tr> <td>1</td><td>2</td><td>3</td><td>4</td><td>5</td> <td>ON OFF</td> </tr> <tr> <td>■</td><td>■</td><td>■</td><td>■</td><td>■</td> <td></td> </tr> </table>	1	2	3	4	5	ON OFF	■	■	■	■	■		SLZ-M50FA	<table border="1"> <tr> <td>1</td><td>2</td><td>3</td><td>4</td><td>5</td> <td>ON OFF</td> </tr> <tr> <td>■</td><td>■</td><td>■</td><td>■</td><td>■</td> <td></td> </tr> </table>	1	2	3	4	5	ON OFF	■	■	■	■	■		SLZ-M60FA	<table border="1"> <tr> <td>1</td><td>2</td><td>3</td><td>4</td><td>5</td> <td>ON OFF</td> </tr> <tr> <td>■</td><td>■</td><td>■</td><td>■</td><td>■</td> <td></td> </tr> </table>	1	2	3	4	5	ON OFF	■	■	■	■	■		
Model	Setting																																																																										
SLZ-M15FA	<table border="1"> <tr> <td>1</td><td>2</td><td>3</td><td>4</td><td>5</td> <td>ON OFF</td> </tr> <tr> <td>■</td><td>■</td><td>■</td><td>■</td><td>■</td> <td></td> </tr> </table>	1	2	3	4	5	ON OFF	■	■	■	■	■																																																															
1	2	3	4	5	ON OFF																																																																						
■	■	■	■	■																																																																							
SLZ-M25FA	<table border="1"> <tr> <td>1</td><td>2</td><td>3</td><td>4</td><td>5</td> <td>ON OFF</td> </tr> <tr> <td>■</td><td>■</td><td>■</td><td>■</td><td>■</td> <td></td> </tr> </table>	1	2	3	4	5	ON OFF	■	■	■	■	■																																																															
1	2	3	4	5	ON OFF																																																																						
■	■	■	■	■																																																																							
SLZ-M35FA	<table border="1"> <tr> <td>1</td><td>2</td><td>3</td><td>4</td><td>5</td> <td>ON OFF</td> </tr> <tr> <td>■</td><td>■</td><td>■</td><td>■</td><td>■</td> <td></td> </tr> </table>	1	2	3	4	5	ON OFF	■	■	■	■	■																																																															
1	2	3	4	5	ON OFF																																																																						
■	■	■	■	■																																																																							
SLZ-M50FA	<table border="1"> <tr> <td>1</td><td>2</td><td>3</td><td>4</td><td>5</td> <td>ON OFF</td> </tr> <tr> <td>■</td><td>■</td><td>■</td><td>■</td><td>■</td> <td></td> </tr> </table>	1	2	3	4	5	ON OFF	■	■	■	■	■																																																															
1	2	3	4	5	ON OFF																																																																						
■	■	■	■	■																																																																							
SLZ-M60FA	<table border="1"> <tr> <td>1</td><td>2</td><td>3</td><td>4</td><td>5</td> <td>ON OFF</td> </tr> <tr> <td>■</td><td>■</td><td>■</td><td>■</td><td>■</td> <td></td> </tr> </table>	1	2	3	4	5	ON OFF	■	■	■	■	■																																																															
1	2	3	4	5	ON OFF																																																																						
■	■	■	■	■																																																																							
J41 J42	Pair number setting with wireless remote controller	<table border="1"> <thead> <tr> <th rowspan="2">Wireless remote controller setting</th> <th colspan="2">Control PCB setting</th> </tr> <tr> <th>J41</th> <th>J42</th> </tr> </thead> <tbody> <tr> <td>0</td> <td>○</td> <td>○</td> </tr> <tr> <td>1</td> <td>×</td> <td>○</td> </tr> <tr> <td>2</td> <td>○</td> <td>×</td> </tr> <tr> <td>3 to 9</td> <td>×</td> <td>×</td> </tr> </tbody> </table>	Wireless remote controller setting	Control PCB setting		J41	J42	0	○	○	1	×	○	2	○	×	3 to 9	×	×	<p><Initial setting> Wireless remote controller: 0 Control PCB: ○ (for both J41 and J42) 4 pair number settings are supported. The pair number settings of the wireless remote controller and indoor control PCB (J41/J42) are given in the table on the left. (' × ' in the table indicates the jumper wire is disconnected.)</p>																																																							
Wireless remote controller setting	Control PCB setting																																																																										
	J41	J42																																																																									
0	○	○																																																																									
1	×	○																																																																									
2	○	×																																																																									
3 to 9	×	×																																																																									

9-7. TROUBLE CRITERION OF MAIN PARTS

SLZ-M15FA.TH SLZ-M25FA.TH SLZ-M35FA.TH SLZ-M50FA.TH SLZ-M60FA.TH
 SLZ-M15FA.TH-ER SLZ-M25FA.TH-ER SLZ-M35FA.TH-ER SLZ-M50FA.TH-ER SLZ-M60FA.TH-ER

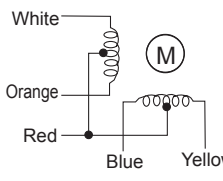
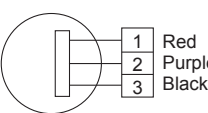
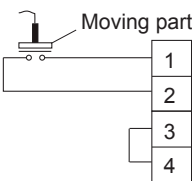
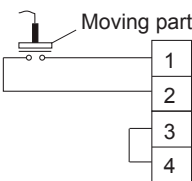
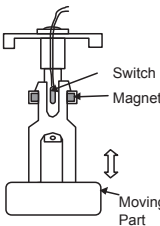
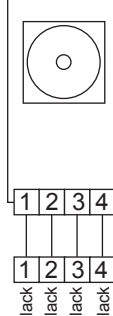
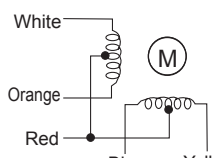
Parts name	Check method and criterion																	
Room temperature thermistor (TH1)	Measure the resistance with a tester. (Parts temperature 10 to 30°C)																	
Pipe temperature thermistor/liquid (TH2)					Normal		Abnormal											
Condenser/evaporator temperature thermistor (TH5)					4.3 to 9.6 kΩ		Opened or short-circuited											
Vane motor (MV)	Measure the resistance between the terminals with a tester. (At the ambient temperature 20 to 30°C)																	
	Connector		Normal	Abnormal														
	Red–Yellow (5–3, 10–8, 15–13, 20–18)		300 Ω	Open or short														
	Red–Blue (5–1, 10–6, 15–11, 20–16)																	
	Red–Orange (5–4, 10–9, 15–14, 20–19)																	
	Red–White (5–2, 10–7, 15–12, 20–17)																	
Drain pump (DP)	<ol style="list-style-type: none"> Check if the drain float switch works properly. Check if the drain pump works and drains water properly in cooling operation. If no water drains, confirm that the check code P5 will not be displayed 10 minutes after the operation starts. Note: The drain pump for this model is driven by the internal DC motor of controller board, so it is not possible to measure the resistance between the terminals. Normal Red–Black: Input 13 V DC → The fan starts to rotate. Purple–Black: Abnormal (check code P5) if it outputs 0–13 V square wave (5 pulses/rotation), and the number of rotation is not normal.																	
	Drain float switch (FS)																	
			Measure the resistance between the terminals with a tester.															
		<table border="1"> <thead> <tr> <th>State of moving part</th> <th>Normal</th> <th>Abnormal</th> </tr> </thead> <tbody> <tr> <td>UP</td> <td>Short</td> <td>Other than short</td> </tr> <tr> <td>DOWN</td> <td>Open</td> <td>Other than open</td> </tr> </tbody> </table>		State of moving part	Normal	Abnormal	UP	Short	Other than short	DOWN	Open	Other than open						
State of moving part	Normal	Abnormal																
UP	Short	Other than short																
DOWN	Open	Other than open																
i-See sensor *	Turn the power ON while the i-see sensor connector is connected to the CN4Z on indoor controller board. A communication between the indoor controller board and i-see sensor board is made to detect the connection. Normal: When the operation starts, the motor for i-see sensor is driven to rotate the i-see sensor. Abnormal: The motor for i-see sensor is not driven when the operation starts. Note: The voltage between the terminals cannot be measured accurately since it is pulse output.																	
	i-See sensor motor *																	
			Measure the resistance between the terminals with a tester. (At the ambient temperature 20 to 30°C)															
		<table border="1"> <thead> <tr> <th colspan="4">Normal</th> <th>Abnormal</th> </tr> </thead> <tbody> <tr> <td>Red–Yellow</td> <td>Red–Blue</td> <td>Red–Orange</td> <td>Red–White</td> <td rowspan="2">Open or short</td> </tr> <tr> <td colspan="4">250 Ω</td> </tr> </tbody> </table>		Normal				Abnormal	Red–Yellow	Red–Blue	Red–Orange	Red–White	Open or short	250 Ω				
Normal				Abnormal														
Red–Yellow	Red–Blue	Red–Orange	Red–White	Open or short														
250 Ω																		

* i-See sensor is available with optional “i-see sensor corner panel” (SLP-2FAE, SLP-2FALE, and SLP-2FALME).

9-7-1. Thermistor Characteristic Graph

Thermistor for lower temperature

- Room temperature thermistor (TH1)
- Pipe temperature thermistor/liquid (TH2)
- Condenser/evaporator temperature thermistor (TH5)

Thermistor $R_0=15\text{ k}\Omega \pm 3\%$
 Fixed number of $B=3480 \pm 2\%$

$$R_t = 15 \exp \left\{ 3480 \left(\frac{1}{273+t} - \frac{1}{273} \right) \right\}$$

0°C	15 kΩ
10°C	9.6 kΩ
20°C	6.3 kΩ
25°C	5.2 kΩ
30°C	4.3 kΩ
40°C	3.0 kΩ

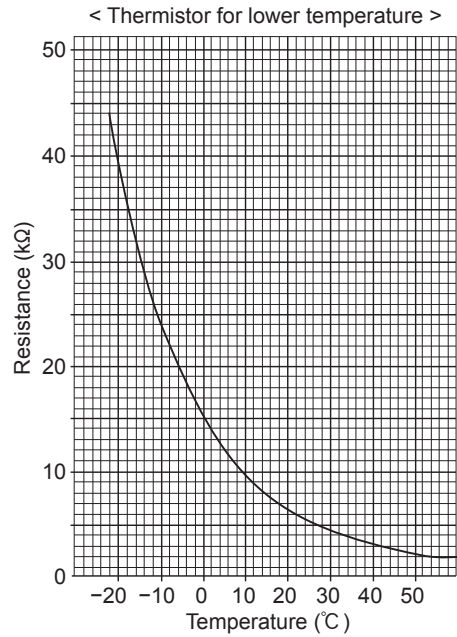

9-7-2. DC Fan Motor (Fan Motor/Indoor Controller Board)

Check method of DC fan motor (fan motor/indoor controller circuit board)

① Notes

- High voltage is applied to the connector (CNMF) for the fan motor. Pay attention to the service.
- Do not pull out the connector (CNMF) for the motor with the power supply on.
 (It causes trouble of the indoor controller circuit board and fan motor.)

② Self check

Symptom : The indoor fan cannot rotate.

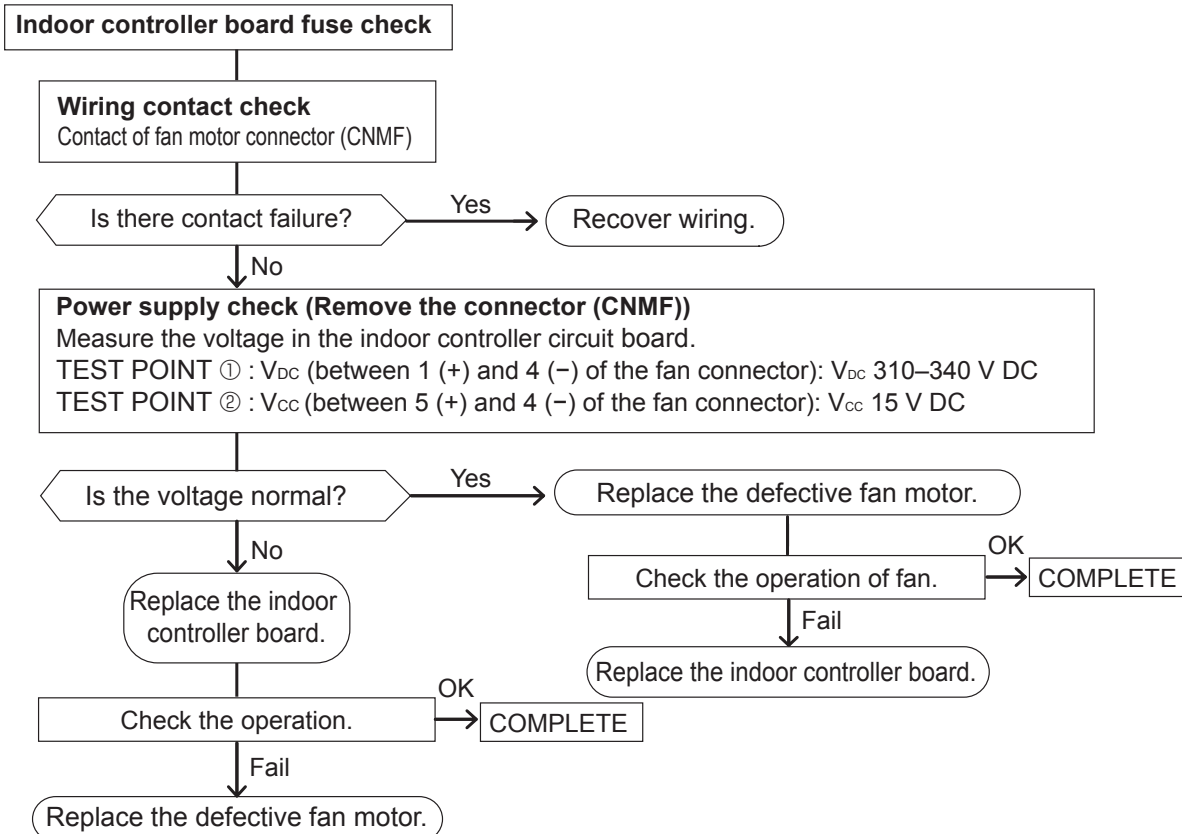

10-1. FRESH AIR INTAKE (LOCATION FOR INSTALLATION)

At the time of installation, use the duct holes (cut out) located at the positions shown in following diagram, as and when required.

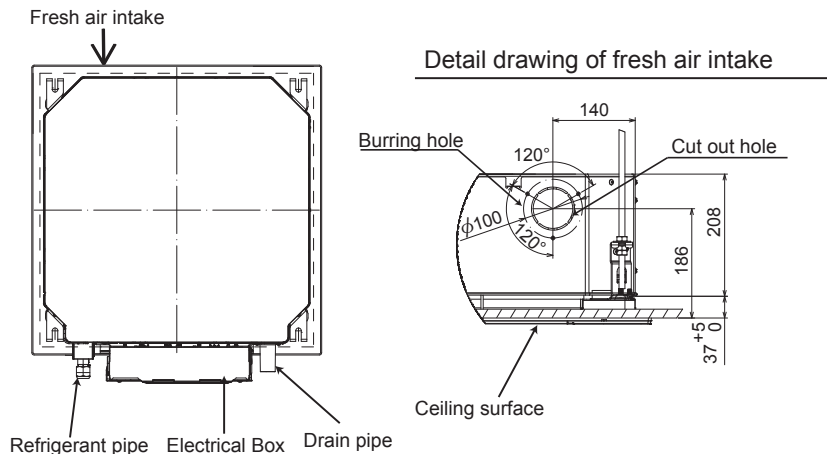

10-2. FRESH AIR INTAKE AMOUNT & STATIC PRESSURE CHARACTERISTICS

Taking air into the unit

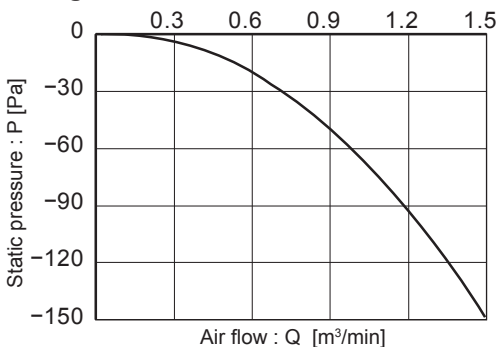

NOTE: Fresh air intake amount should be 10% or less of whole air amount to prevent dew dripping.

How to read curves

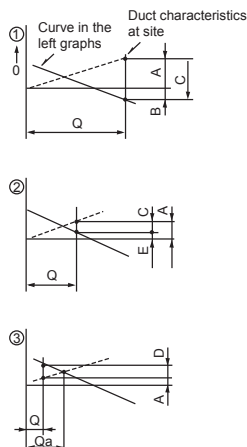

- Q...Designed amount of fresh air intake $\lt; m^3/min >$
- A...Static pressure loss of fresh air intake duct system with air flow amount Q $\lt; Pa >$
- B...Forced static pressure at air conditioner inlet with air flow amount Q $\lt; Pa >$
- C...Static pressure of booster fan with air flow amount Q $\lt; Pa >$
- D...Static pressure loss increase amount of fresh air intake duct system for air flow amount Q $\lt; Pa >$
- E...Static pressure of indoor unit with air flow amount Q $\lt; Pa >$
- Qa...Estimated amount of fresh air intake without D $\lt; m^3/min >$

10-3. OPERATION IN CONJUNCTION WITH DUCT FAN (BOOSTER FAN)

- Whenever the indoor unit operates, the duct fan operates.
- (1) Connect the optional multiple remote controller adapter (PAC-SA88HA-E) to the connector CN51 on the indoor controller board.
- (2) Drive the relay after connecting the 12 V DC relay between the Yellow and Orange connector wires. Use a relay of 1W or smaller. MB: Electromagnetic switch power relay for duct fan. X: Auxiliary relay (12 V DC LY-1F)

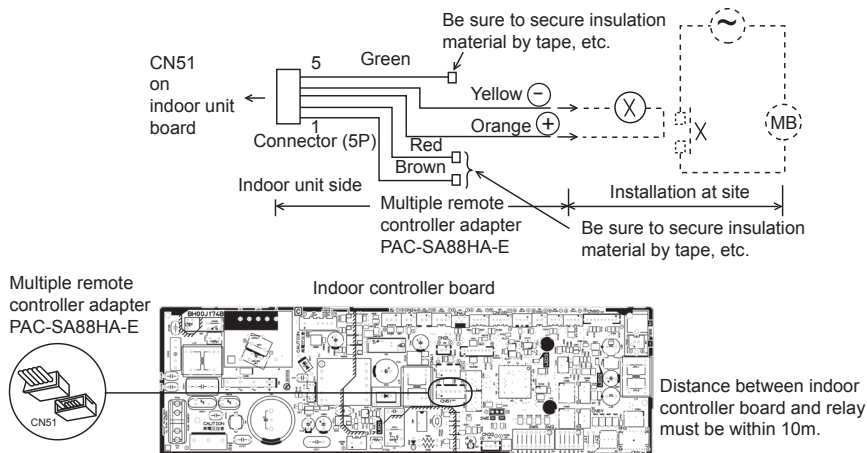

10-4. FIXING HORIZONTAL VANE

Horizontal vane of each air outlet can be fixed according to the environment where it is installed.

Setting procedure

- 1) Turn off a main power supply (Turn off a breaker).
- 2) Remove the vane motor connector in the direction of the arrow shown below with pressing the unlocking button as in the figure below.
Insulate the disconnected connector with the plastic tape.

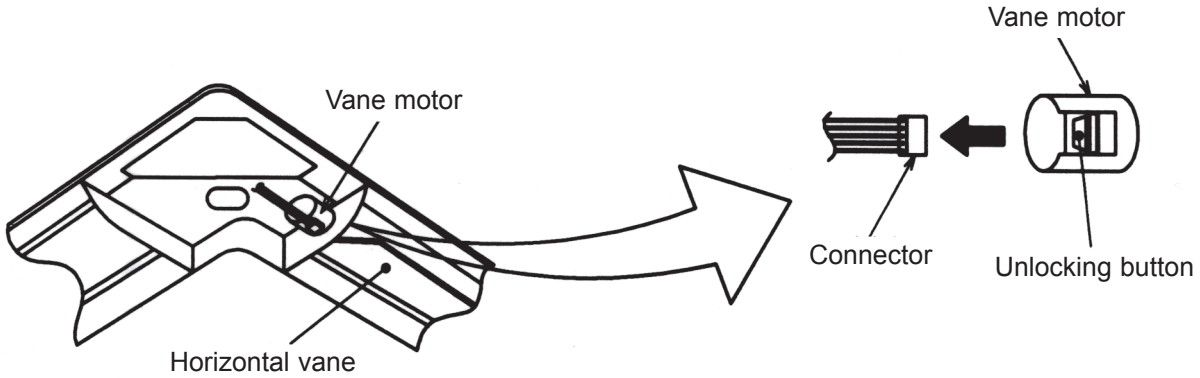

- 3) Set the vertical vane of the air outlet by hand slowly within the range in the table below.

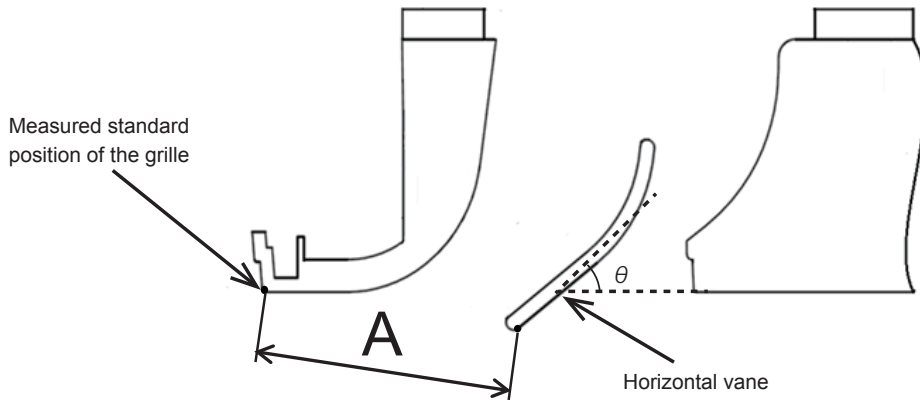

<Set range>

Standard of horizontal position	Angle $\theta = 21^\circ$ (Horizontal)	Angle $\theta = 24^\circ$	Angle $\theta = 39^\circ$	Angle $\theta = 42^\circ$	Angle $\theta = 45^\circ$ (Downward)
Dimension A (mm)	39	41	47	48	49

Note: Dimension between 39 mm and 49 mm can be arbitrarily set.

Caution 	Do not set the dimension out of the range.
	Erroneous setting could cause dew drips or malfunction of unit.

SLZ-M15FA.TH SLZ-M25FA.TH SLZ-M35FA.TH SLZ-M50FA.TH SLZ-M60FA.TH
 SLZ-M15FA.TH-ER SLZ-M25FA.TH-ER SLZ-M35FA.TH-ER SLZ-M50FA.TH-ER SLZ-M60FA.TH-ER

Be careful when removing heavy parts.

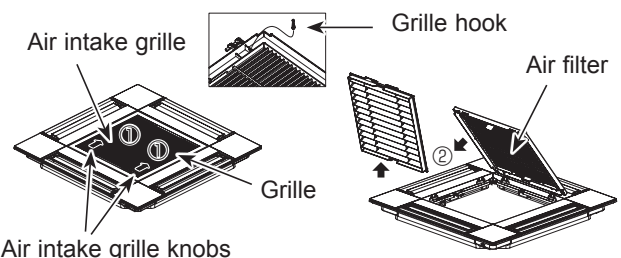
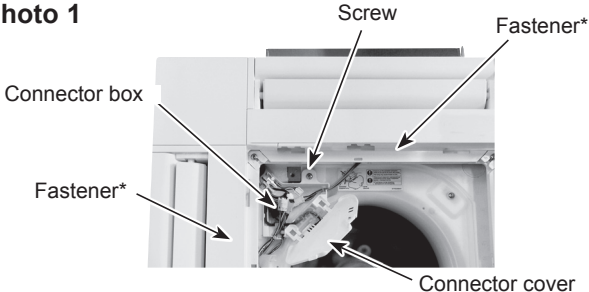
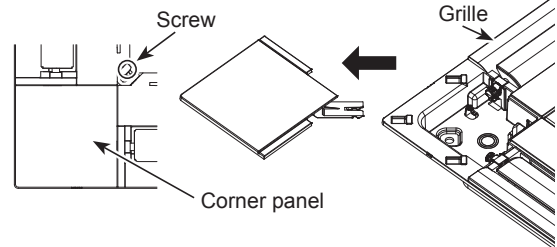
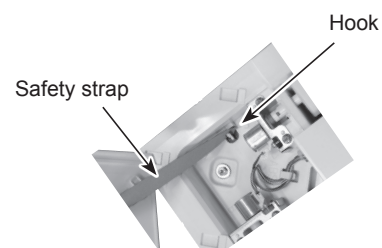
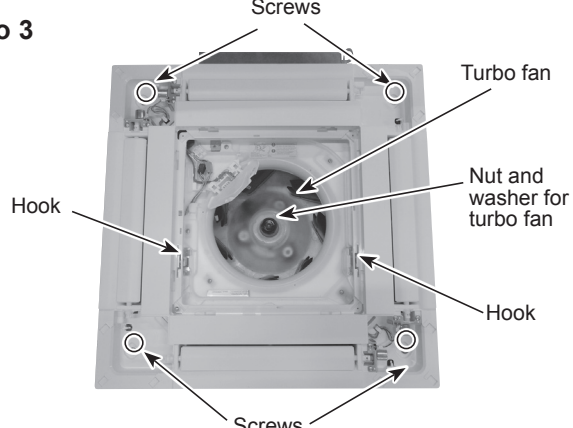
OPERATING PROCEDURE	PHOTOS/FIGURES
<p>1. Removing the air intake grille and air filter</p> <ol style="list-style-type: none"> (1) Slide the knob of air intake grille to the direction of the arrow ① to open the air intake grille. (2) Remove the grille hook from the panel to prevent the grille from dropping. (3) Slide the hinge of the intake grille to the direction of the arrow ② and remove the air filter. 	<p>Figure 1</p> 
<p>2. Removing the panel</p> <ol style="list-style-type: none"> (1) Remove the air intake grille. (Refer to procedure 1) <p>Connector box (See Photo 1)</p> <ol style="list-style-type: none"> (2) Remove the screw of the connector cover. (3) Slide the connector cover to the direction of the arrow to open the cover. (4) Disconnect all the connectors, then pull out the connectors that are coming from panel side from the connector box. <p>Corner panel (See Figure 2 and Photo 2)</p> <ol style="list-style-type: none"> (5) Loosen the screw from the corner of the corner panel. (6) Slide the corner panel as indicated by the arrow. (7) Remove the safety strap from the hook, then remove the corner panel from the panel. (The safety strap is not equipped for the signal receiver panel and i-See sensor corner panel.) (8) Remove the fastener (*), then remove the corner panel. <p>Panel (See Photo 3)</p> <ol style="list-style-type: none"> (9) Remove the 4 screws. (10) Unlatch the 2 hooks. <p>*Fastener is only for the signal receiver and i-See sensor corner panel.</p>	<p>Photo 1</p>  <p>Figure 2</p>  <p>Photo 2</p>  <p>Photo 3</p> 



OPERATING PROCEDURE

PHOTOS/FIGURES

3. Removing the electrical parts

(1) Loosen the 2 screws on the control box cover.
 (2) Slide the control box cover as indicated by the arrow to remove.
 <Electrical parts in the control box>

- Indoor controller board (I.B)
- Terminal block (TB4)
- Terminal block (TB5)

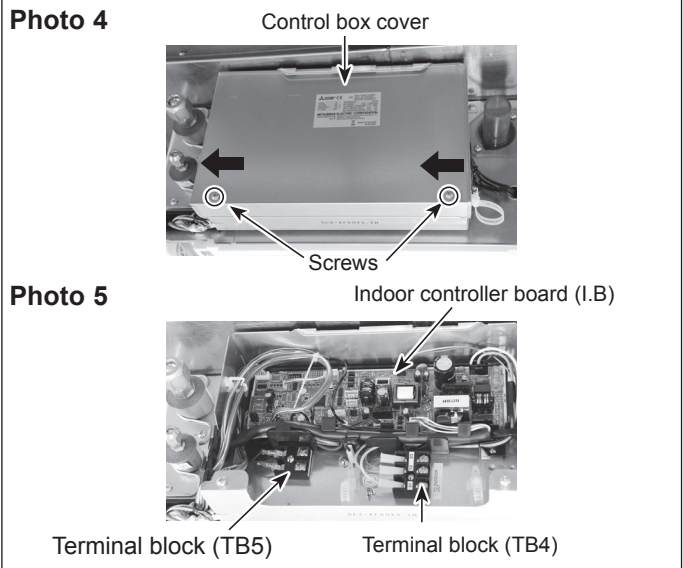

4. Removing the room temperature thermistor (TH1)

(1) Remove the panel. (Refer to procedure 2)

Room temperature thermistor (TH1) (See Photo 6)

(2) Remove the 2 lead wire cover fixing screws. (See Photo 6)
 (3) Open the lead wire cover, then remove the connector cover from the connector box.
 (4) Remove the band that fixes the room temperature thermistor (TH1) to the connector box.
 (5) Remove the room temperature thermistor (TH1) from the connector box.
 (6) Remove the connector (CN20) from the indoor controller board, and disconnect the room temperature thermistor (TH1).

Note: When fixing the thermistor, make sure to fix it to the connector box using a band.

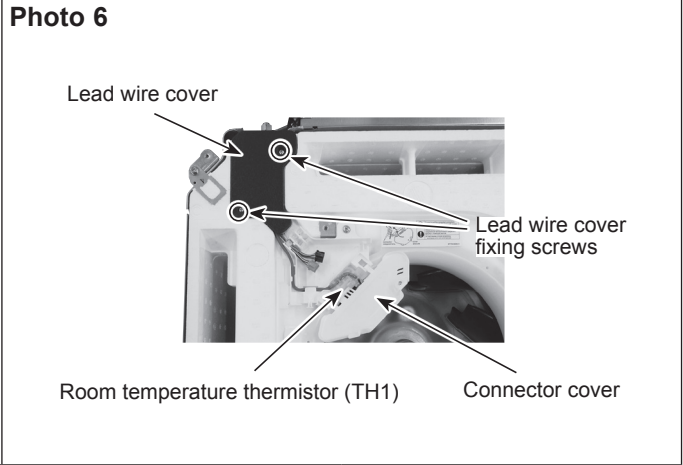

5. Removing the drain pan

(1) Remove the panel. (Refer to procedure 2)
 (2) Remove the room temperature thermistor (TH1). (Refer to procedure 4)

Connector box (See Photo 7)

(3) Remove the connector box fixing screw.
 (4) Slide the connector box as indicated by the arrow 1, then remove from bell mouth.

Bell mouth (See Photo 7)

(5) Remove the 4 bell mouth fixing screws, then remove the bell mouth.

Drain pan (See Photo 7)

(6) Remove the 4 drain pan fixing screws, then remove the drain pan.

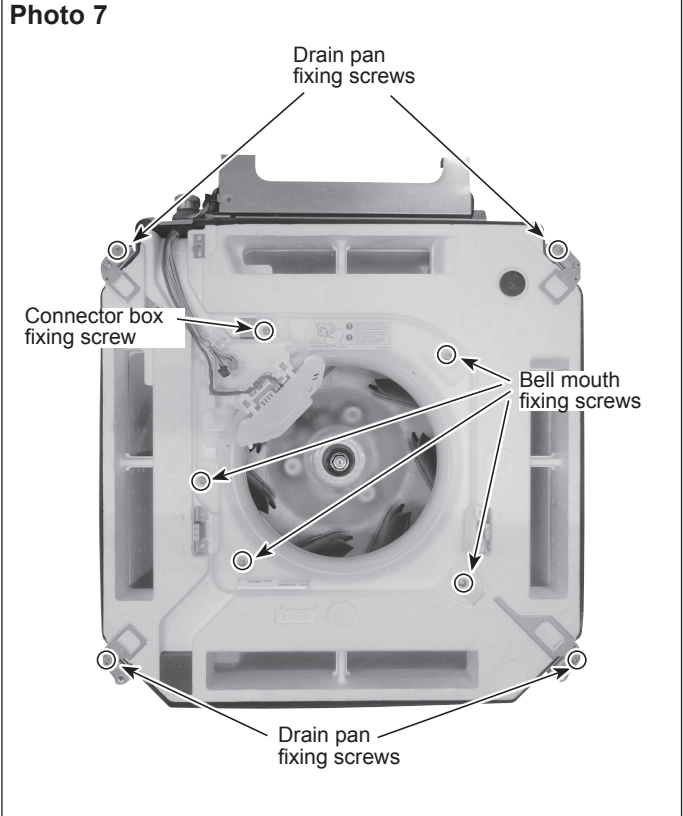

OPERATING PROCEDURE

6. Removing the pipe temperature thermistor/liquid (TH2) and condenser / evaporator temp. thermistor (TH5)

- (1) Remove the panel. (Refer to procedure 2)
- (2) Remove the room temperature thermistor (TH1). (Refer to procedure 4)
- (3) Remove the drain pan. (Refer to procedure 5)

Pipe temperature thermistor/liquid (TH2) and condenser / evaporator temp. thermistor (TH5) (See Photo 8)

- (4) Remove the control box cover. (Refer to procedure 3)
- (5) Disconnect the thermistor connectors from the CN44 on the indoor controller board.
- (6) Cut the band fixing the thermistor connectors to the fan motor cable.
- (7) Remove the thermistors from the holders on heat exchanger.

Note:

When re-attaching the thermistor connectors to the fan motor cable, make sure to put the fixed band into the groove. (See Photo 8-1)

PHOTOS/FIGURES

Photo 8

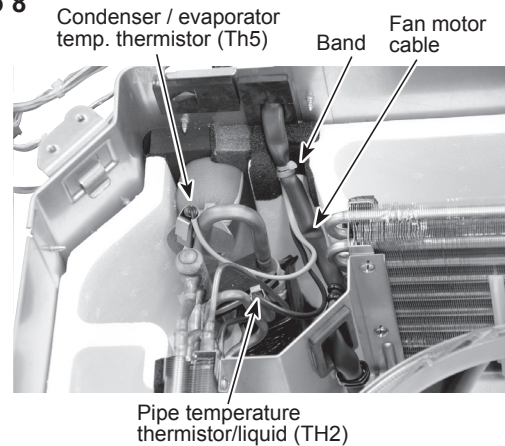
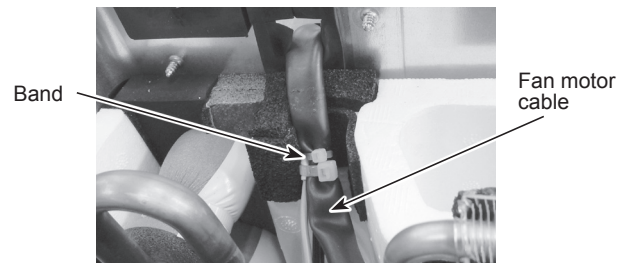

Photo 8-1



7. Removing the fan motor (MF)

- (1) Remove the panel. (Refer to procedure 2)
- (2) Remove the room temperature thermistor (TH1). (Refer to procedure 4)
- (3) Remove the drain pan. (Refer to procedure 5)

Turbo fan (See Photo 3)

- (4) Remove the nut and washer from the turbo fan.
- (5) Remove the turbo fan from the motor shaft.

Fan motor (See Photo 9)

- (6) Remove the control box cover. (Refer to procedure 3)
- (7) Disconnect the fan motor cable from the CNMF on the indoor controller board.
- (8) Remove the 2 motor lead cover fixing screws, then remove the motor lead cover.
- (9) Loosen the 3 clamps fixing the fan motor cable.
- (10) Cut the band.
- (11) Remove the 3 nuts and washers, then remove the fan motor.
- (12) Remove the 3 motor mounts.

Notes:

1. When re-attaching the motor mount, make sure that the thicker end faces the motor shaft. (See Photo 10-1)
2. When re-attaching the turbo fan, make sure that the tightening torque for nuts is 5 N·m or lower.

Photo 9

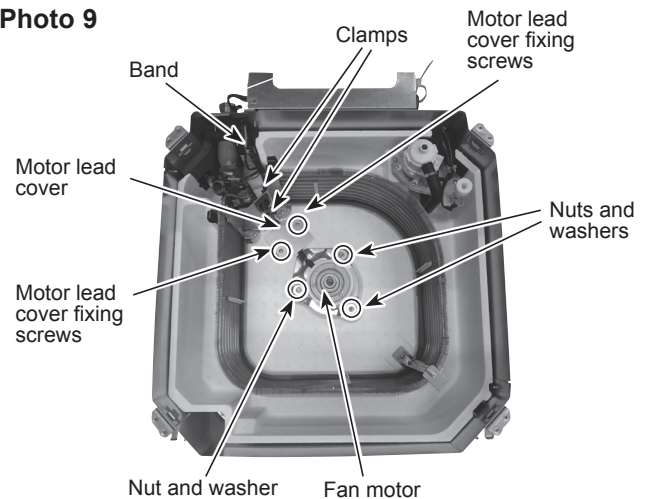

Photo 10

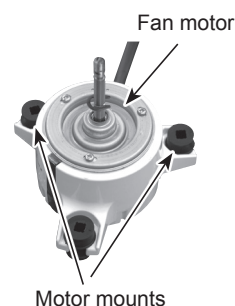
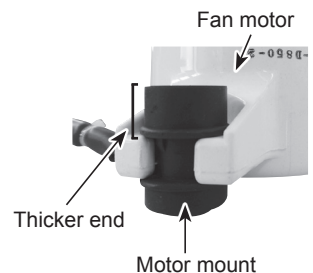

Photo 10-1



OPERATING PROCEDURE

8. Removing the drain pump (DP) and float switch (FS)

- (1) Remove the panel. (Refer to procedure 2)
- (2) Remove the room temperature thermistor (TH1). (Refer to procedure 4)
- (3) Remove the control box cover. (Refer to procedure 3)
- (4) Remove the drain pan. (Refer to procedure 5)

Drain pump (See Photo 11 and 12)

- (5) Disconnect the drain pump connector from the CNP and float switch connector from CN4F on the indoor controller board.
- (6) Loosen the clamp fixing the connectors on the side of the control box.
- (7) Cut the hose band and release the hose.
- (8) Remove the 2 screws fixing the drain pump and float switch to the inner cover.
- (9) Slide the base plate of the drain pump and float switch as indicated by the arrow ① to remove.
- (10) Cut the band. (See Photo 12)
- (11) Remove the 3 drain pump fixing screws, then remove the drain pump. (See Photo 12)

Notes:

1. When re-attaching the drain pump, make sure to use a band to fix the connector to the base plate.
2. Do not give a shock to the float switch. Otherwise it can cause damage or malfunction.

9. Removing the heat exchanger

- (1) Remove the panel. (Refer to procedure 2)
- (2) Remove the room temperature thermistor (TH1). (Refer to procedure 4)
- (3) Remove the drain pan. (Refer to procedure 5)
- (4) Remove the turbo fan and fan motor. (Refer to procedure 7)

Heat exchanger (See Photo 13 and 14)

- (5) Remove the 3 pipe cover fixing screws to remove the pipe cover.
- (6) Remove the 2 coil plate fixing screws.
- (7) Remove the coil support fixing screw, then remove the coil support.
- (8) Remove the heat exchanger.

PHOTOS/FIGURES

Photo 11

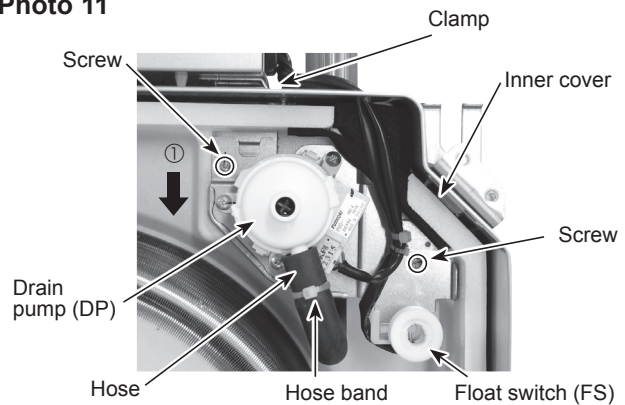

Photo 12

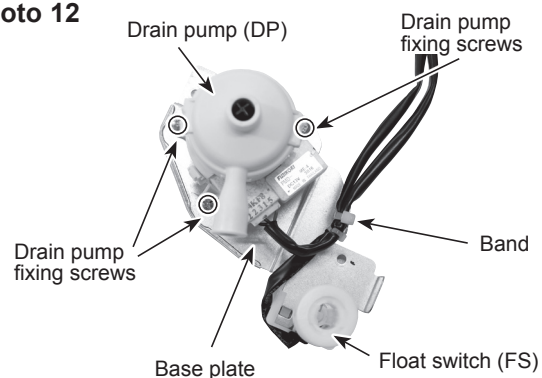

Photo 13

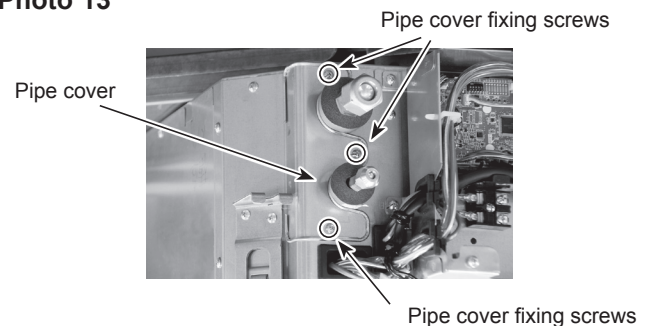
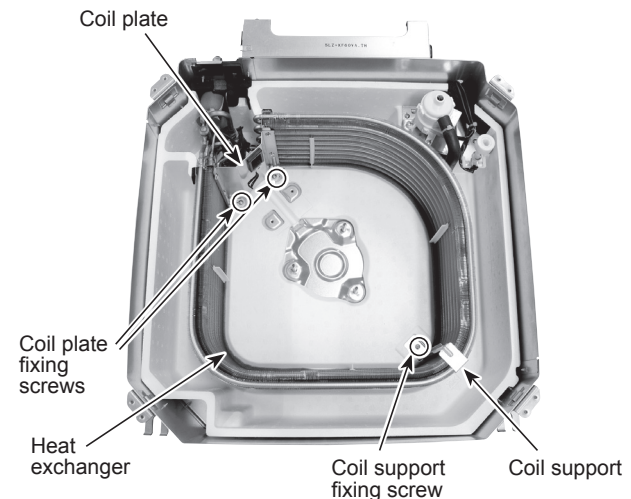

Photo 14



Mr. SLIM

mitsubishi electric corporation

HEAD OFFICE : TOKYO BUILDING, 2-7-3, MARUNOUCHI, CHIYODA-KU, TOKYO 100-8310, JAPAN
